

# High-Gain IGBTs w/Diode

# IXGH50N60B4D1 IXGQ50N60B4D1

$V_{CES} = 600V$   
 $I_{C110} = 50A$   
 $V_{CE(sat)} \leq 1.8V$

## Low-Vsat PT Trench IGBTs

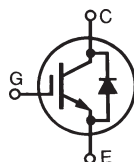

TO-247 (IXGH)

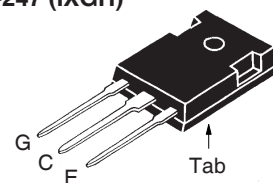

TO-3P (IXGQ)

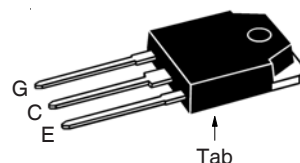

G = Gate                      C = Collector  
 E = Emitter                  Tab = Collector

Symbol	Test Conditions	Maximum Ratings	
$V_{CES}$	$T_J = 25^\circ C$ to $150^\circ C$	600	V
$V_{CGR}$	$T_J = 25^\circ C$ to $150^\circ C$ , $R_{GE} = 1M\Omega$	600	V
$V_{GES}$	Continuous	$\pm 20$	V
$V_{GEM}$	Transient	$\pm 30$	V
$I_{C25}$	$T_C = 25^\circ C$	100	A
$I_{C110}$	$T_C = 110^\circ C$	50	A
$I_{F110}$	$T_C = 110^\circ C$	18	A
$I_{CM}$	$T_C = 25^\circ C$ , 1ms	230	A
<b>SSOA</b> <b>(RBSOA)</b>	$V_{GE} = 15V$ , $T_{VJ} = 125^\circ C$ , $R_G = 10\Omega$ Clamped Inductive Load	$I_{CM} = 72$ $V_{CE} \leq V_{CES}$	A
$P_C$	$T_C = 25^\circ C$	300	W
$T_J$		-55 ... +150	$^\circ C$
$T_{JM}$		150	$^\circ C$
$T_{stg}$		-55 ... +150	$^\circ C$
$T_L$	Maximum Lead Temperature for Soldering	300	$^\circ C$
$T_{SOLD}$	1.6 mm (0.062in.) from Case for 10s	260	$^\circ C$
$M_d$	Mounting Torque	1.13/10	Nm/lb.in.
<b>Weight</b>	TO-247	6.0	g
	TO-3P	5.5	g

## Features

- Optimized for Low Conduction and Switching Losses
- Anti-Parallel Ultra Fast Diode
- Square RBSOA

## Advantages

- Easy to Mount
- Space Savings

## Applications

- Power Inverters
- UPS
- Motor Drives
- SMPS
- PFC Circuits
- Battery Chargers
- Lamp Ballasts

Symbol	Test Conditions ( $T_J = 25^\circ C$ , Unless Otherwise Specified)	Characteristic Values		
		Min.	Typ.	Max.
$V_{GE(th)}$	$I_C = 250\mu A$ , $V_{CE} = V_{GE}$	4.0		6.5 V
$I_{CES}$	$V_{CE} = V_{CES}$ , $V_{GE} = 0V$ $T_J = 125^\circ C$			50 $\mu A$ 2.5 mA
$I_{GES}$	$V_{CE} = 0V$ , $V_{GE} = \pm 20V$			$\pm 100$ nA
$V_{CE(sat)}$	$I_C = 36A$ , $V_{GE} = 15V$ , Note 1 $T_J = 125^\circ C$		1.4 1.4	1.8 V V

**Symbol Test Conditions**
 $(T_J = 25^\circ\text{C Unless Otherwise Specified})$ 
**Characteristic Values**

		Min.	Typ.	Max.	
$g_{fs}$	$I_C = 36\text{A}, V_{CE} = 10\text{V}, \text{Note 1}$	20	30		S
$C_{ies}$	$V_{CE} = 25\text{V}, V_{GE} = 0\text{V}, f = 1\text{MHz}$		1860		pF
$C_{oes}$			105		pF
$C_{res}$			60		pF
$Q_g$	$I_C = I_{C110}, V_{GE} = 15\text{V}, V_{CE} = 0.5 \cdot V_{CES}$		110		nC
$Q_{ge}$			13		nC
$Q_{gc}$			43		nC
$t_{d(on)}$	<b>Inductive Load, <math>T_J = 25^\circ\text{C}</math></b> $I_C = 36\text{A}, V_{GE} = 15\text{V}$ $V_{CE} = 400\text{V}, R_G = 10\Omega$ Note 2		37		ns
$t_{ri}$			68		ns
$E_{on}$			0.93		mJ
$t_{d(off)}$			330		ns
$t_{fi}$			80		ns
$E_{off}$			1.00	1.80	mJ
$t_{d(on)}$	<b>Inductive Load, <math>T_J = 125^\circ\text{C}</math></b> $I_C = 36\text{A}, V_{GE} = 15\text{V}$ $V_{CE} = 400\text{V}, R_G = 10\Omega$ Note 2		31		ns
$t_{ri}$			45		ns
$E_{on}$			0.94		mJ
$t_{d(off)}$			280		ns
$t_{fi}$			220		ns
$E_{off}$			1.90		mJ
$R_{thJC}$				0.42	$^\circ\text{C/W}$
$R_{thCS}$		0.25			$^\circ\text{C/W}$

**Reverse Diode (FRED)**
**Symbol Test Conditions**
 $(T_J = 25^\circ\text{C Unless Otherwise Specified})$ 
**Characteristic Values**

		Min.	Typ.	Max.	
$V_F$	$I_F = 15\text{A}, V_{GE} = 0\text{V}, \text{Note 1}$			2.7	V
			$T_J = 150^\circ\text{C}$	1.6	V
$I_{RM}$	$I_F = 15\text{A}, V_{GE} = 0\text{V}, -di_F/dt = 100\text{A}/\mu\text{s},$		$T_J = 100^\circ\text{C}$		2.6
$t_{rr}$	$V_R = 100\text{V}$		$T_J = 100^\circ\text{C}$	100	ns
	$I_F = 1\text{A}, V_{GE} = 0\text{V}, -di_F/dt = 100\text{A}/\mu\text{s}, V_R = 30\text{V}$			25	ns
$R_{thJC}$					1.6 $^\circ\text{C/W}$

**Notes:**

1. Pulse test,  $t \leq 300\mu\text{s}$ , duty cycle,  $d \leq 2\%$ .
2. Switching times & energy losses may increase for higher  $V_{CE}(\text{clamp})$ ,  $T_J$  or  $R_G$ .

IXYS Reserves the Right to Change Limits, Test Conditions, and Dimensions.

IXYS MOSFETs and IGBTs are covered by one or more of the following U.S. patents:	4,835,592	4,931,844	5,049,961	5,237,481	6,162,665	6,404,065 B1	6,683,344	6,727,585	7,005,734 B2	7,157,338B2
	4,850,072	5,017,508	5,063,307	5,381,025	6,259,123 B1	6,534,343	6,710,405 B2	6,759,692	7,063,975 B2	
	4,881,106	5,034,796	5,187,117	5,486,715	6,306,728 B1	6,583,505	6,710,463	6,771,478 B2	7,071,537	

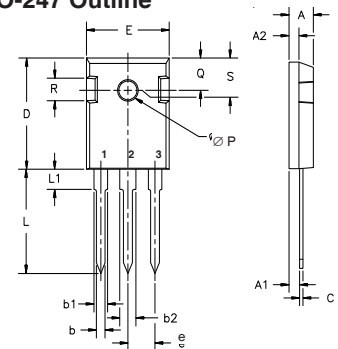
**TO-247 Outline**

 Terminals: 1 - Gate 2 - Collector  
 3 - Emitter

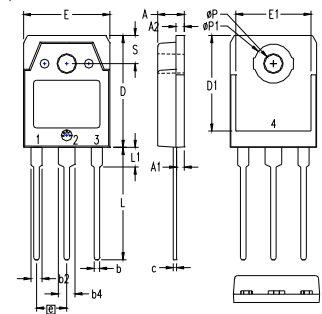
Dim.	Millimeter		Inches	
	Min.	Max.	Min.	Max.
A	4.7	5.3	.185	.209
A <sub>1</sub>	2.2	2.54	.087	.102
A <sub>2</sub>	2.2	2.6	.059	.098
b	1.0	1.4	.040	.055
b <sub>1</sub>	1.65	2.13	.065	.084
b <sub>2</sub>	2.87	3.12	.113	.123
C	.4	.8	.016	.031
D	20.80	21.46	.819	.845
E	15.75	16.26	.610	.640
e	5.20	5.72	0.205	0.225
L	19.81	20.32	.780	.800
L1		4.50		.177
∅P	3.55	3.65	.140	.144
Q	5.89	6.40	0.232	0.252
R	4.32	5.49	.170	.216
S	6.15	BSC	242	BSC

**TO-3P Outline**

 1 = Gate 2,4 = Collector  
 3 = Emitter

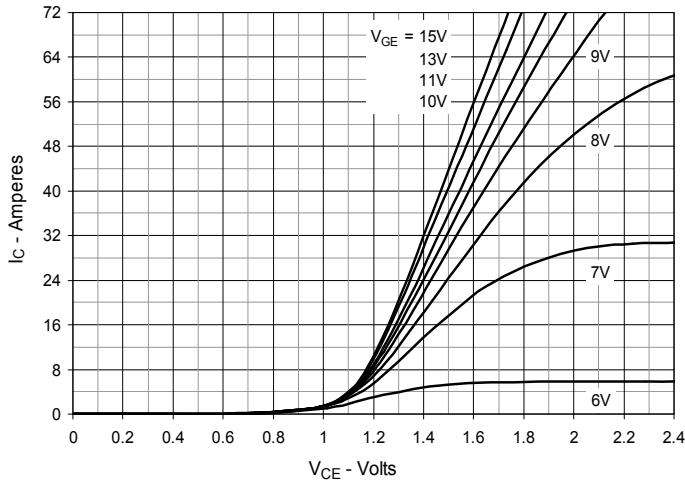
SYM	INCHES		MILLIMETERS	
	MIN	MAX	MIN	MAX
A	.185	.193	4.70	4.90
A1	.051	.059	1.30	1.50
A2	.057	.065	1.45	1.65
b	.035	.045	0.90	1.15
b2	.075	.087	1.90	2.20
b4	.114	.126	2.90	3.20
c	.022	.031	0.55	0.80
D	.780	.799	19.80	20.30
D1	.665	.677	16.90	17.20
E	.610	.622	15.50	15.80
E1	.531	.539	13.50	13.70
e	.215 BSC		5.45 BSC	
L	.779	.795	19.80	20.20
L1	.134	.142	3.40	3.60
∅P	.126	.134	3.20	3.40
∅P1	.272	.280	6.90	7.10
S	.193	.201	4.90	5.10

**Fig. 1. Output Characteristics @  $T_J = 25^\circ\text{C}$**

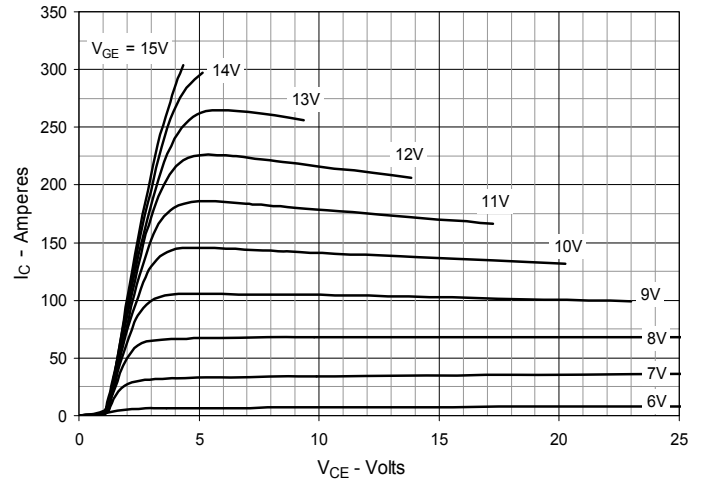

**Fig. 2. Extended Output Characteristics @  $T_J = 25^\circ\text{C}$**



**Fig. 3. Output Characteristics @  $T_J = 125^\circ\text{C}$**

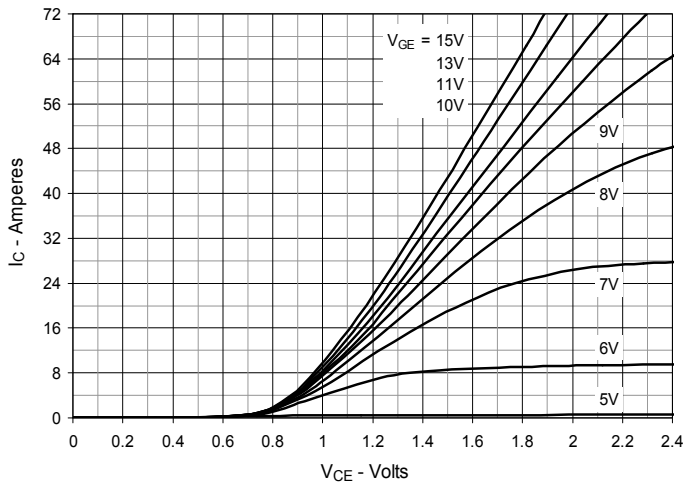

**Fig. 4. Dependence of  $V_{CE(sat)}$  on Junction Temperature**

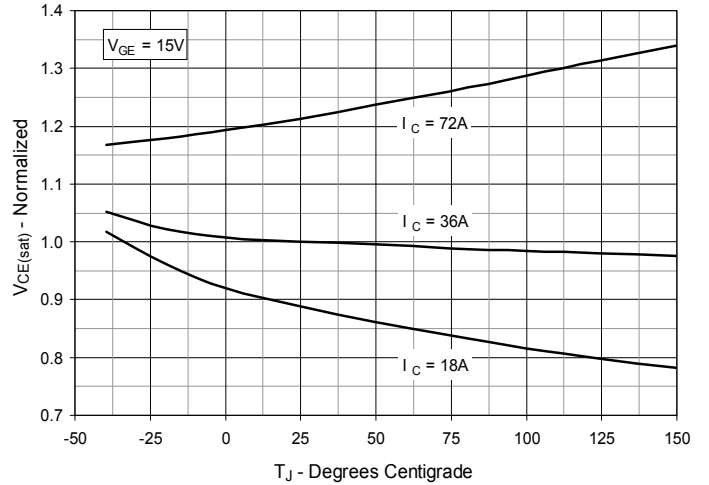

**Fig. 5. Collector-to-Emitter Voltage vs. Gate-to-Emitter Voltage**

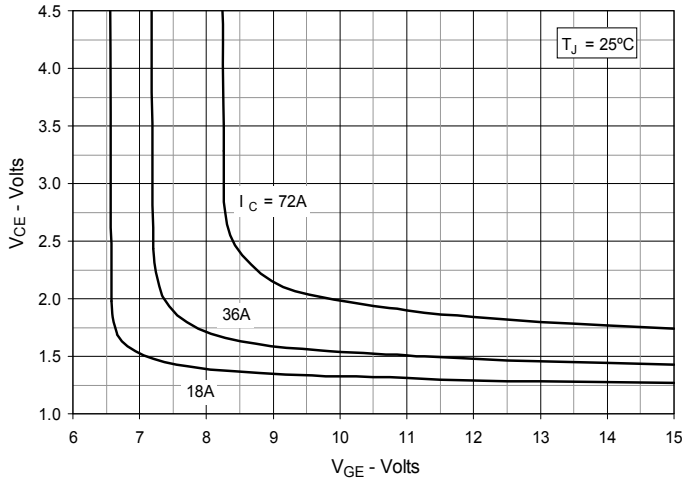

**Fig. 6. Input Admittance**

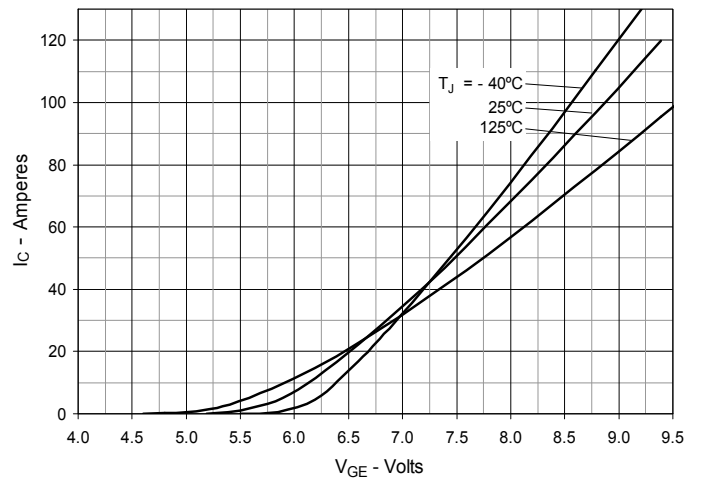

Fig. 7. Transconductance

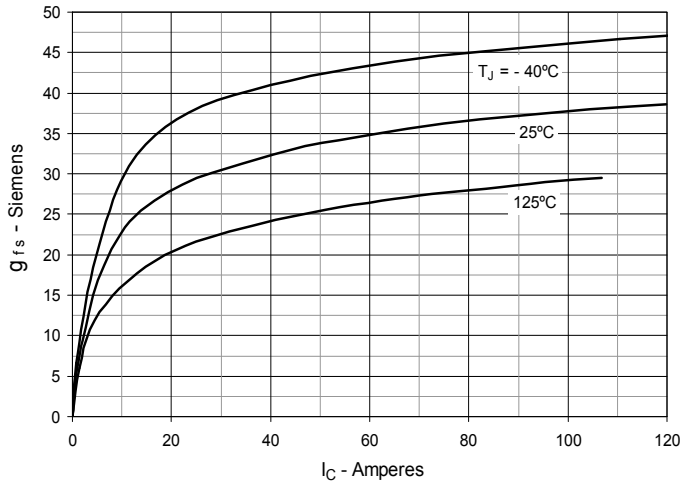

Fig. 8. Gate Charge

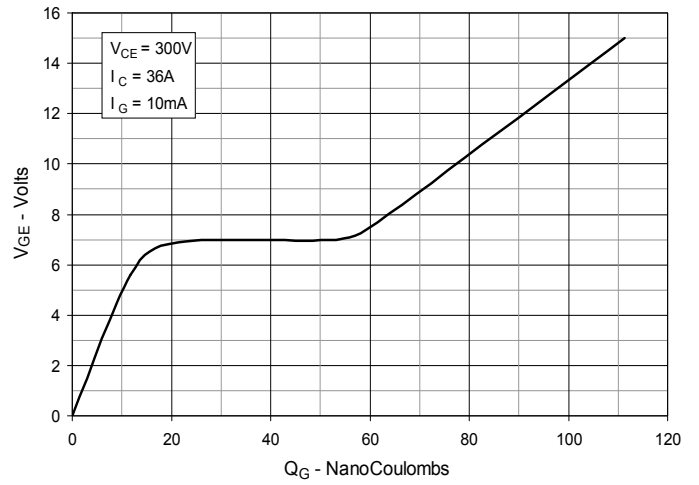

Fig. 9. Capacitance

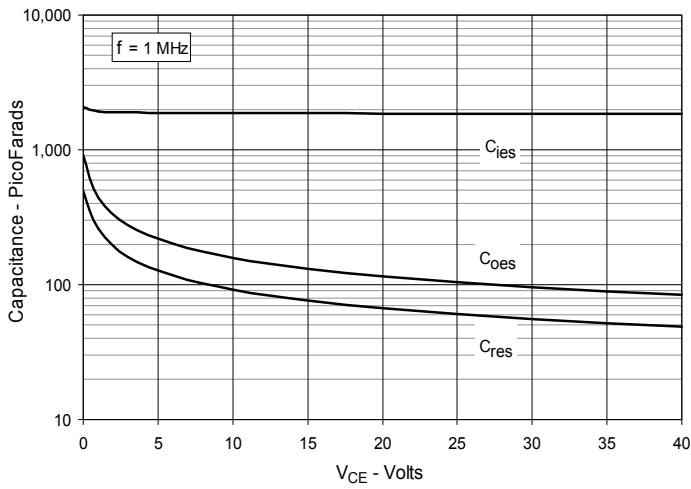

Fig. 10. Reverse-Bias Safe Operating Area

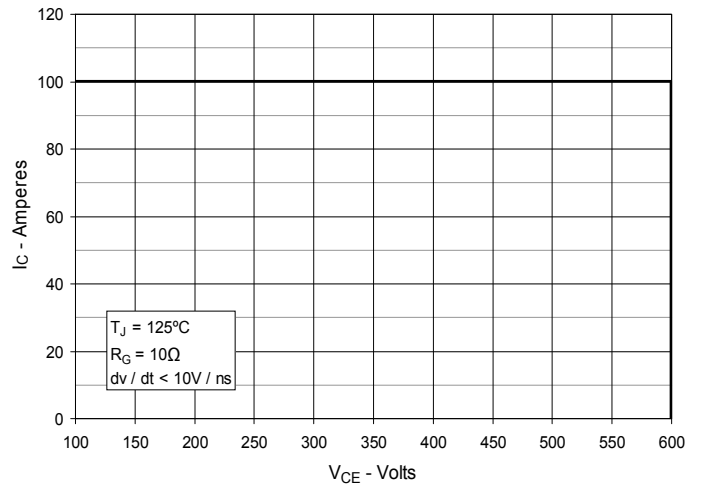
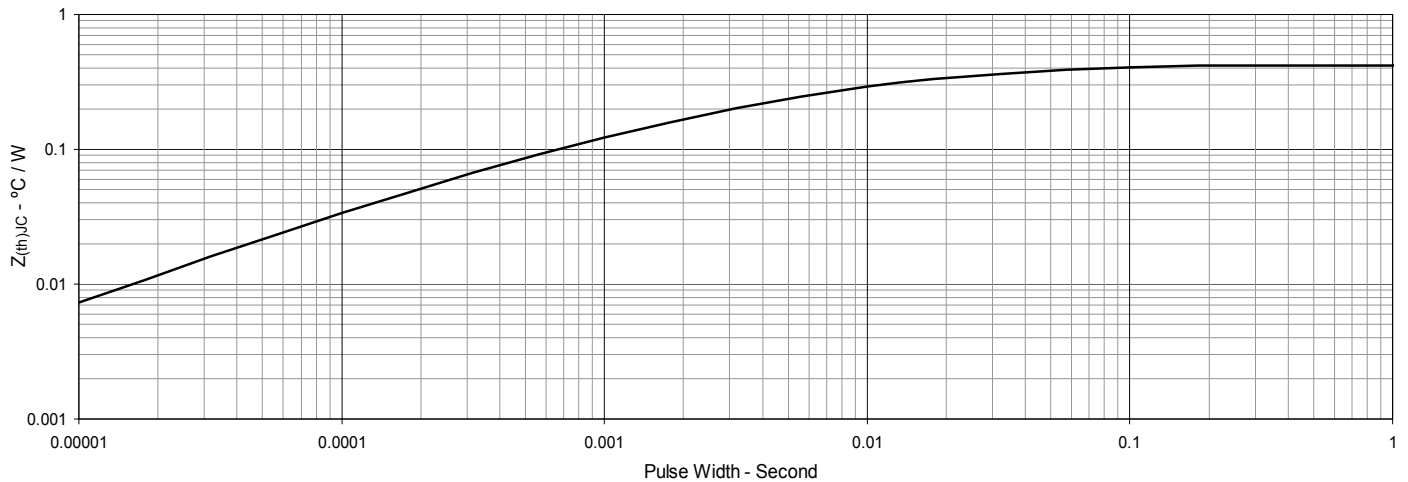
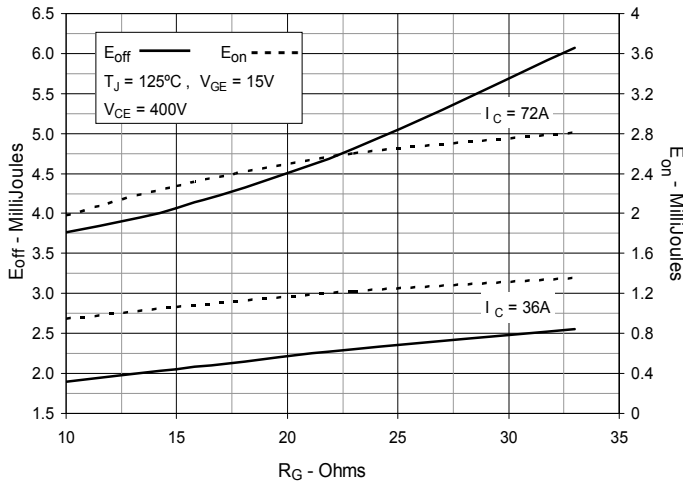

Fig. 11. Maximum Transient Thermal Impedance



**Fig. 12. Inductive Switching Energy Loss vs. Gate Resistance**



**Fig. 13. Inductive Switching Energy Loss vs. Collector Current**

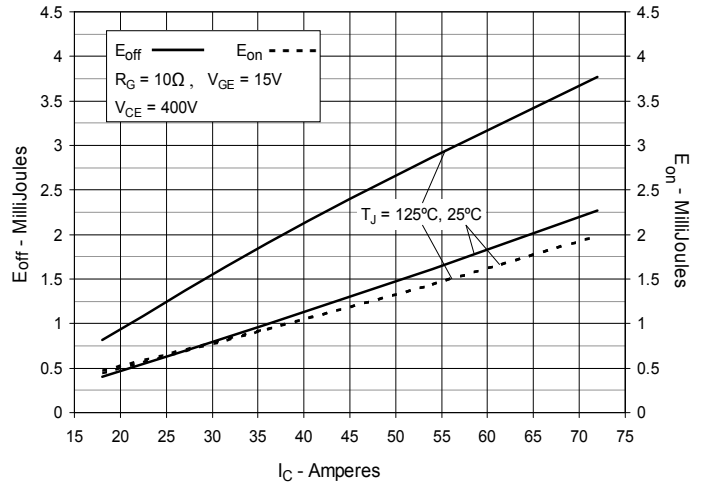

**Fig. 14. Inductive Switching Energy Loss vs. Junction Temperature**

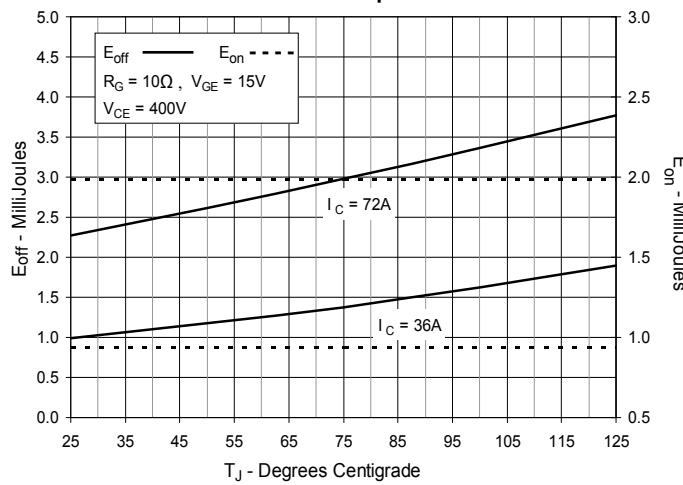

**Fig. 15. Inductive Turn-off Switching Times vs. Gate Resistance**

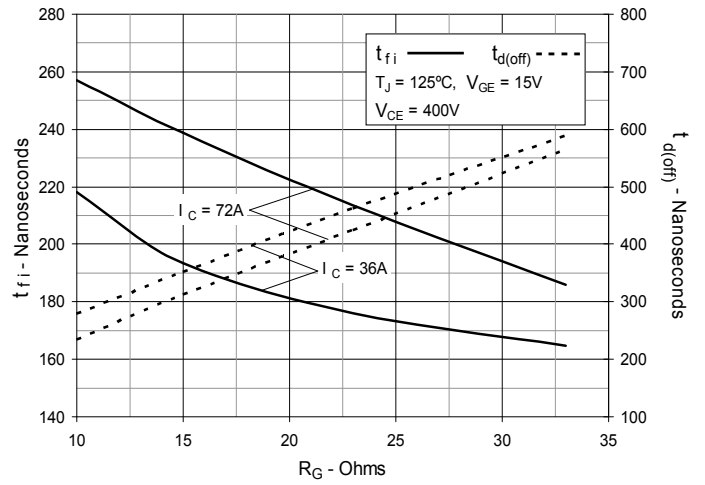

**Fig. 16. Inductive Turn-off Switching Times vs. Collector Current**

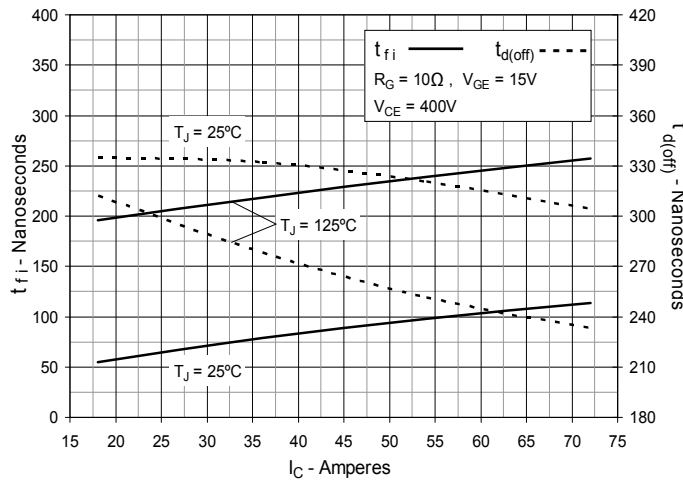

**Fig. 17. Inductive Turn-off Switching Times vs. Junction Temperature**

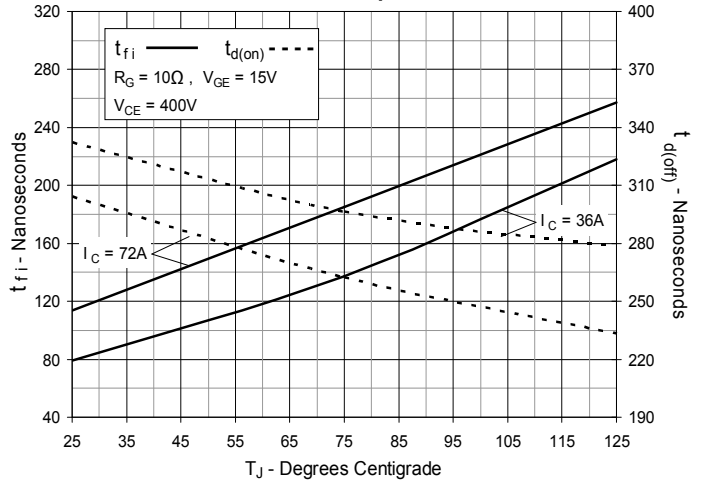

**Fig. 18. Inductive Turn-on Switching Times vs. Gate Resistance**

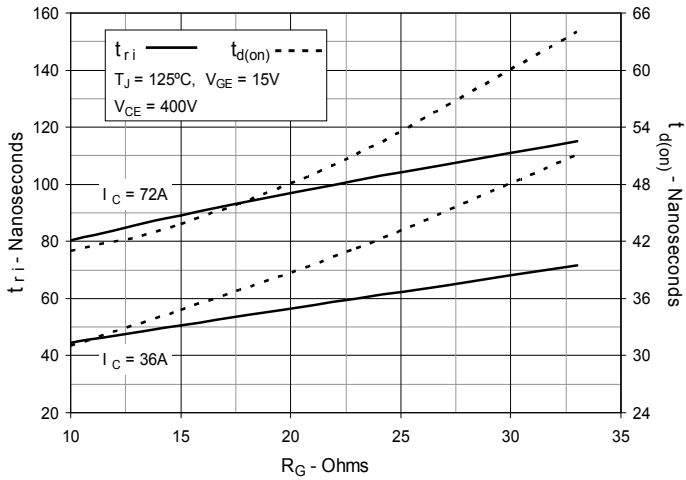

**Fig. 19. Inductive Turn-on Switching Times vs. Collector Current**

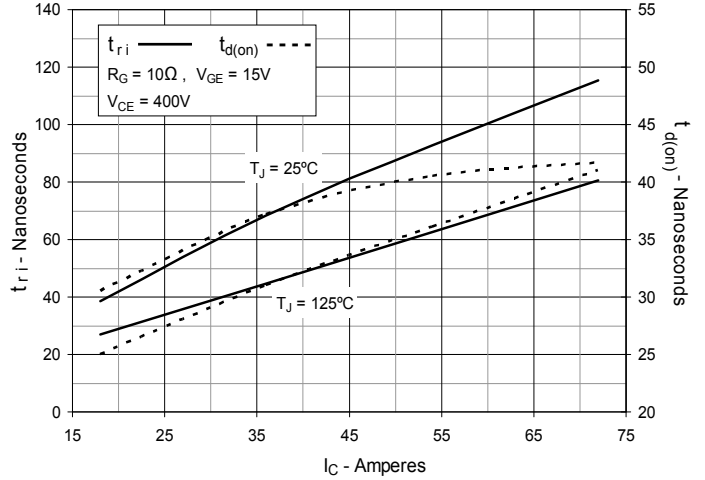

**Fig. 20. Inductive Turn-on Switching Times vs. Junction Temperature**

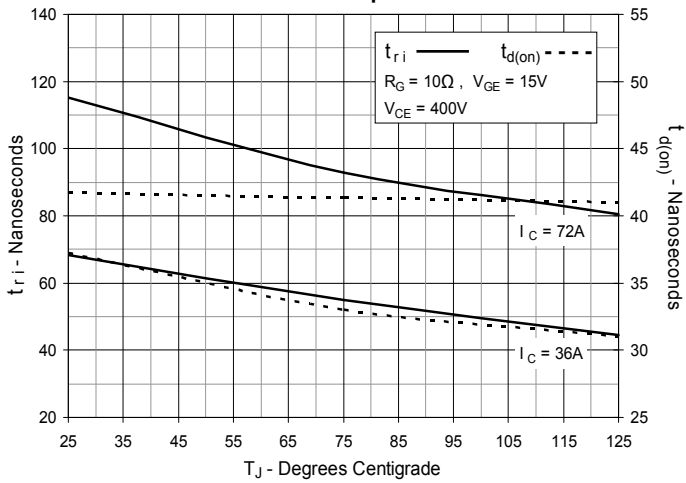

**Fig. 21. Forward Voltage vs. Forward Current**

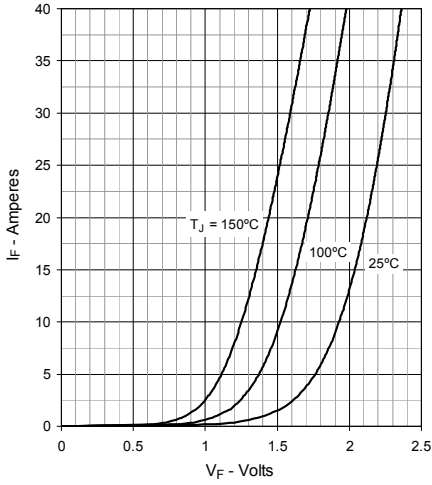

**Fig. 22. Reverse Recovery Charge vs.  $-di_F/dt$**

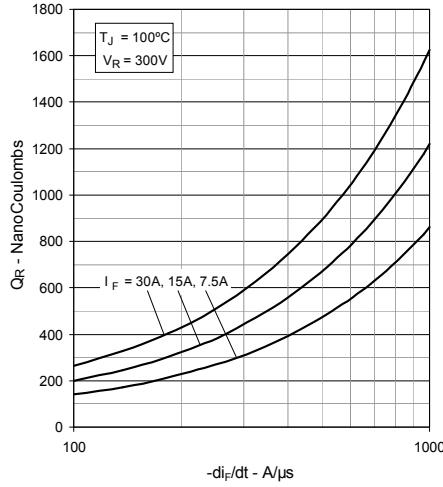

**Fig. 23. Peak Reverse Current vs.  $-di_F/dt$**

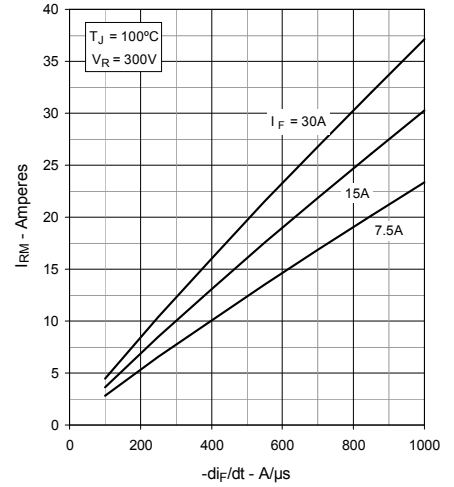

**Fig. 24. Dynamic Parameter vs. Junction Temperature**

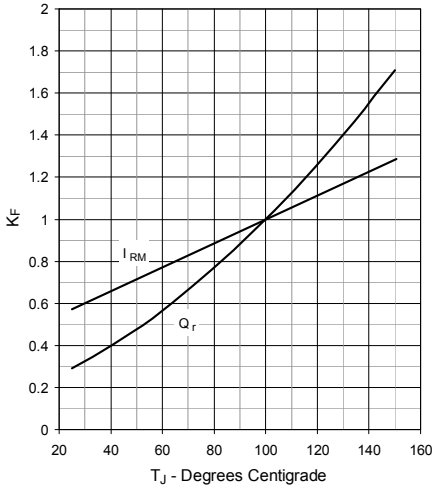

**Fig. 25. Reverse Recovery Time vs.  $-di_F/dt$**

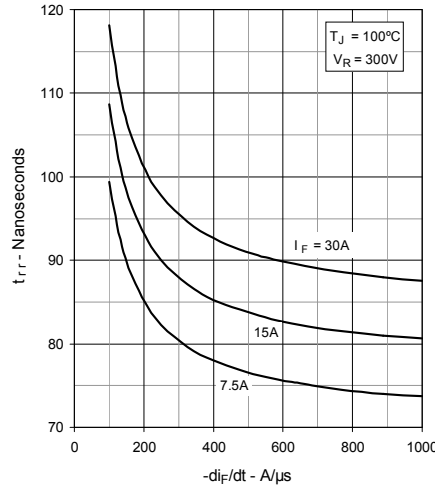

**Fig. 26. Peak Forward Voltage & Forward Recovery Time vs.  $di_F/dt$**

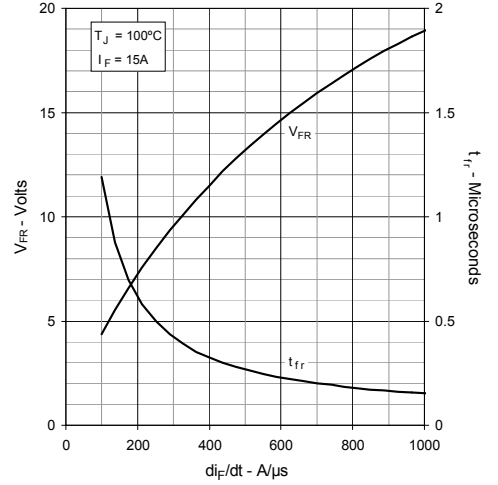

**Fig. 27. Maximum Transient Thermal Impedance (for Diode)**

