

# HiPerFAST™ IGBT

IXGH 32N60B  
IXGT 32N60B  
IXGH 32N60BD1  
IXGT 32N60BD1

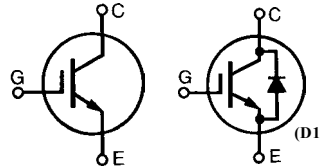

$V_{CES} = 600 \text{ V}$   
 $I_{C25} = 60 \text{ A}$   
 $V_{CE(sat)} = 2.3 \text{ V}$   
 $t_{fi(typ)} = 85 \text{ ns}$

Symbol	Test Conditions	Maximum Ratings
$V_{CES}$	$T_J = 25^\circ\text{C to } 150^\circ\text{C}$	600 V
$V_{CGR}$	$T_J = 25^\circ\text{C to } 150^\circ\text{C}; R_{GE} = 1 \text{ M}\Omega$	600 V
$V_{GES}$	Continuous	$\pm 20 \text{ V}$
$V_{GEM}$	Transient	$\pm 30 \text{ V}$
$I_{C25}$	$T_C = 25^\circ\text{C}$	60 A
$I_{C90}$	$T_C = 90^\circ\text{C}$	32 A
$I_{CM}$	$T_C = 25^\circ\text{C}, 1 \text{ ms}$	120 A
<b>SSOA (RBSOA)</b>	$V_{GE} = 15 \text{ V}, T_{VJ} = 125^\circ\text{C}, R_G = 22 \Omega$ Clamped inductive load	$I_{CM} = 64$ @ $0.8 V_{CES}$ A
$P_C$	$T_C = 25^\circ\text{C}$	200 W
$T_J$		-55 ... +150 °C
$T_{JM}$		150 °C
$T_{stg}$		-55 ... +150 °C
$M_d$	Mounting torque (M3) TO-247AD	1.13/10 Nm/lb.in.
Maximum lead temperature for soldering 1.6 mm (0.062 in.) from case for 10 s		300 °C
<b>Weight</b>	TO-247AD	6 g
	TO-268	4 g

TO-268 (IXGT)

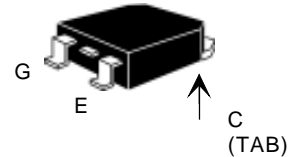

TO-247 AD (IXGH)

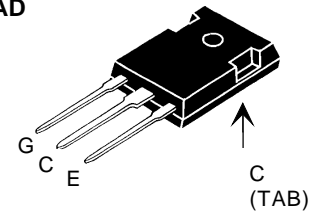

G = Gate, E = Emitter, C = Collector, TAB = Collector

## Features

- International standard packages
- High frequency IGBT and antiparallel FRED in one package
- High current handling capability
- HiPerFAST™ HDMOS™ process
- MOS Gate turn-on -drive simplicity

## Applications

- Uninterruptible power supplies (UPS)
- Switched-mode and resonant-mode power supplies
- AC motor speed control
- DC servo and robot drives
- DC choppers

## Advantages

- Space savings (two devices in one package)
- High power density
- Suitable for surface mounting
- Very low switching losses for high frequency applications
- Easy to mount with 1 screw, TO-247 (insulated mounting screw hole)

Symbol	Test Conditions	Characteristic Values ( $T_J = 25^\circ\text{C}$ , unless otherwise specified)		
		min.	typ.	max.
$BV_{CES}$	$I_C = 250 \mu\text{A}, V_{GE} = 0 \text{ V}$	600		V
$V_{GE(th)}$	$I_C = 250 \mu\text{A}, V_{CE} = V_{GE}$	2.5		5.0 V
$I_{CES}$	$V_{CE} = 0.8 \cdot V_{CES}$ $V_{GE} = 0 \text{ V}$	$T_J = 25^\circ\text{C}$ $T_J = 150^\circ\text{C}$		200 $\mu\text{A}$ 1 mA 3 mA
$I_{GES}$	$V_{CE} = 0 \text{ V}, V_{GE} = \pm 20 \text{ V}$			$\pm 100 \text{ nA}$
$V_{CE(sat)}$	$I_C = I_{C90}, V_{GE} = 15 \text{ V}$			2.3 V

Symbol	Test Conditions	Characteristic Values ( $T_J = 25^\circ\text{C}$ , unless otherwise specified)		
		min.	typ.	max.
$g_{fs}$	$I_C = I_{C90}$ ; $V_{CE} = 10\text{ V}$ , Pulse test, $t \leq 300\ \mu\text{s}$ , duty cycle $\leq 2\%$	15	25	S
$C_{ies}$	$V_{CE} = 25\text{ V}$ , $V_{GE} = 0\text{ V}$ , $f = 1\text{ MHz}$		2700	pF
$C_{oes}$			32N60B: 210 32N60BD1: 240	pF
$C_{res}$			50	pF
$Q_G$	$I_C = I_{C90}$ , $V_{GE} = 15\text{ V}$ , $V_{CE} = 0.5 V_{CES}$		110	150
$Q_{GE}$			23	35
$Q_{GC}$			40	75
$t_{d(on)}$	<b>Inductive load, <math>T_J = 25^\circ\text{C}</math></b> $I_C = I_{C90}$ , $V_{GE} = 15\text{ V}$ $V_{CE} = 0.8 V_{CES}$ , $R_G = R_{off} = 4.7\ \Omega$ Remarks: Switching times may increase for $V_{CE}(\text{Clamp}) > 0.8 \cdot V_{CES}$ , higher $T_J$ or increased $R_G$		25	ns
$t_{ri}$			20	ns
$t_{d(off)}$			100	200
$t_{fi}$			80	150
$E_{off}$			0.6	1.2
$t_{d(on)}$	<b>Inductive load, <math>T_J = 125^\circ\text{C}</math></b> $I_C = I_{C90}$ , $V_{GE} = 15\text{ V}$ $V_{CE} = 0.8 V_{CES}$ , $R_G = R_{off} = 4.7\ \Omega$ Remarks: Switching times may increase for $V_{CE}(\text{Clamp}) > 0.8 \cdot V_{CES}$ , higher $T_J$ or increased $R_G$		25	ns
$t_{ri}$			25	ns
$E_{on}$			32N60B: 0.3 32N60BD1: 1.0	mJ
$t_{d(off)}$			120	ns
$t_{fi}$			120	ns
$E_{off}$		1.2	mJ	
$R_{thJC}$	TO-247			0.62
$R_{thCK}$			0.25	K/W

Symbol	Test Conditions	Characteristic Values ( $T_J = 25^\circ\text{C}$ , unless otherwise specified)		
		min.	typ.	max.
$V_F$	$I_F = I_{C90}$ , $V_{GE} = 0\text{ V}$ , Pulse test, $t \leq 300\ \mu\text{s}$ , duty cycle $d \leq 2\%$		$T_J = 150^\circ\text{C}$ : 1.6 $T_J = 25^\circ\text{C}$ : 2.5	V
$I_{RM}$	$I_F = I_{C90}$ , $V_{GE} = 0\text{ V}$ , $-di_F/dt = 100\text{ A}/\mu\text{s}$ $V_R = 360\text{ V}$ $I_F = 1\text{ A}$ ; $-di_F/dt = 100\text{ A}/\mu\text{s}$ ; $V_R = 30\text{ V}$		6	A
$t_{rr}$			$T_J = 125^\circ\text{C}$ : 100 $T_J = 25^\circ\text{C}$ : 25	ns
$R_{thJC}$				1.0

### TO-247 AD (IXGH) Outline

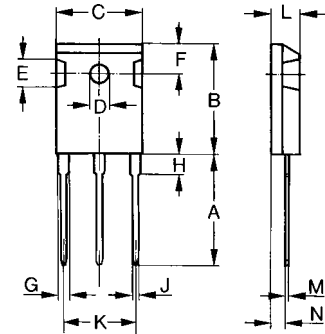

Dim.	Millimeter		Inches	
	Min.	Max.	Min.	Max.
A	19.81	20.32	0.780	0.800
B	20.80	21.46	0.819	0.845
C	15.75	16.26	0.610	0.640
D	3.55	3.65	0.140	0.144
E	4.32	5.49	0.170	0.216
F	5.4	6.2	0.212	0.244
G	1.65	2.13	0.065	0.084
H	-	4.5	-	0.177
J	1.0	1.4	0.040	0.055
K	10.8	11.0	0.426	0.433
L	4.7	5.3	0.185	0.209
M	0.4	0.8	0.016	0.031
N	1.5	2.49	0.087	0.102

### TO-268AA (D<sup>3</sup> PAK)

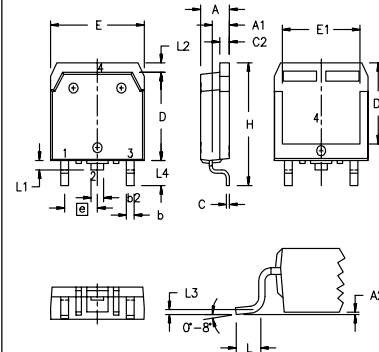

Dim.	Millimeter		Inches	
	Min.	Max.	Min.	Max.
A	4.9	5.1	.193	.201
A <sub>1</sub>	2.7	2.9	.106	.114
A <sub>2</sub>	.02	.25	.001	.010
b	1.15	1.45	.045	.057
b <sub>2</sub>	1.9	2.1	.075	.083
C	.4	.65	.016	.026
D	13.80	14.00	.543	.551
E	15.85	16.05	.624	.632
E <sub>1</sub>	13.3	13.6	.524	.535
e	5.45 BSC		.215 BSC	
H	18.70	19.10	.736	.752
L	2.40	2.70	.094	.106
L <sub>1</sub>	1.20	1.40	.047	.055
L <sub>2</sub>	1.00	1.15	.039	.045
L <sub>3</sub>	0.25 BSC		.010 BSC	
L <sub>4</sub>	3.80	4.10	.150	.161

IXYS reserves the right to change limits, test conditions, and dimensions.

IXYS MOSFETS and IGBTs are covered by one or more of the following U.S. patents: 4,835,592 4,881,106 5,017,508 5,049,961 5,187,117 5,486,715 6,306,728B1  
4,850,072 4,931,844 5,034,796 5,063,307 5,237,481 5,381,025

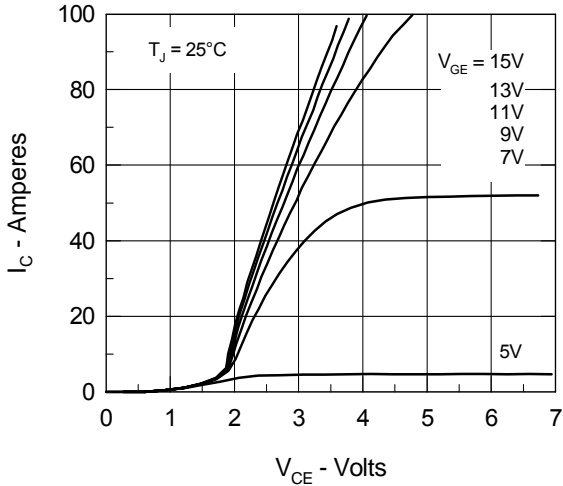

Fig. 1. Saturation Voltage Characteristics

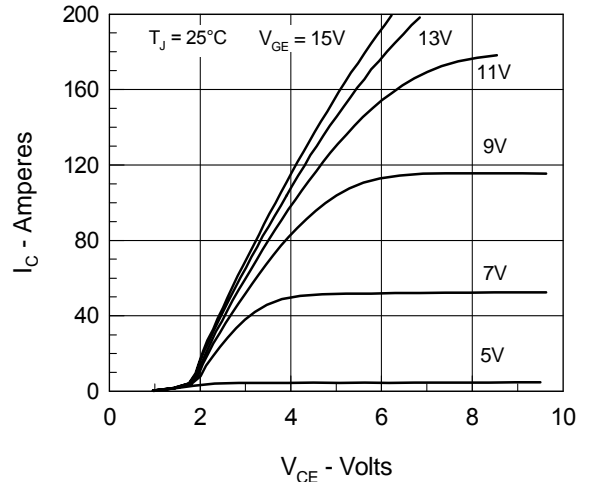

Fig. 2. Extended Output Characteristics

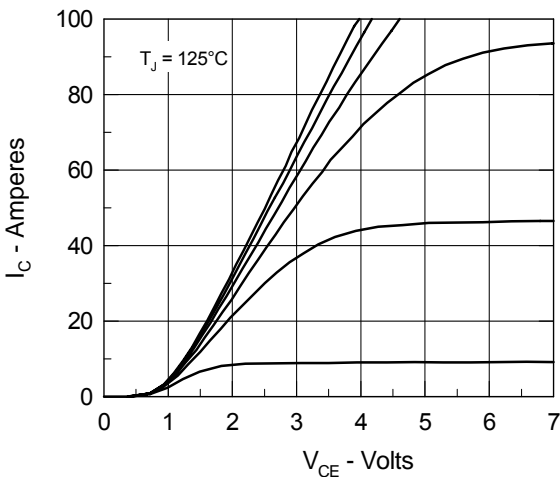

Fig. 3. Saturation Voltage Characteristics

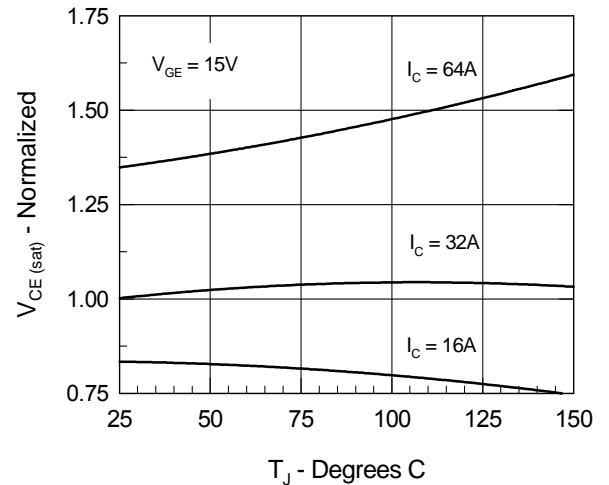
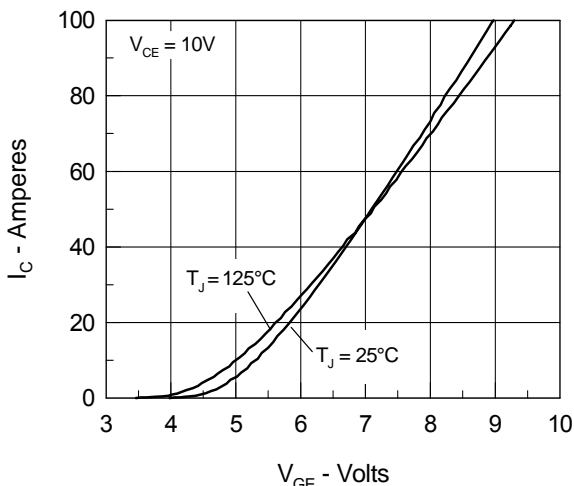
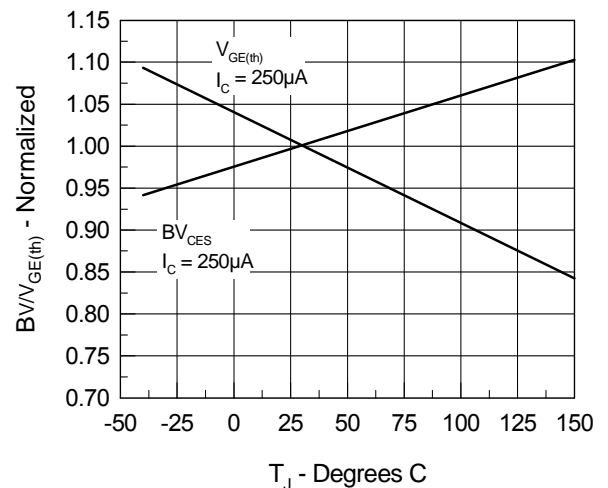

 Fig. 4. Temperature Dependence of  $V_{CE(sat)}$ 

Fig. 5. Admittance Curves

 Fig. 6. Temperature Dependence of  $BV_{DSS}$  &  $V_{GE(th)}$

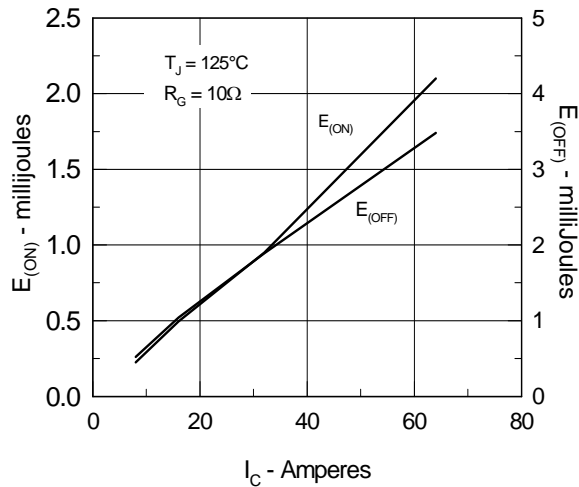

Fig. 7. Dependence of  $t_{fi}$  and  $E_{OFF}$  on  $I_C$ .

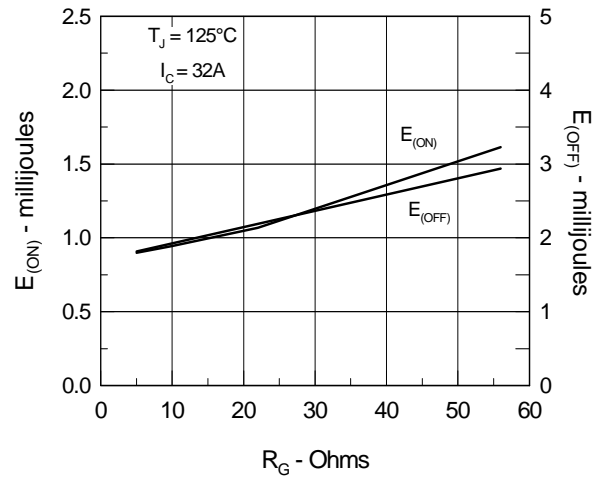

Fig. 8. Dependence of  $t_{fi}$  and  $E_{OFF}$  on  $R_G$ .

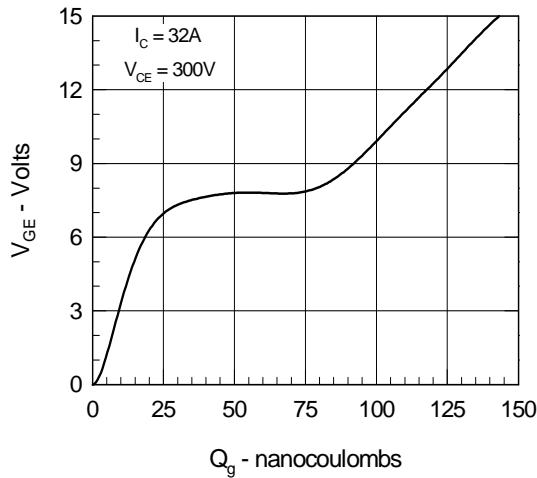

Fig. 9. Gate Charge

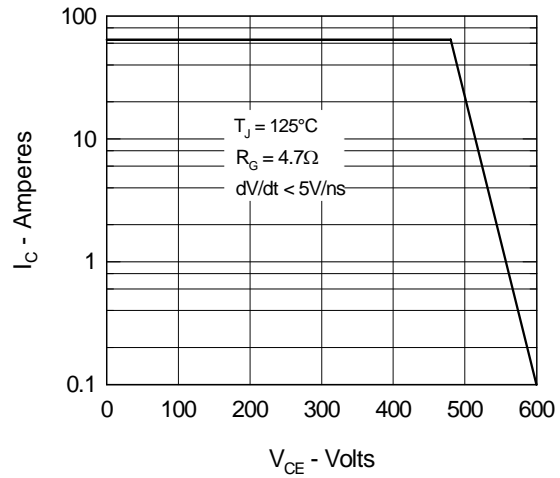

Fig. 10. Turn-off Safe Operating Area

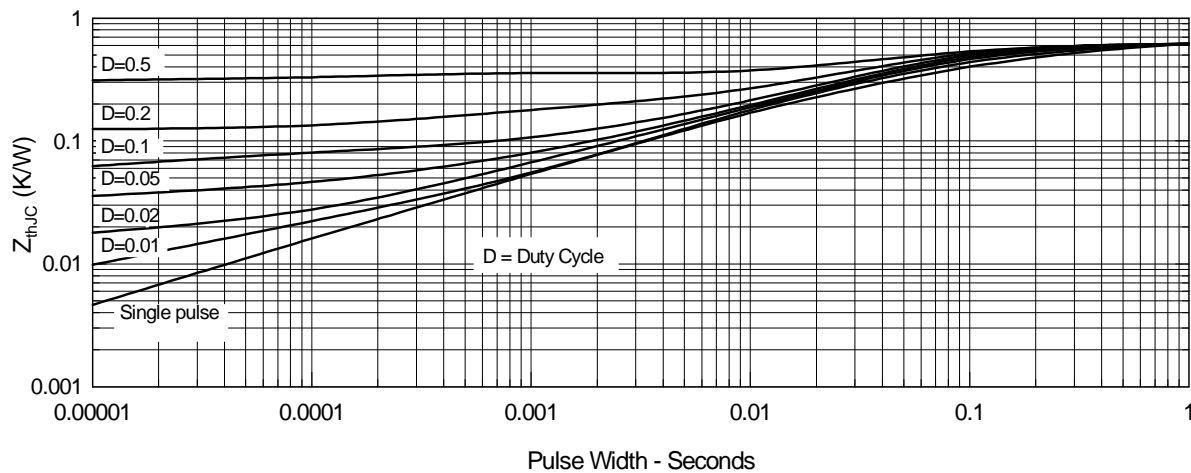

Fig. 11. Transient Thermal Resistance

IXYS reserves the right to change limits, test conditions, and dimensions.

IXYS MOSFETS and IGBTs are covered by one or more of the following U.S. patents:

4,835,592	4,881,106	5,017,508	5,049,961	5,187,117	5,486,715	6,306,728B1
4,850,072	4,931,844	5,034,796	5,063,307	5,237,481	5,381,025	

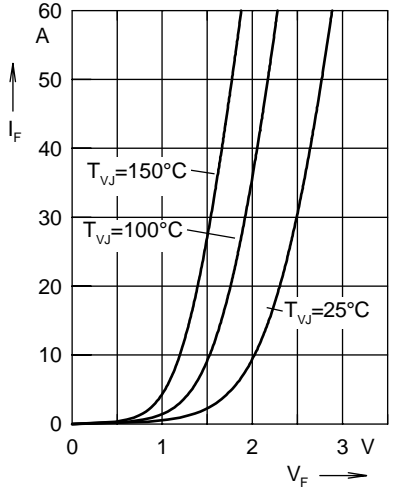

Fig. 12 Forward current  $I_F$  versus  $V_F$

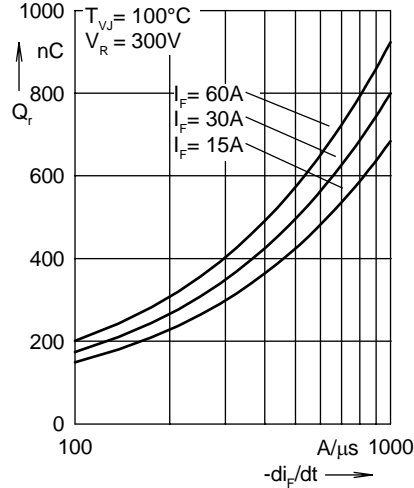

Fig. 13 Reverse recovery charge  $Q_r$  versus  $-di_F/dt$

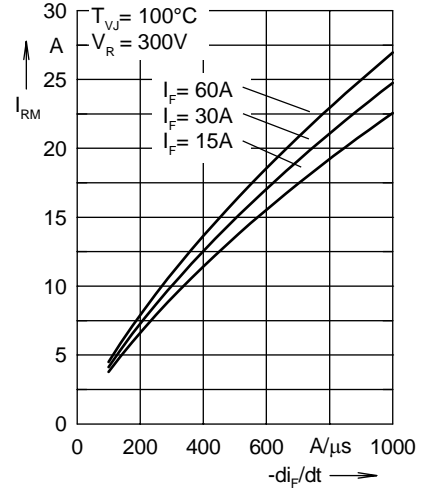

Fig. 14 Peak reverse current  $I_{RM}$  versus  $-di_F/dt$

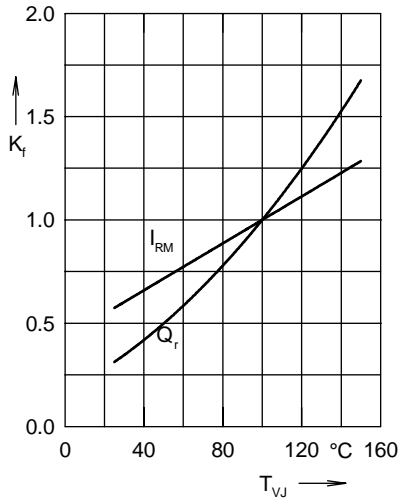

Fig. 15 Dynamic parameters  $Q_r$ ,  $I_{RM}$  versus  $T_{VJ}$

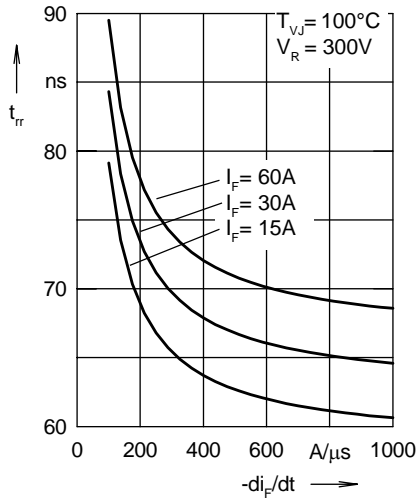

Fig. 16 Recovery time  $t_{rr}$  versus  $-di_F/dt$

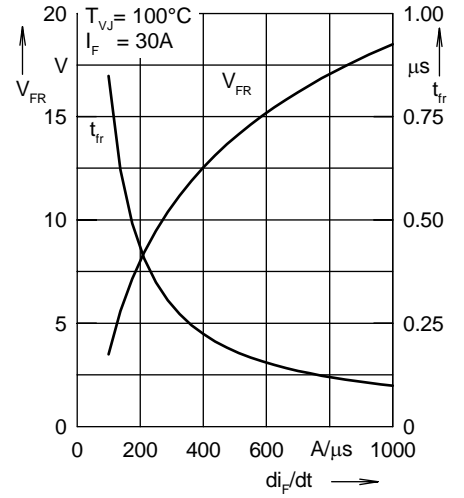

Fig. 17 Peak forward voltage  $V_{FR}$  and  $t_{tr}$  versus  $di_F/dt$

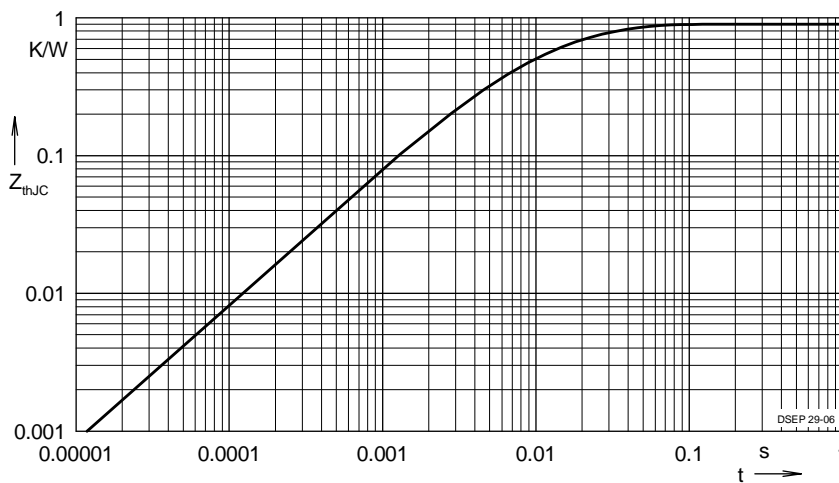

Fig. 18 Transient thermal resistance junction to case

Constants for  $Z_{thJC}$  calculation:

i	$R_{thi}$ (K/W)	$t_i$ (s)
1	0.502	0.0052
2	0.193	0.0003
3	0.205	0.0162