

XPT IGBT

Copack

$I_{C25} = 43 \text{ A}$
 $V_{CES} = 1200 \text{ V}$
 $V_{CE(sat)typ} = 1.8 \text{ V}$

Part number
IXA27IF1200HJ

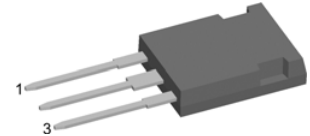
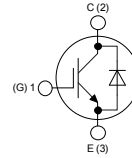

Features / Advantages:

- Easy paralleling due to the positive temperature coefficient of the on-state voltage
- Rugged XPT design (Xtreme light Punch Through) results in:
 - short circuit rated for 10 μsec .
 - very low gate charge
 - low EMI
 - square RBSOA @ 3x I_C
- Thin wafer technology combined with the XPT design results in a competitive low $V_{CE(sat)}$
- SONIC™ diode
 - fast and soft reverse recovery
 - low operating forward voltage

Applications:

- AC motor drives
- Solar inverter
- Medical equipment
- Uninterruptible power supply
- Air-conditioning systems
- Welding equipment
- Switched-mode and resonant-mode power supplies
- Inductive heating, cookers

Package:

- Housing: ISOPLUS247
- Industry standard outline
- DCB isolated backside
- Isolation Voltage 3000 V
- Epoxy meets UL 94V-0
- RoHS compliant

IGBT

Symbol	Definition	Conditions	Ratings			Unit
			min.	typ.	max.	
V_{CES}	Collector emitter voltage	$V_{GE} = 0 \text{ V}$			1200	V
V_{GES}	Maximum DC gate voltage				± 20	V
I_{C25}	Collector current				43	A
I_{C90}					27	A
P_{tot}	Total power dissipation				150	W
I_{CES}	Collector emitter leakage current	$V_{CE} = V_{CES} ; V_{GE} = 0 \text{ V}$			0.1	mA
				0.1		mA
I_{GES}	Gate emitter leakage current	$V_{CE} = 0 \text{ V}; V_{GE} = \pm 20 \text{ V}$			500	nA
$V_{CE(sat)}$	Collector emitter saturation voltage	$I_C = 25 \text{ A}; V_{GE} = 15 \text{ V}$		1.8	2.1	V
				2.1		V
$V_{GE(th)}$	Gate emitter threshold voltage	$I_C = 1 \text{ mA}; V_{GE} = V_{CE}$	5.4	6	6.5	V
Q_{Gon}	Total gate charge	$V_{CE} = 600 \text{ V}; V_{GE} = 15 \text{ V}; I_C = 25 \text{ A}$		76		nC
$t_{d(on)}$	Turn-on delay time			70		ns
t_r	Current rise time			40		ns
$t_{d(off)}$	Turn-off delay time	Inductive load		250		ns
t_f	Current fall time	$V_{CE} = 600 \text{ V}; I_C = 25 \text{ A}$		100		ns
E_{on}	Turn-on energy per pulse	$V_{GE} = \pm 15 \text{ V}; R_G = 39 \Omega$	$T_{VJ} = 125^\circ\text{C}$	2.5		mJ
E_{off}	Turn-off energy per pulse			3.0		mJ
RBSOA	Reverse bias safe operation area	$V_{GE} = 15 \text{ V}; R_G = 39 \Omega$ $V_{CEK} = 1200 \text{ V}$	$T_{VJ} = 125^\circ\text{C}$		75	A
SCSOA	Short circuit safe operation area					
t_{sc}	Short circuit duration	$V_{CE} = 900 \text{ V}; V_{GE} = \pm 15 \text{ V}$	$T_{VJ} = 125^\circ\text{C}$		10	μs
I_{sc}	Short circuit current	$R_G = 39 \Omega$; non-repetitive			100	A
R_{thJC}	Thermal resistance junction to case				0.84	K/W

Diode

Symbol	Definition	Conditions	Ratings			Unit	
			min.	typ.	max.		
I_{F25}	Forward current	$T_C = 25^\circ\text{C}$			42	A	
I_{F90}		$T_C = 90^\circ\text{C}$			25	A	
V_F	Forward voltage	$I_F = 30\text{ A}$		$T_{VJ} = 25^\circ\text{C}$	1.95	2.2	V
				$T_{VJ} = 125^\circ\text{C}$	1.95		V
Q_{rr}	Reverse recovery charge	$V_R = 600\text{ V}$		$T_{VJ} = 125^\circ\text{C}$	3.5		μC
I_{RM}	Maximum reverse recovery current				30		A
t_{rr}	Reverse recovery time	$I_F = 30\text{ A}$		$T_{VJ} = 125^\circ\text{C}$	350		ns
$E_{rec(off)}$	Reverse recovery losses at turn-off				0.9		mJ
R_{thJC}	Thermal resistance junction to case				1.2		K/W

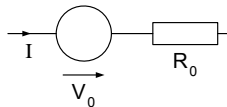
Equivalent Circuits for Simulation

Symbol	Definition		Ratings			Unit
			min.	typ.	max.	
V_0	IGBT	$T_{VJ} = 150^\circ\text{C}$			1.1	V
R_0			55		$\text{m}\Omega$	
V_0	Diode	$T_{VJ} = 150^\circ\text{C}$			1.25	V
R_0			28.3		$\text{m}\Omega$	

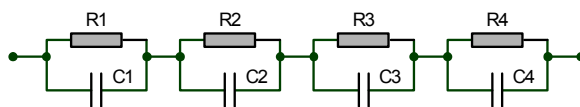

$$Z_{th}(t) = \sum_{i=1}^n \left[R_i \cdot \left(1 - \exp\left(-\frac{t}{\tau_i}\right) \right) \right]$$

$$\tau_i = R_i \cdot C_i$$

	IGBT	Diode
R_1	0.18	0.3413
R_2	0.14	0.2171
R_3	0.36	0.3475
R_4	0.16	0.2941
τ_1	0.0025	0.0025
τ_2	0.03	0.03
τ_3	0.03	0.03
τ_4	0.08	0.08

Package ISOPLUS247

Symbol	Definition	Conditions	Ratings			Unit
			min.	typ.	max.	
T_{VJ}	Virtual junction temperature		-55		150	°C
T_{stg}	Storage temperature		-55		150	°C
R_{thCH}	Thermal resistance case to heatsink			0.25		K/W
Weight				6		g
F_C	Mounting force with clip		20		120	N
V_{ISOL}	Isolation voltage	t = 1 second	3600			V
		t = 1 minute	3000			V
d_s	Creepage distance on surface					mm
d_A	Striking distance through air					mm

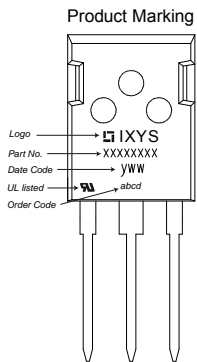
Part number

I = IGBT
 X = XPT IGBT
 A = Gen 1 / std
 27 = Current Rating [A]
 IF = Copack
 1200 = Reverse Voltage [V]
 HJ = ISOPLUS247 (3)

Ordering	Part Name	Marking on Product	Delivering Mode	Base Qty	Code Key
Standard	IXA 27 IF 1200 HJ	IXA27IF1200HJ			

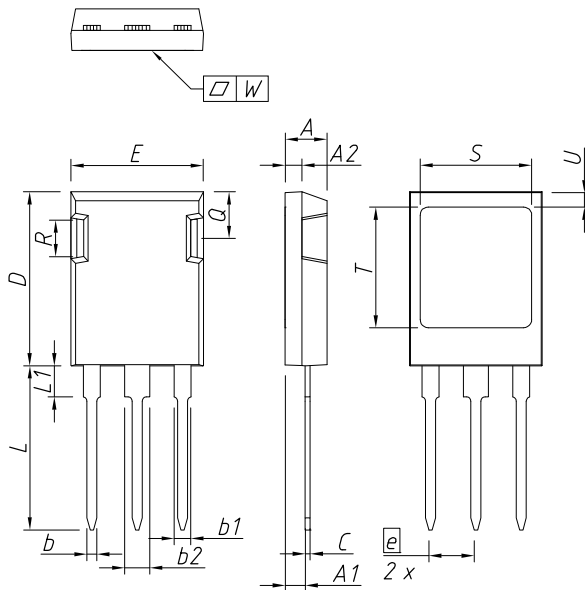

DIM.	MILLIMETER		INCHES	
	MIN	MAX	MIN	MAX
A	4,83	5,21	0,190	0,205
A1	2,29	2,54	0,090	0,100
A2	1,91	2,16	0,075	0,085
b	1,14	1,40	0,045	0,055
b1	1,91	2,15	0,075	0,085
b2	2,92	3,20	0,115	0,126
C	0,61	0,83	0,024	0,033
D	20,80	21,34	0,819	0,840
E	15,75	16,13	0,620	0,635
e	5,45 BSC		0,215 BSC	
L	19,81	20,60	0,780	0,811
L1	3,81	4,38	0,150	0,172
Q	5,59	6,20	0,220	0,244
R	4,32	4,85	0,170	0,191
S	13,21	13,72	0,520	0,540
T	15,75	16,26	0,620	0,640
U	1,65	2,03	0,065	0,080
W	-	0,10	-	0,004

Die konvexe Form des Substrates ist typ. < 0.04 mm über der Kunststoffoberfläche der Bauteilunterseite
 The convex bow of substrate is typ. < 0.04 mm over plastic surface level of device bottom side

Die Gehäuseabmessungen entsprechen dem Typ TO-247 AD gemäß JEDEC außer Schraubloch und L_{max} .
 This drawing will meet all dimensions requirement of JEDEC outline TO-247 AD except screw hole and except L_{max} .

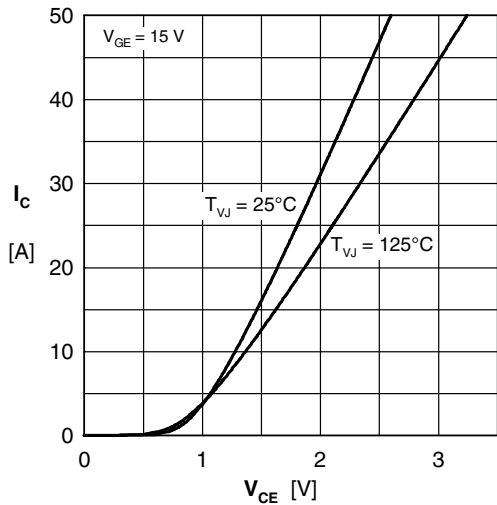

Fig. 1 Typ. output characteristics

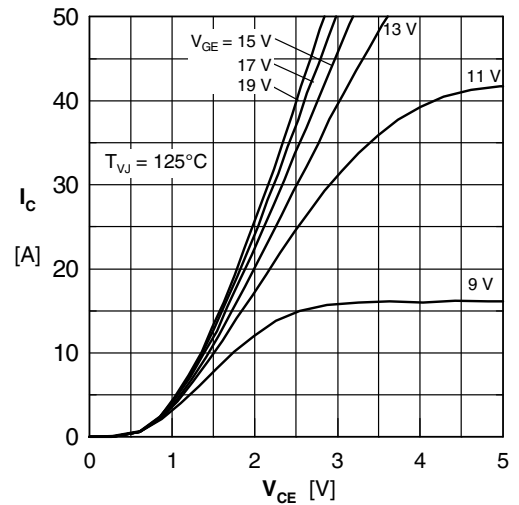

Fig. 2 Typ. output characteristics

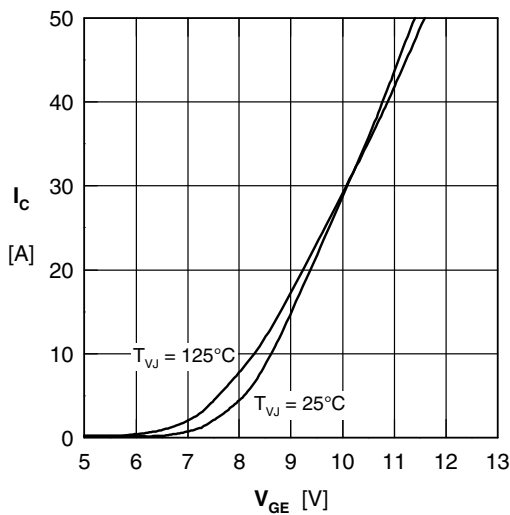

Fig. 3 Typ. transfer characteristics

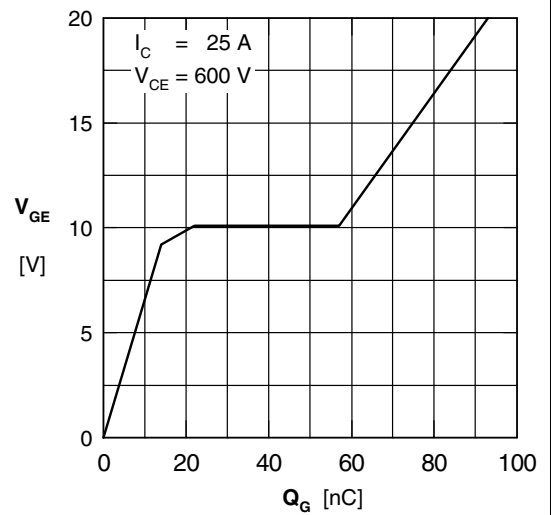

Fig. 4 Typ. turn-on gate charge

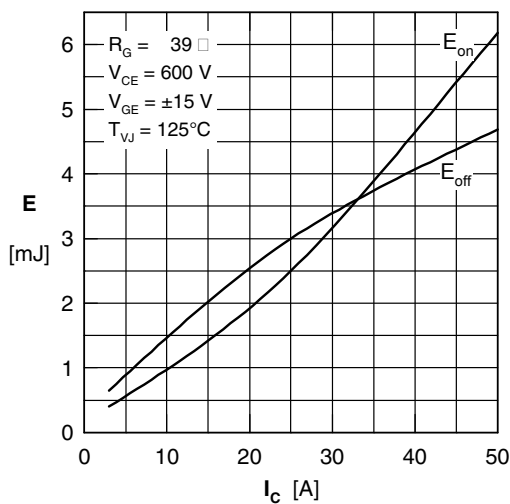

Fig. 5 Typ. switching energy vs. collector current

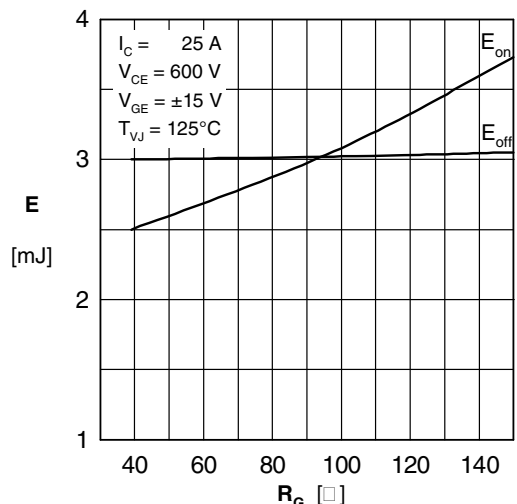

Fig. 6 Typ. switching energy vs. gate resistance

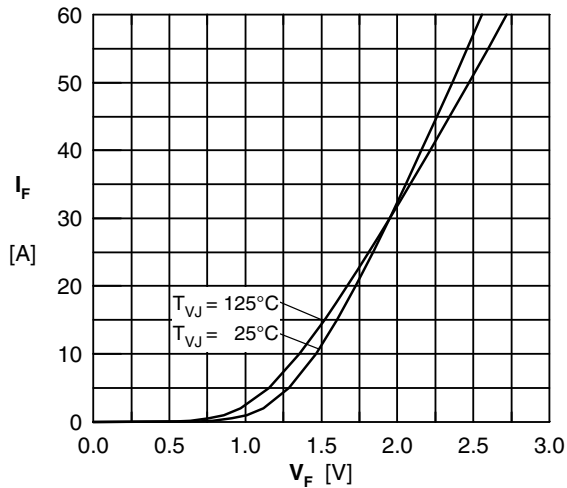

Fig. 7 Typ. Forward current versus V_F

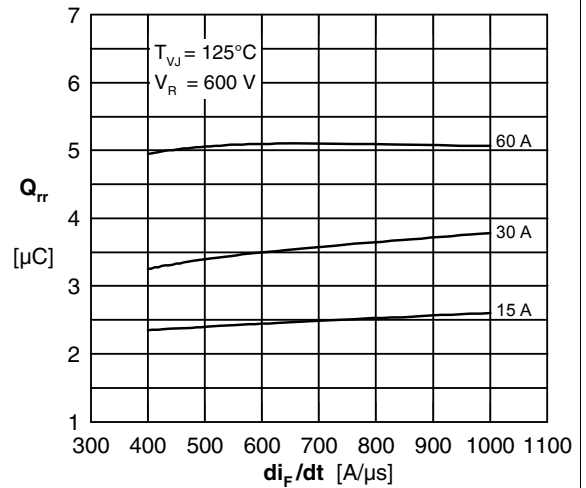

Fig. 8 Typ. reverse recov.charge Q_{rr} vs. di/dt

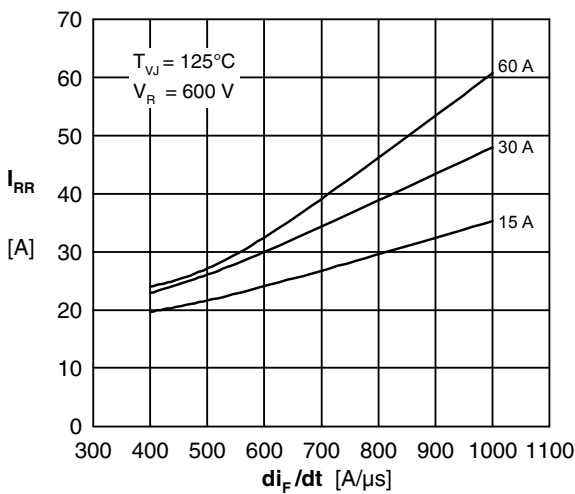

Fig. 9 Typ. peak reverse current I_{RM} vs. di/dt

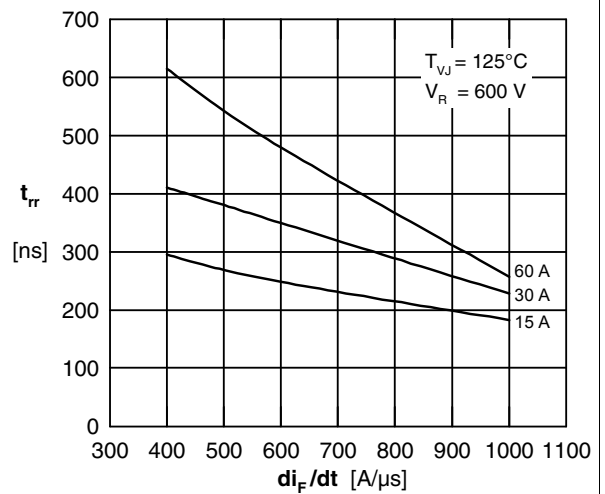

Fig. 10 Typ. recovery time t_{rr} versus di/dt

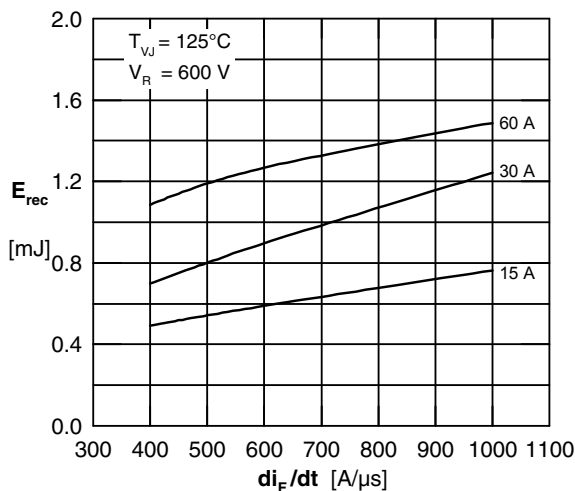

Fig. 11 Typ. recovery energy E_{rec} versus di/dt

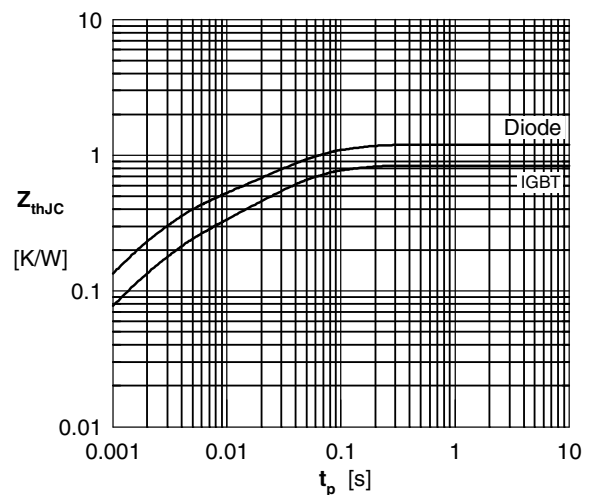

Fig. 12 Typ. transient thermal impedance