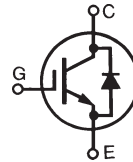

**XPT™ 600V
GenX3™ w/ Diode**
IXXR100N60B3H1

(Electrically Isolated Tab)

 Extreme Light Punch Through
IGBT for 10-30kHz Switching

$$V_{CES} = 600V$$

$$I_{C110} = 68A$$

$$V_{CE(sat)} \leq 1.80V$$

$$t_{fi(typ)} = 150ns$$

Symbol	Test Conditions	Maximum Ratings	
V_{CES}	$T_J = 25^\circ C$ to $150^\circ C$	600	V
V_{CGR}	$T_J = 25^\circ C$ to $150^\circ C$, $R_{GE} = 1M\Omega$	600	V
V_{GES}	Continuous	± 20	V
V_{GEM}	Transient	± 30	V
I_{C25}	$T_C = 25^\circ C$	145	A
I_{C110}	$T_C = 110^\circ C$	68	A
I_{F90}	$T_C = 90^\circ C$	54	A
I_{CM}	$T_C = 25^\circ C$, 1ms	440	A
I_A	$T_C = 25^\circ C$	50	A
E_{AS}	$T_C = 25^\circ C$	600	mJ
SSOA (RBSOA)	$V_{GE} = 15V$, $T_{VJ} = 150^\circ C$, $R_G = 2\Omega$ Clamped Inductive Load	$I_{CM} = 200$ @ $V_{CE} \leq V_{CES}$	A
t_{sc} (SCSOA)	$V_{GE} = 15V$, $V_{CE} = 360V$, $T_J = 150^\circ C$ $R_G = 10\Omega$, Non Repetitive	10	μs
P_C	$T_C = 25^\circ C$	400	W
T_J		-55 ... +150	$^\circ C$
T_{JM}		150	$^\circ C$
T_{stg}		-55 ... +150	$^\circ C$
T_L	1.6mm (0.062 in.) from Case for 10s	300	$^\circ C$
T_{SOLD}	Plastic Body for 10s	260	$^\circ C$
V_{ISOL}	50/60 Hz, 1 Minute	2500	V~
F_C	Mounting Force	20..120/4.5..27	N/lb.
Weight		5	g

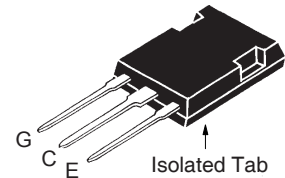
ISOPLUS247™

G = Gate C = Collector
E = Emitter

Features

- Silicon Chip on Direct-Copper Bond (DCB) Substrate
- Isolated Mounting Surface
- 2500V~ Electrical Isolation
- Optimized for 10-30kHz Switching
- Square RBSOA
- Avalanche Rated
- Short Circuit Capability
- Anti-Parallel Ultra Fast Diode
- High Current Handling Capability

Advantages

- High Power Density
- Low Gate Drive Requirement

Applications

- Power Inverters
- UPS
- Motor Drives
- SMPS
- PFC Circuits
- Battery Chargers
- Welding Machines

Symbol	Test Conditions ($T_J = 25^\circ C$, Unless Otherwise Specified)	Characteristic Values		
		Min.	Typ.	Max.
BV_{CES}	$I_C = 250\mu A$, $V_{GE} = 0V$	600		V
$V_{GE(th)}$	$I_C = 250\mu A$, $V_{CE} = V_{GE}$	3.0		5.5 V
I_{CES}	$V_{CE} = V_{CES}$, $V_{GE} = 0V$ $T_J = 125^\circ C$			50 μA 4 mA
I_{GES}	$V_{CE} = 0V$, $V_{GE} = \pm 20V$			± 100 nA
$V_{CE(sat)}$	$I_C = 70A$, $V_{GE} = 15V$, Note 1 $T_J = 150^\circ C$		1.50 1.77	V V

Symbol Test Conditions ($T_J = 25^\circ\text{C}$ Unless Otherwise Specified)		Characteristic Values		
		Min.	Typ.	Max.
g_{fs}	$I_C = 60\text{A}, V_{CE} = 10\text{V}, \text{Note 1}$	22	40	S
C_{ies}	$V_{CE} = 25\text{V}, V_{GE} = 0\text{V}, f = 1\text{MHz}$		4860	pF
C_{oes}			475	pF
C_{res}			83	pF
Q_g	$I_C = 70\text{A}, V_{GE} = 15\text{V}, V_{CE} = 0.5 \cdot V_{CES}$		143	nC
Q_{ge}			37	nC
Q_{gc}			60	nC
$t_{d(on)}$	Inductive load, $T_J = 25^\circ\text{C}$ $I_C = 70\text{A}, V_{GE} = 15\text{V}$ $V_{CE} = 360\text{V}, R_G = 2\Omega$ Note 2		30	ns
t_{ri}			70	ns
E_{on}			1.9	mJ
$t_{d(off)}$			120	ns
t_{fi}			150	ns
E_{off}			2.0	2.8 mJ
$t_{d(on)}$	Inductive load, $T_J = 150^\circ\text{C}$ $I_C = 70\text{A}, V_{GE} = 15\text{V}$ $V_{CE} = 360\text{V}, R_G = 2\Omega$ Note 2		32	ns
t_{ri}			60	ns
E_{on}			2.3	mJ
$t_{d(off)}$			150	ns
t_{fi}			200	ns
E_{off}			2.8	mJ
R_{thJC}				0.31 $^\circ\text{C/W}$
R_{thCS}		0.15		$^\circ\text{C/W}$

ISOPLUS247 (IXXR) Outline

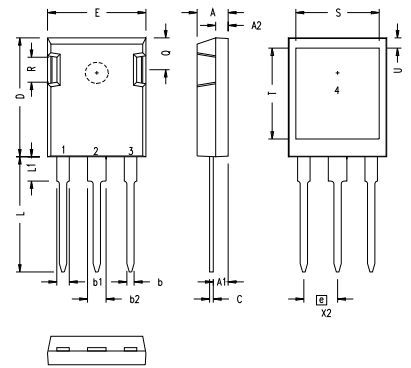

SYM	INCHES		MILLIMETERS	
	MIN	MAX	MIN	MAX
A	.190	.205	4.83	5.21
A1	.090	.100	2.29	2.54
A2	.075	.085	1.91	2.16
b	.045	.055	1.14	1.40
b1	.075	.084	1.91	2.13
b2	.115	.123	2.92	3.12
C	.024	.031	0.61	0.80
D	.819	.840	20.80	21.34
E	.620	.635	15.75	16.13
e	.215 BSC		5.45 BSC	
L	.780	.800	19.81	20.32
L1	.150	.170	3.81	4.32
Q	.220	.244	5.59	6.20
R	.170	.190	4.32	4.83
S	.520	.540	13.21	13.72
T	.620	.640	15.75	16.26
U	.065	.080	1.65	2.03

- 1 - Gate
- 2,4 - Collector
- 3 - Emitter

Reverse Diode (FRED)

Symbol Test Conditions ($T_J = 25^\circ\text{C}$ Unless Otherwise Specified)		Characteristic Values		
		Min.	Typ.	Max.
V_F	$I_F = 60\text{A}, V_{GE} = 0\text{V}, \text{Note 1}$ $T_J = 150^\circ\text{C}$		1.6	2.0 V
			1.4	1.8 V
I_{RM}	$I_F = 60\text{A}, V_{GE} = 0\text{V}, T_J = 100^\circ\text{C}$ $-di_F/dt = 200\text{A}/\mu\text{s}, V_R = 300\text{V}$		8.3	A
t_{rr}			140	ns
R_{thJC}				0.62 $^\circ\text{C/W}$

Notes:

1. Pulse test, $t \leq 300\mu\text{s}$, duty cycle, $d \leq 2\%$.
2. Switching times & energy losses may increase for higher $V_{CE}(\text{clamp})$, T_J or R_G .

ADVANCE TECHNICAL INFORMATION

The product presented herein is under development. The Technical Specifications offered are derived from a subjective evaluation of the design, based upon prior knowledge and experience, and constitute a "considered reflection" of the anticipated result. IXYS reserves the right to change limits, test conditions, and dimensions without notice.

IXYS Reserves the Right to Change Limits, Test Conditions, and Dimensions.

IXYS MOSFETs and IGBTs are covered by one or more of the following U.S. patents:	4,835,592	4,931,844	5,049,961	5,237,481	6,162,665	6,404,065 B1	6,683,344	6,727,585	7,005,734 B2	7,157,338B2
	4,850,072	5,017,508	5,063,307	5,381,025	6,259,123 B1	6,534,343	6,710,405 B2	6,759,692	7,063,975 B2	
	4,881,106	5,034,796	5,187,117	5,486,715	6,306,728 B1	6,583,505	6,710,463	6,771,478 B2	7,071,537	

Fig. 1. Output Characteristics @ $T_J = 25^\circ\text{C}$

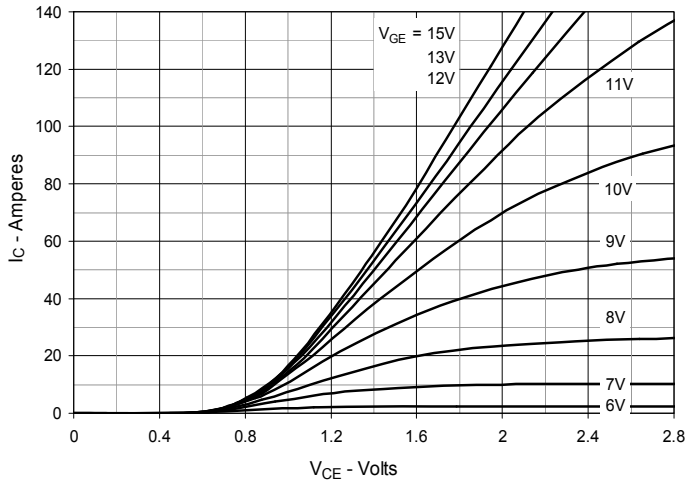

Fig. 2. Extended Output Characteristics @ $T_J = 25^\circ\text{C}$

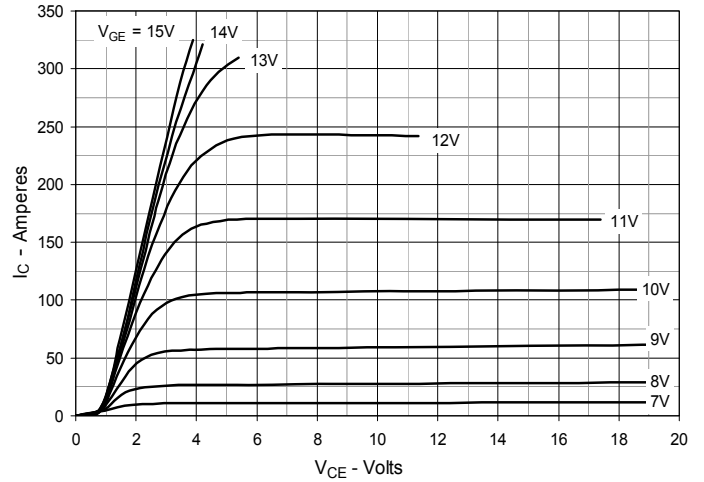

Fig. 3. Output Characteristics @ $T_J = 150^\circ\text{C}$

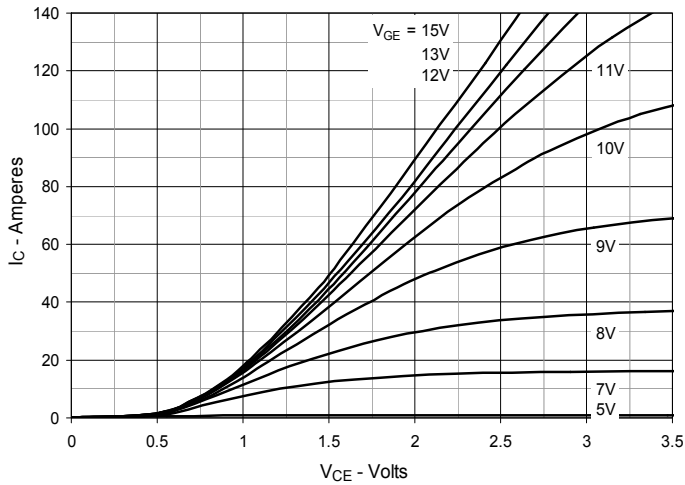

Fig. 4. Dependence of $V_{CE(sat)}$ on Junction Temperature

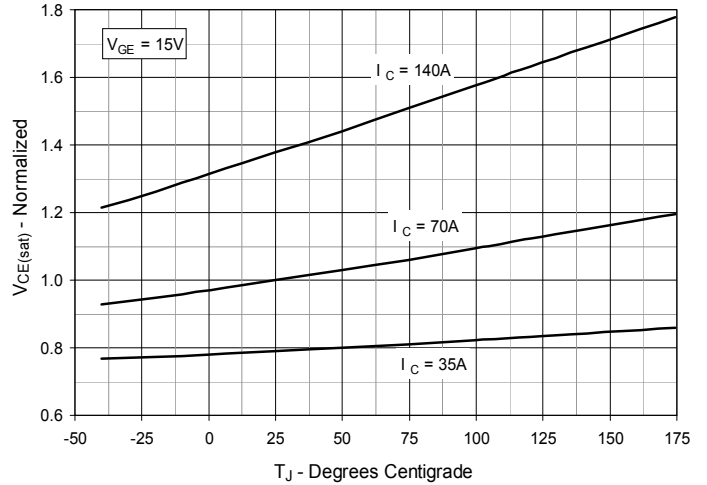

Fig. 5. Collector-to-Emitter Voltage vs. Gate-to-Emitter Voltage

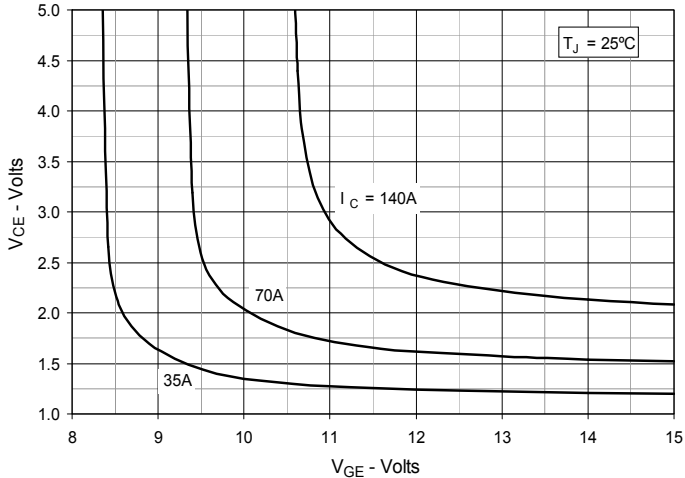

Fig. 6. Input Admittance

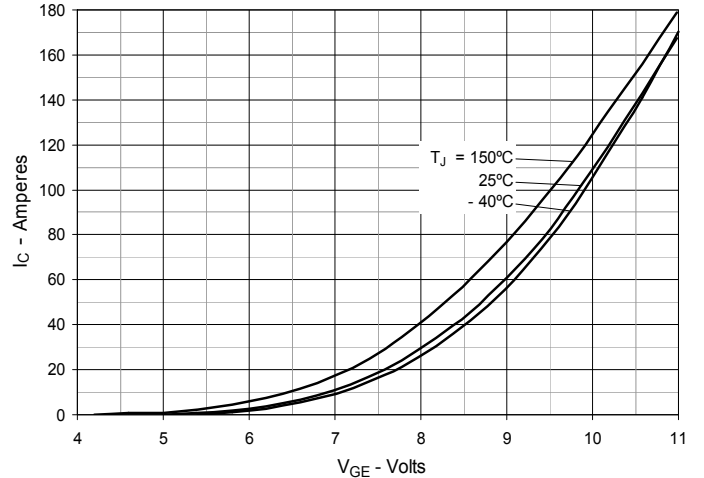

Fig. 7. Transconductance

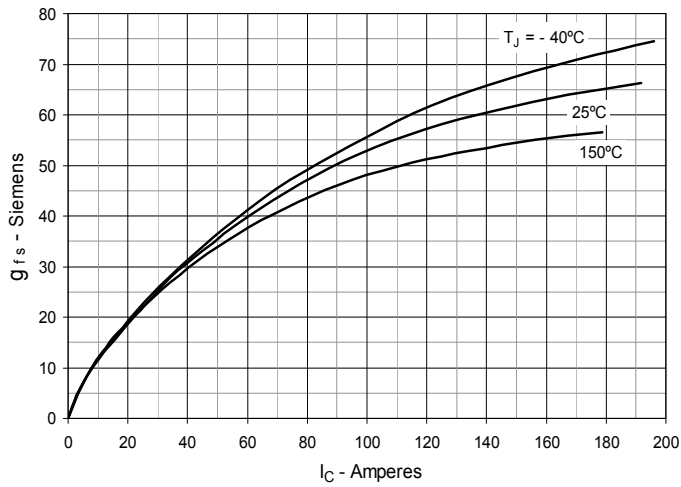

Fig. 8. Gate Charge

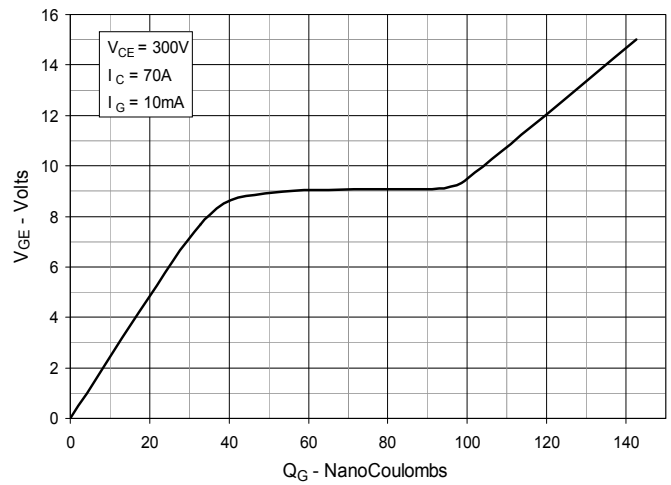

Fig. 9. Capacitance

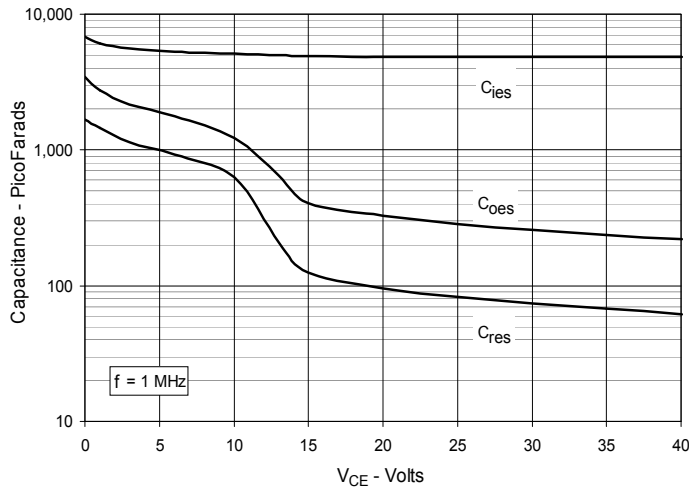

Fig. 10. Reverse-Bias Safe Operating Area

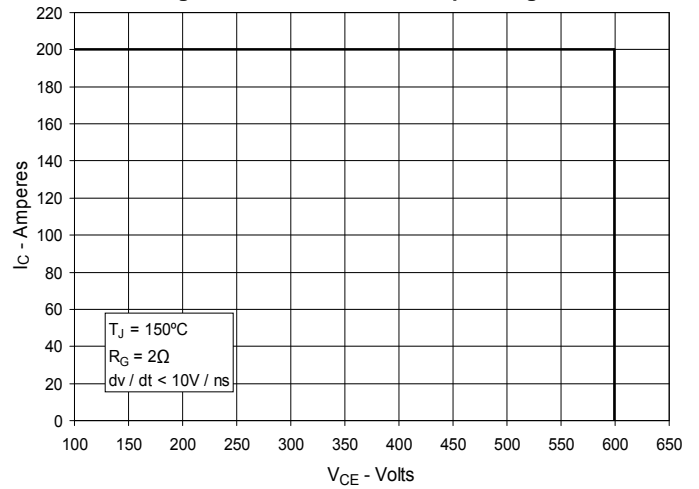

Fig. 11. Forward-Bias Safe Operating Area

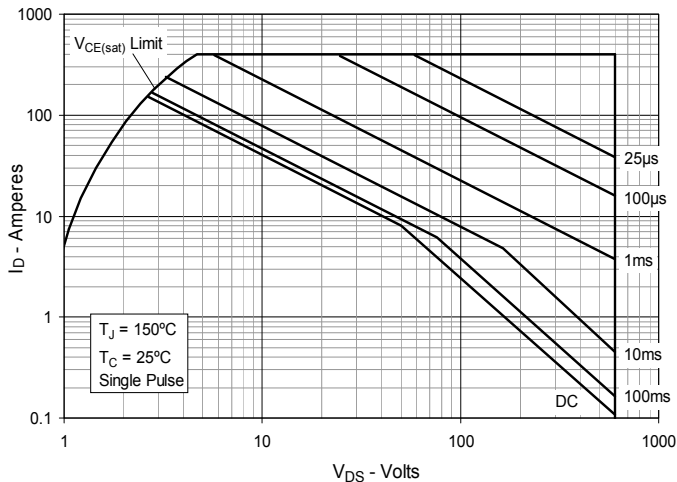

Fig. 12. Maximum Transient Thermal Impedance

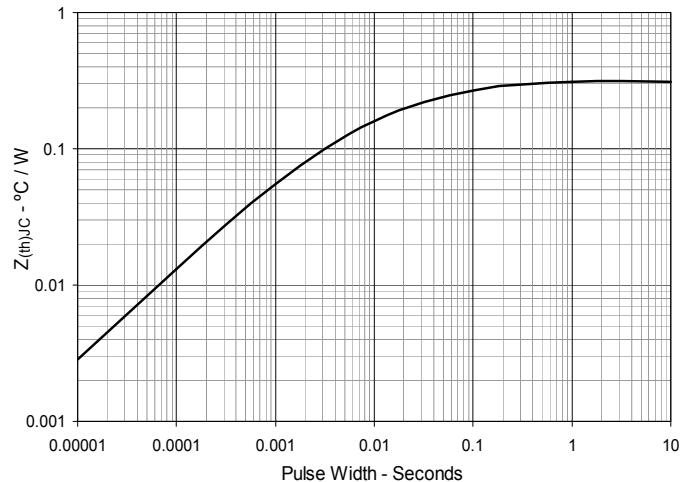

Fig. 13. Inductive Switching Energy Loss vs. Gate Resistance

Fig. 14. Inductive Switching Energy Loss vs. Collector Current

Fig. 15. Inductive Switching Energy Loss vs. Junction Temperature

Fig. 16. Inductive Turn-off Switching Times vs. Gate Resistance

Fig. 17. Inductive Turn-off Switching Times vs. Collector Current

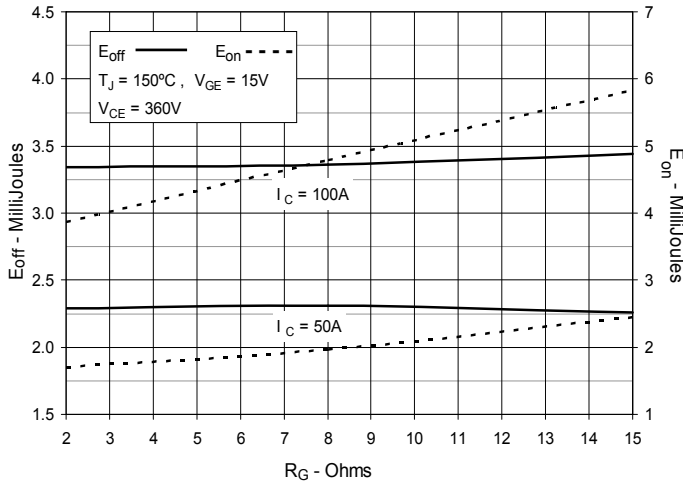
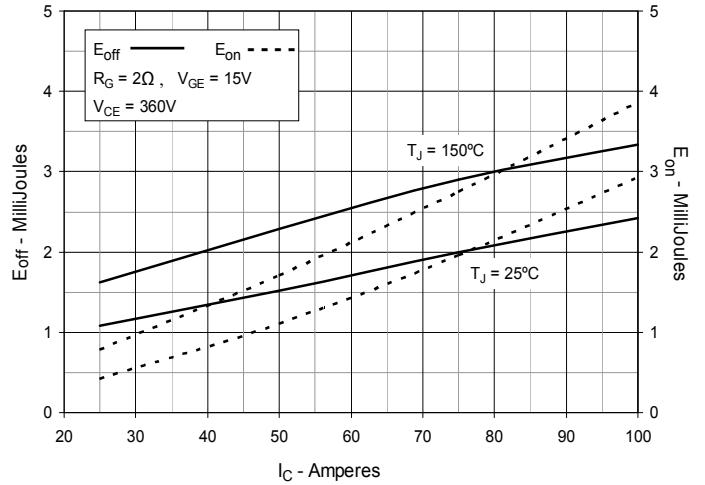
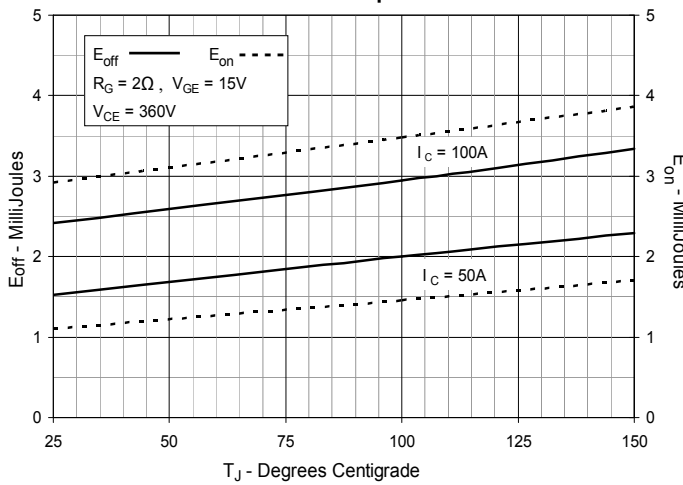
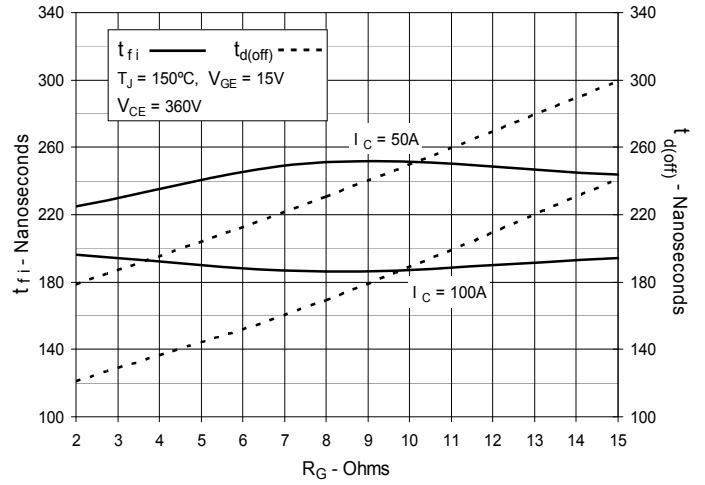
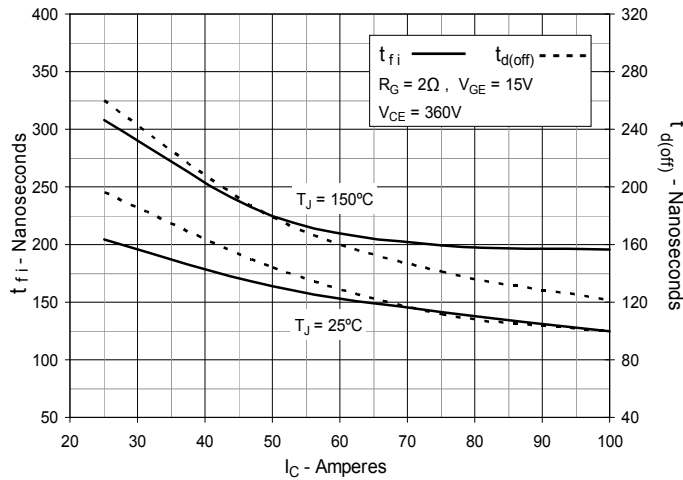
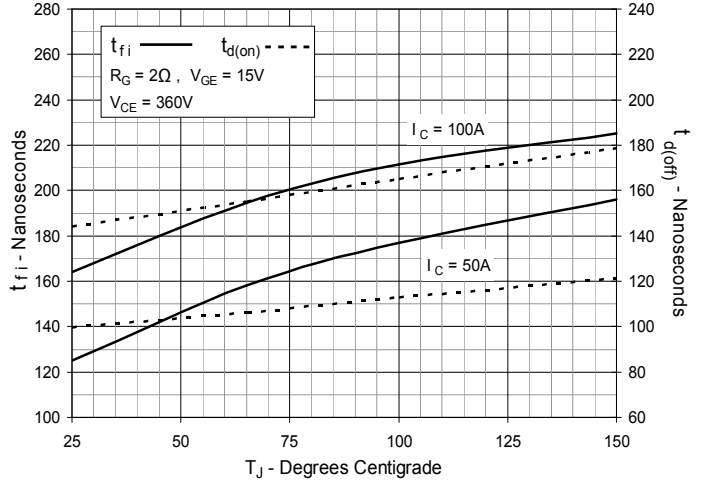
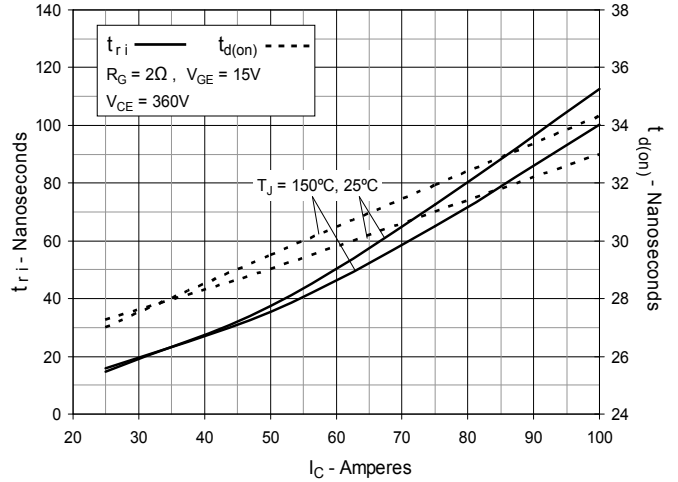
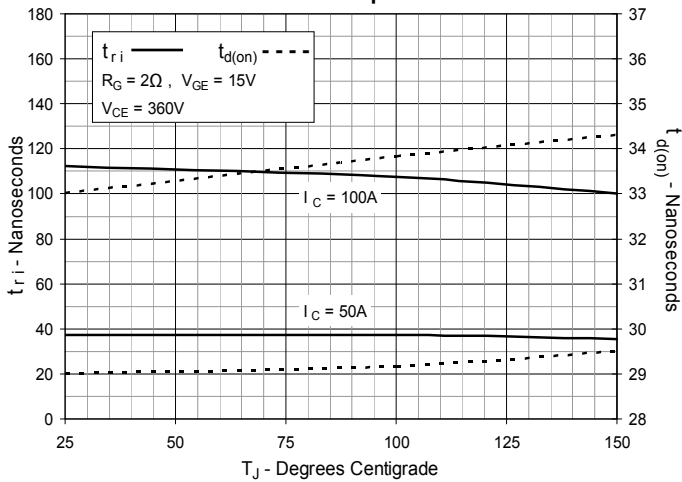
Fig. 18. Inductive Turn-off Switching Times vs. Junction Temperature

Fig. 19. Inductive Turn-on Switching Times vs. Gate Resistance

Fig. 20. Inductive Turn-on Switching Times vs. Collector Current

Fig. 21. Inductive Turn-on Switching Times vs. Junction Temperature

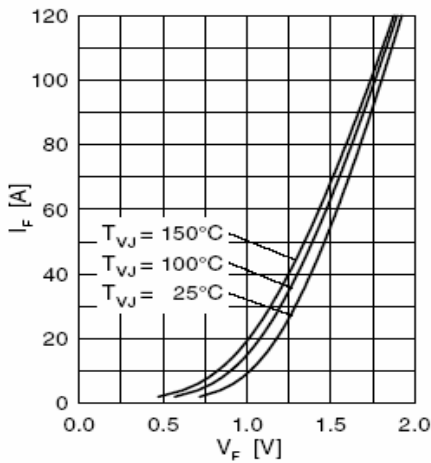

Fig. 22 Forward Current I_F vs. V_F

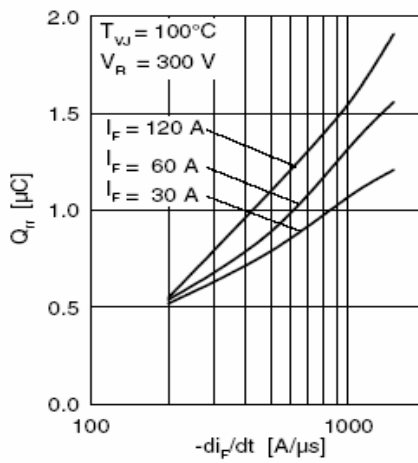

Fig. 23 Typ. Reverse Recovery Charge Q_{rr}

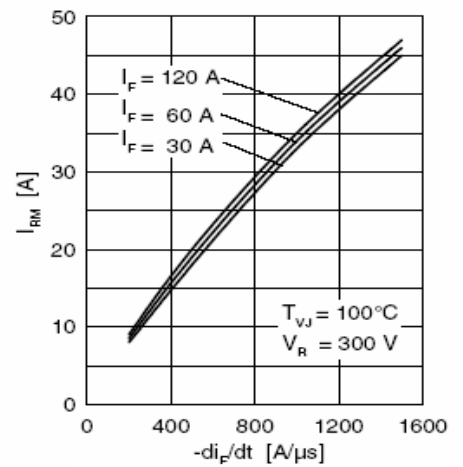

Fig. 24 Typ. Peak Reverse Current I_{RM}

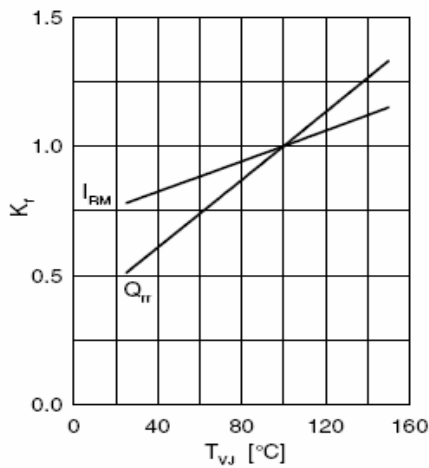

Fig. 25 Typ. Dynamic Parameters Q_{rr} , I_{RM}

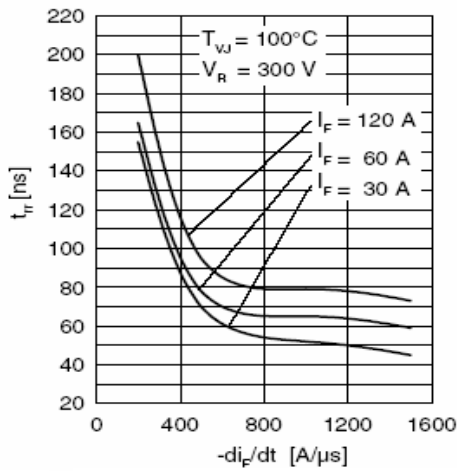

Fig. 26 Typ. Recovery Time t_{tr}

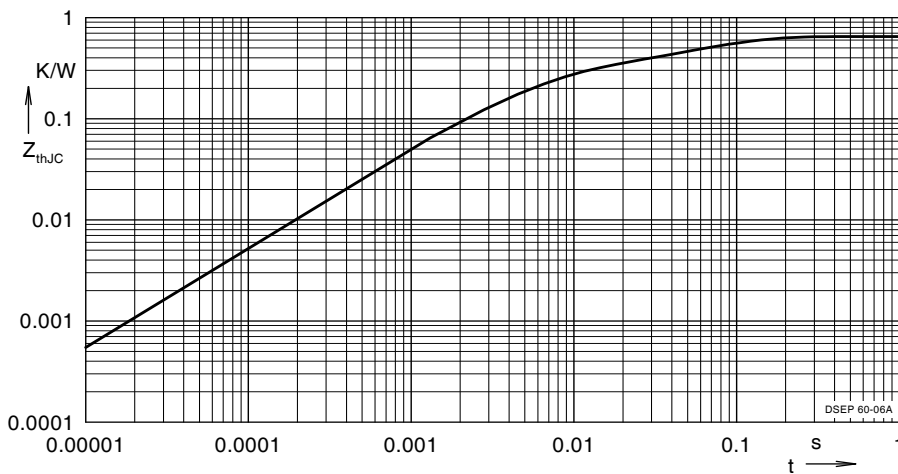

Fig. 27. Maximum Transient Thermal Impedance