

**Trench™ HiperFET™  
Power MOSFETs**
**IXFT120N25T  
IXFH120N25T**

$$V_{DSS} = 250V$$

$$I_{D25} = 120A$$

$$R_{DS(on)} \leq 23m\Omega$$

N-Channel Enhancement Mode  
Avalanche Rated  
Fast Intrinsic Rectifier



TO-268 (IXFT)

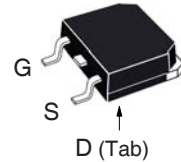

TO-247 (IXFH)

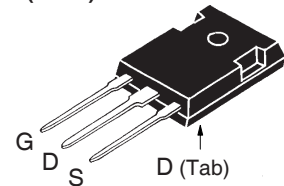

G = Gate      D = Drain  
S = Source    Tab = Drain

| Symbol     | Test Conditions                                                          | Maximum Ratings |                  |
|------------|--------------------------------------------------------------------------|-----------------|------------------|
| $V_{DSS}$  | $T_J = 25^\circ\text{C}$ to $150^\circ\text{C}$                          | 250             | V                |
| $V_{DGR}$  | $T_J = 25^\circ\text{C}$ to $150^\circ\text{C}$ , $R_{GS} = 1M\Omega$    | 250             | V                |
| $V_{GSS}$  | Continuous                                                               | $\pm 20$        | V                |
| $V_{GSM}$  | Transient                                                                | $\pm 30$        | V                |
| $I_{D25}$  | $T_C = 25^\circ\text{C}$                                                 | 120             | A                |
| $I_{DM}$   | $T_C = 25^\circ\text{C}$ , Pulse Width Limited by $T_{JM}$               | 300             | A                |
| $I_A$      | $T_C = 25^\circ\text{C}$                                                 | 60              | A                |
| $E_{AS}$   | $T_C = 25^\circ\text{C}$                                                 | 500             | mJ               |
| $P_D$      | $T_C = 25^\circ\text{C}$                                                 | 890             | W                |
| $dv/dt$    | $I_S \leq I_{DM}$ , $V_{DD} \leq V_{DSS}$ , $T_J \leq 150^\circ\text{C}$ | 20              | V/ns             |
| $T_J$      |                                                                          | -55 to +150     | $^\circ\text{C}$ |
| $T_{JM}$   |                                                                          | +150            | $^\circ\text{C}$ |
| $T_{stg}$  |                                                                          | -55 to +150     | $^\circ\text{C}$ |
| $T_L$      | 1.6mm (0.063in) from Case for 10s                                        | 300             | $^\circ\text{C}$ |
| $T_{SOLD}$ | Plastic Body for 10s                                                     | 260             | $^\circ\text{C}$ |
| $M_d$      | Mounting Torque (TO-247)                                                 | 1.13/10         | Nm/lb.in.        |
| Weight     | TO-268                                                                   | 4               | g                |
|            | TO-247                                                                   | 6               | g                |

**Features**

- International Standard Packages
- Avalanche Rated
- High Current Handling Capability
- Fast Intrinsic Rectifier
- Low  $R_{DS(on)}$

**Advantages**

- Easy to Mount
- Space Savings
- High Power Density

**Applications**

- DC-DC Converters
- Battery Chargers
- Switch-Mode and Resonant-Mode Power Supplies
- DC Choppers
- AC Motor Drives
- Uninterruptible Power Supplies
- High Speed Power Switching Applications

| Symbol       | Test Conditions<br>( $T_J = 25^\circ\text{C}$ , Unless Otherwise Specified) | Characteristic Values |      |                  |
|--------------|-----------------------------------------------------------------------------|-----------------------|------|------------------|
|              |                                                                             | Min.                  | Typ. | Max.             |
| $BV_{DSS}$   | $V_{GS} = 0V$ , $I_D = 1mA$                                                 | 250                   |      | V                |
| $V_{GS(th)}$ | $V_{DS} = V_{GS}$ , $I_D = 4mA$                                             | 3.0                   |      | 5.0 V            |
| $I_{GSS}$    | $V_{GS} = \pm 20V$ , $V_{DS} = 0V$                                          |                       |      | $\pm 200$ nA     |
| $I_{DSS}$    | $V_{DS} = V_{DSS}$ , $V_{GS} = 0V$<br>$T_J = 125^\circ\text{C}$             |                       |      | 25 $\mu\text{A}$ |
|              |                                                                             |                       |      | 1.5 mA           |
| $R_{DS(on)}$ | $V_{GS} = 10V$ , $I_D = 0.5 \cdot I_{D25}$ , Note 1                         |                       |      | 23 m $\Omega$    |

| Symbol       | Test Conditions<br>( $T_J = 25^\circ\text{C}$ , Unless Otherwise Specified)                                                                  | Characteristic Values |      |                         |
|--------------|----------------------------------------------------------------------------------------------------------------------------------------------|-----------------------|------|-------------------------|
|              |                                                                                                                                              | Min.                  | Typ. | Max.                    |
| $g_{fs}$     | $V_{DS} = 10\text{V}, I_D = 0.5 \cdot I_{D25}$ , Note 1                                                                                      | 65                    | 105  | S                       |
| $C_{iss}$    | $V_{GS} = 0\text{V}, V_{DS} = 25\text{V}, f = 1\text{MHz}$                                                                                   |                       | 11.3 | nF                      |
| $C_{oss}$    |                                                                                                                                              |                       | 1025 | pF                      |
| $C_{rss}$    |                                                                                                                                              |                       | 136  | pF                      |
| $t_{d(on)}$  | <b>Resistive Switching Times</b><br>$V_{GS} = 10\text{V}, V_{DS} = 0.5 \cdot V_{DSS}, I_D = 0.5 \cdot I_{D25}$<br>$R_G = 2\Omega$ (External) |                       | 32   | ns                      |
| $t_r$        |                                                                                                                                              |                       | 16   | ns                      |
| $t_{d(off)}$ |                                                                                                                                              |                       | 46   | ns                      |
| $t_f$        |                                                                                                                                              |                       | 19   | ns                      |
| $Q_{g(on)}$  |                                                                                                                                              |                       | 180  | nC                      |
| $Q_{gs}$     | $V_{GS} = 10\text{V}, V_{DS} = 0.5 \cdot V_{DSS}, I_D = 0.5 \cdot I_{D25}$                                                                   |                       | 60   | nC                      |
| $Q_{gd}$     |                                                                                                                                              |                       | 47   | nC                      |
| $R_{thJC}$   | TO-247                                                                                                                                       |                       |      | 0.14 $^\circ\text{C/W}$ |
| $R_{thCS}$   |                                                                                                                                              |                       | 0.21 | $^\circ\text{C/W}$      |

### Source-Drain Diode

| Symbol   | Test Conditions<br>( $T_J = 25^\circ\text{C}$ , Unless Otherwise Specified)                      | Characteristic Values |      |               |
|----------|--------------------------------------------------------------------------------------------------|-----------------------|------|---------------|
|          |                                                                                                  | Min.                  | Typ. | Max.          |
| $I_S$    | $V_{GS} = 0\text{V}$                                                                             |                       |      | 120 A         |
| $I_{SM}$ | Repetitive, Pulse Width Limited by $T_{JM}$                                                      |                       |      | 480 A         |
| $V_{SD}$ | $I_F = 100\text{A}, V_{GS} = 0\text{V}$ , Note 1                                                 |                       |      | 1.4 V         |
| $t_{rr}$ | $I_F = 60\text{A}, -di/dt = 100\text{A}/\mu\text{s},$<br>$V_R = 100\text{V}, V_{GS} = 0\text{V}$ |                       | 108  | ns            |
| $I_{RM}$ |                                                                                                  |                       | 21   | A             |
| $Q_{RM}$ |                                                                                                  |                       | 1.1  | $\mu\text{C}$ |

Note 1. Pulse test,  $t \leq 300\mu\text{s}$ , duty cycle,  $d \leq 2\%$ .

### PRELIMINARY TECHNICAL INFORMATION

The product presented herein is under development. The Technical Specifications offered are derived from data gathered during objective characterizations of preliminary engineering lots; but also may yet contain some information supplied during a pre-production design evaluation. IXYS reserves the right to change limits, test conditions, and dimensions without notice.

IXYS Reserves the Right to Change Limits, Test Conditions, and Dimensions.

IXYS MOSFETs and IGBTs are covered 4,835,592 4,931,844 5,049,961 5,237,481 6,162,665 6,404,065 B1 6,683,344 6,727,585 7,005,734 B2 7,157,338B2  
by one or more of the following U.S. patents: 4,850,072 5,017,508 5,063,307 5,381,025 6,259,123 B1 6,534,343 6,710,405 B2 6,759,692 7,063,975 B2  
4,881,106 5,034,796 5,187,117 5,486,715 6,306,728 B1 6,583,505 6,710,463 6,771,478 B2 7,071,537

### TO-268 Outline

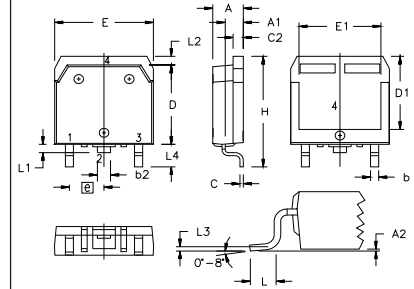

Terminals: 1 - Gate 2,4 - Drain  
3 - Source

| SYM | INCHES   |      | MILLIMETERS |       |
|-----|----------|------|-------------|-------|
|     | MIN      | MAX  | MIN         | MAX   |
| A   | .193     | .201 | 4.90        | 5.10  |
| A1  | .106     | .114 | 2.70        | 2.90  |
| A2  | .001     | .010 | 0.02        | 0.25  |
| b   | .045     | .057 | 1.15        | 1.45  |
| b2  | .075     | .083 | 1.90        | 2.10  |
| C   | .016     | .026 | 0.40        | 0.65  |
| C2  | .057     | .063 | 1.45        | 1.60  |
| D   | .543     | .551 | 13.80       | 14.00 |
| D1  | .488     | .500 | 12.40       | 12.70 |
| E   | .624     | .632 | 15.85       | 16.05 |
| E1  | .524     | .535 | 13.30       | 13.60 |
| e   | .215 BSC |      | 5.45 BSC    |       |
| H   | .736     | .752 | 18.70       | 19.10 |
| L   | .094     | .106 | 2.40        | 2.70  |
| L1  | .047     | .055 | 1.20        | 1.40  |
| L2  | .039     | .045 | 1.00        | 1.15  |
| L3  | .010 BSC |      | 0.25 BSC    |       |
| L4  | .150     | .161 | 3.80        | 4.10  |

### TO-247 Outline

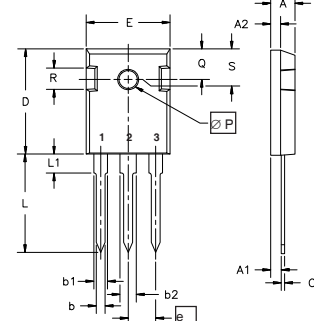

Terminals: 1 - Gate 2 - Drain  
3 - Source

| Dim.           | Millimeter |       | Inches  |       |
|----------------|------------|-------|---------|-------|
|                | Min.       | Max.  | Min.    | Max.  |
| A              | 4.7        | 5.3   | .185    | .209  |
| A <sub>1</sub> | 2.2        | 2.54  | .087    | .102  |
| A <sub>2</sub> | 2.2        | 2.6   | .059    | .098  |
| b              | 1.0        | 1.4   | .040    | .055  |
| b <sub>1</sub> | 1.65       | 2.13  | .065    | .084  |
| b <sub>2</sub> | 2.87       | 3.12  | .113    | .123  |
| C              | .4         | .8    | .016    | .031  |
| D              | 20.80      | 21.46 | .819    | .845  |
| E              | 15.75      | 16.26 | .610    | .640  |
| e              | 5.20       | 5.72  | 0.205   | 0.225 |
| L              | 19.81      | 20.32 | .780    | .800  |
| L1             |            | 4.50  |         | .177  |
| ∅P             | 3.55       | 3.65  | .140    | .144  |
| Q              | 5.89       | 6.40  | 0.232   | 0.252 |
| R              | 4.32       | 5.49  | .170    | .216  |
| S              | 6.15 BSC   |       | 242 BSC |       |

Fig. 1. Output Characteristics @  $T_J = 25^\circ\text{C}$

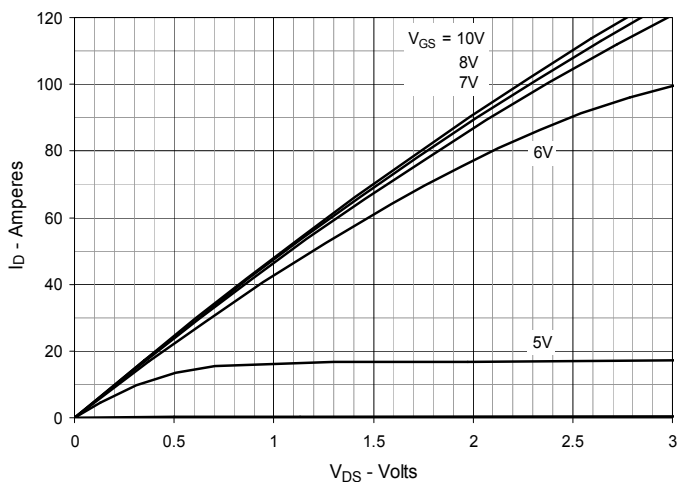

Fig. 2. Extended Output Characteristics @  $T_J = 25^\circ\text{C}$

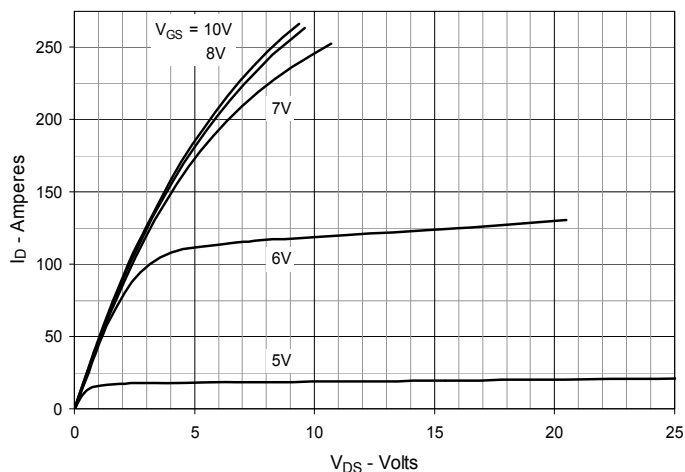

Fig. 3. Output Characteristics @  $T_J = 125^\circ\text{C}$

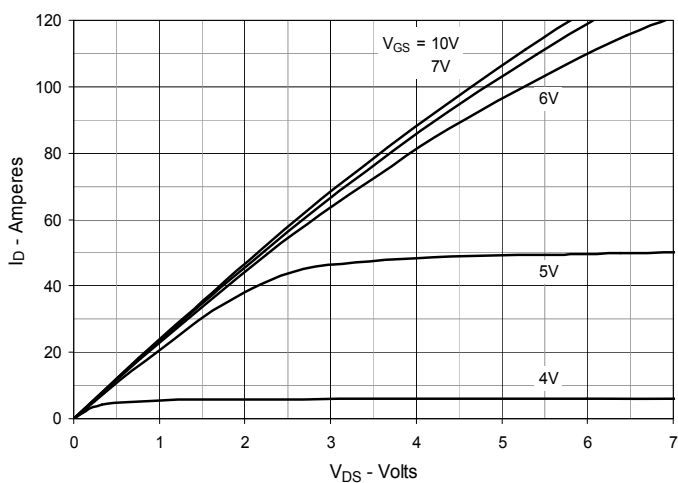

Fig. 4.  $R_{DS(on)}$  Normalized to  $I_D = 60\text{A}$  Value vs. Junction Temperature

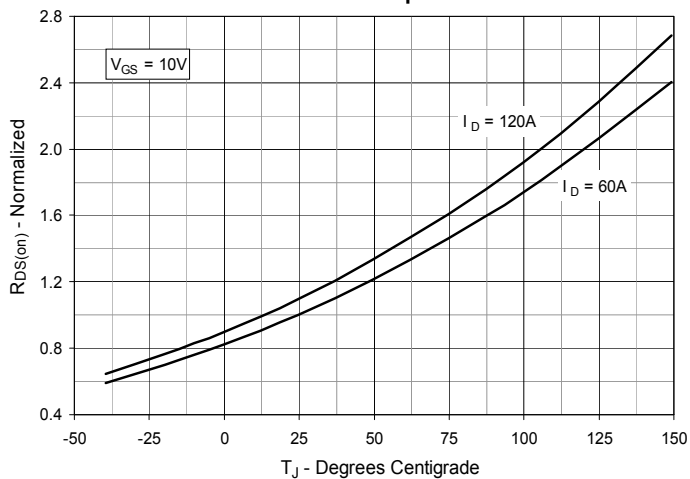

Fig. 5.  $R_{DS(on)}$  Normalized to  $I_D = 60\text{A}$  Value vs. Drain Current

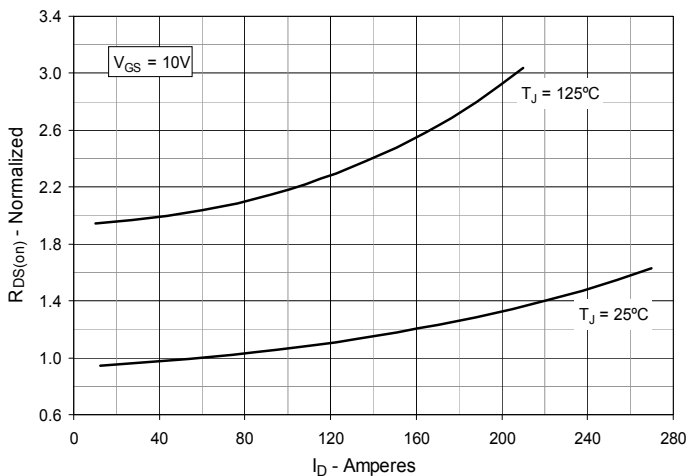
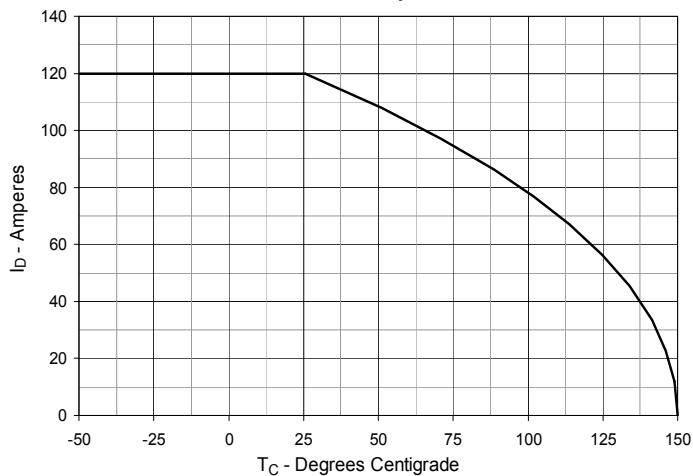
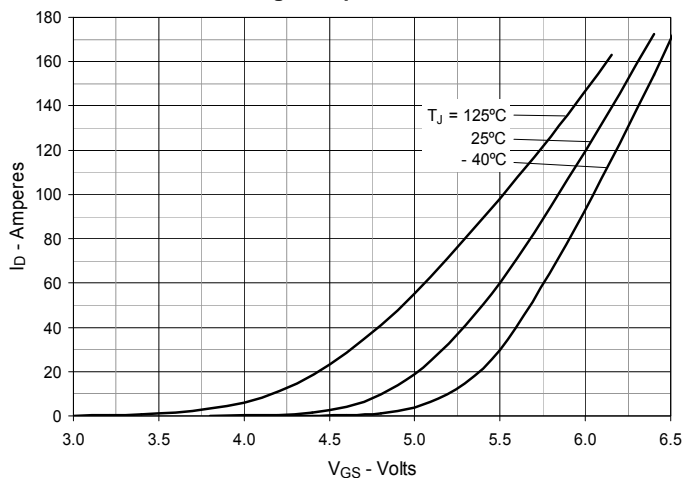

Fig. 6. Maximum Drain Current vs. Case Temperature



**Fig. 7. Input Admittance**



**Fig. 8. Transconductance**

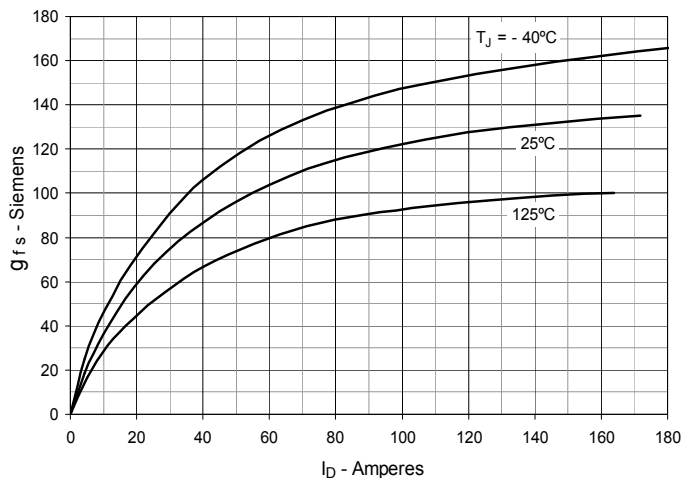

**Fig. 9. Forward Voltage Drop of Intrinsic Diode**

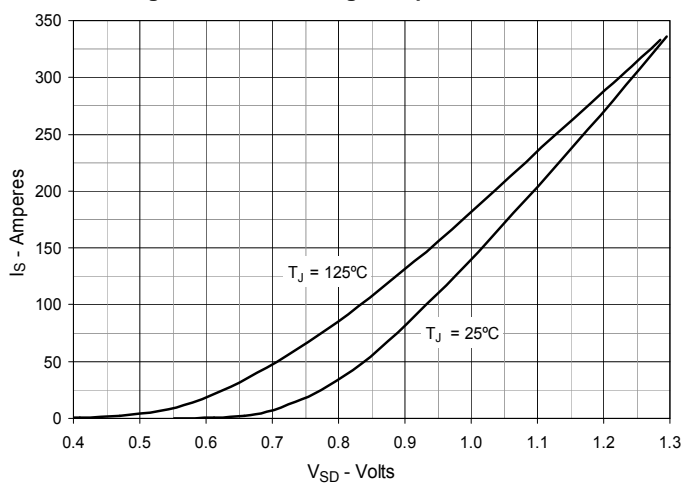

**Fig. 10. Gate Charge**

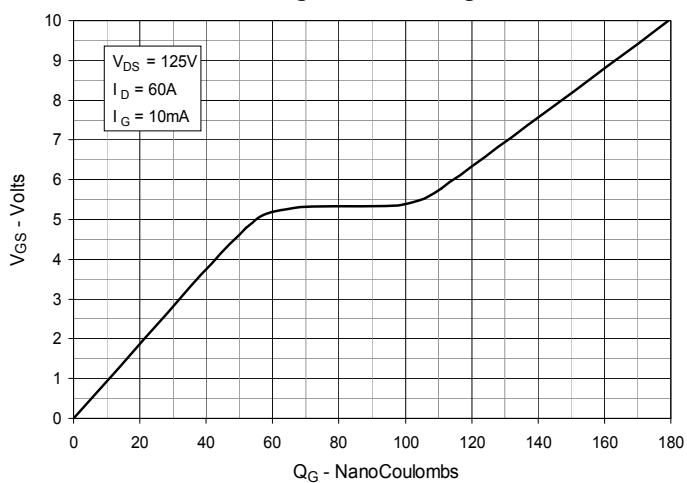

**Fig. 11. Capacitance**

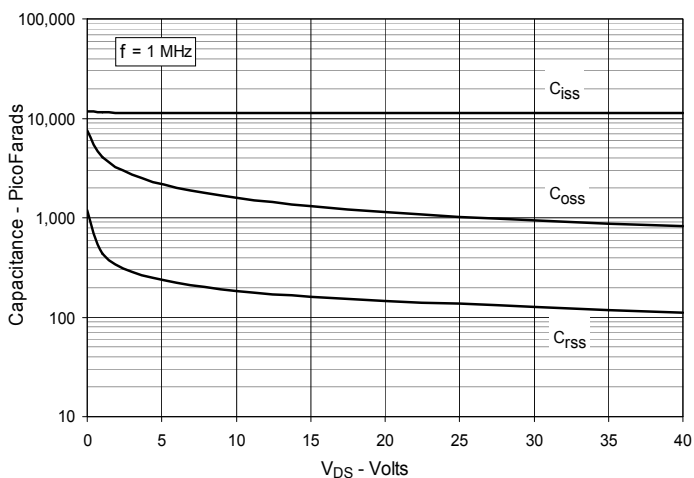

**Fig. 12. Forward-Bias Safe Operating Area @  $T_C = 25^\circ\text{C}$**

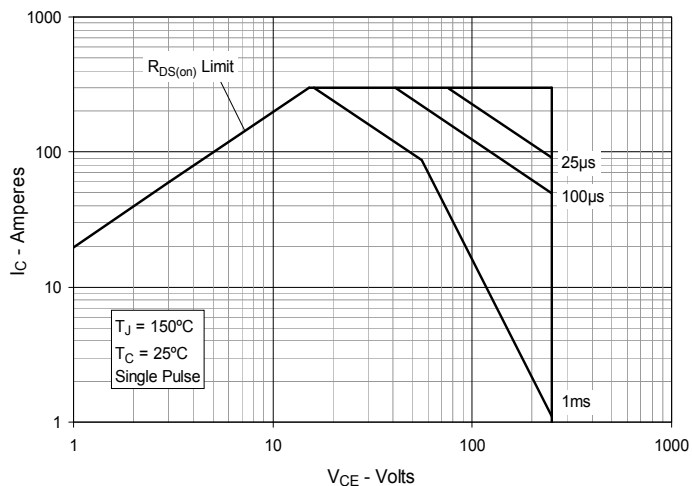

**Fig. 13. Resistive Turn-on Rise Time vs. Junction Temperature**

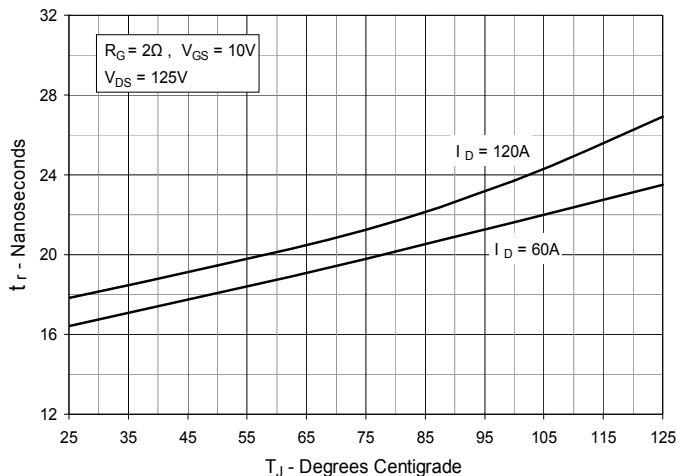

**Fig. 14. Resistive Turn-on Rise Time vs. Drain Current**

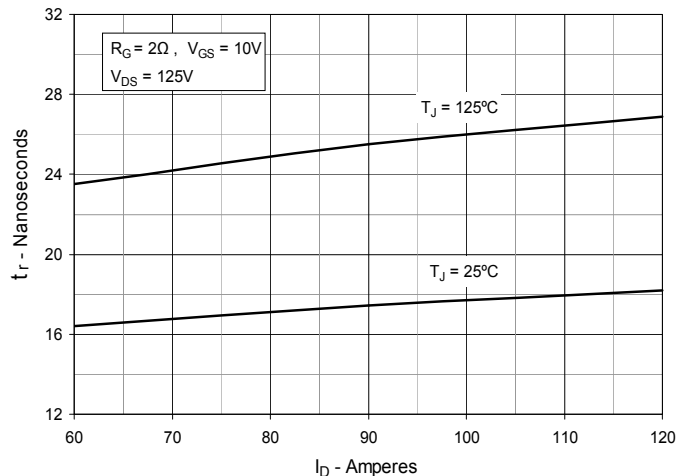

**Fig. 15. Resistive Turn-on Switching Times vs. Gate Resistance**

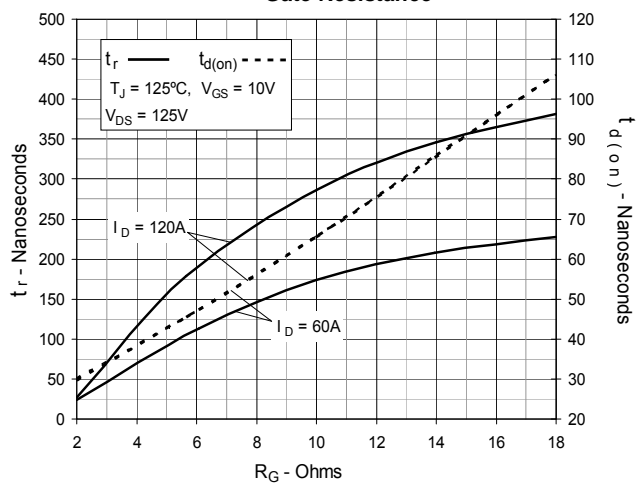

**Fig. 16. Resistive Turn-off Switching Times vs. Junction Temperature**

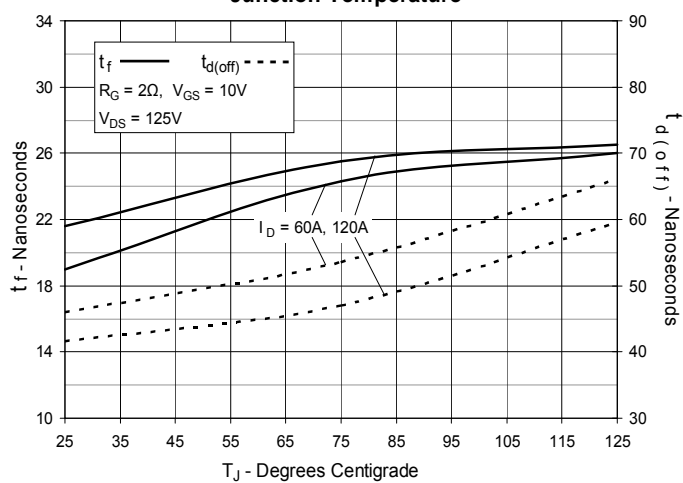

**Fig. 17. Resistive Turn-off Switching Times vs. Drain Current**

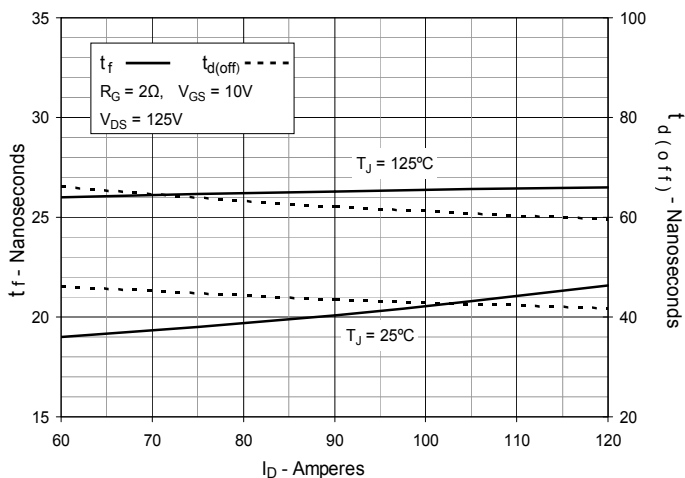

**Fig. 18. Resistive Turn-off Switching Times vs. Gate Resistance**

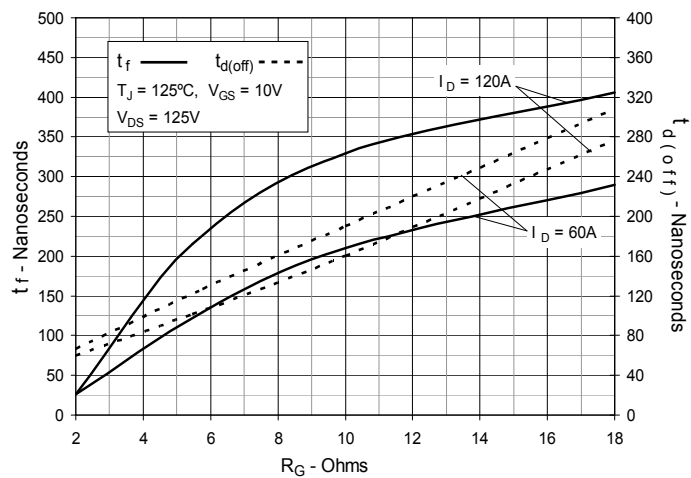

Fig. 19. Maximum Transient Thermal Impedance

