

Detector Switch Micro Switch Type with Female Connector Terminal

SPVQ5 Series



A connector type detector switch eliminates the need for solder.

Detector

Push

Slide

Rotary

Encoders

Power

Dual-in-line
Package Type

TACT Switch™

Custom-
Products

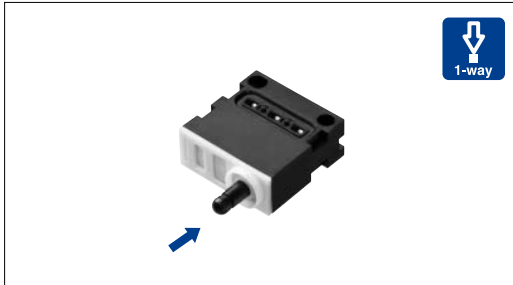

Typical Specifications

Items		Specifications
Rating(max.)(min.) (Resistive load)		0.1A 12V DC/50 μ A 5V DC
Contact resistance (Initial/After operating life)		500m max./1 max.
Operating force		2N max.
Operating life	Without load	300,000cycles
	With load	300,000cycles(0.1A 12V DC)

Product Line

Poles	Positions	Terminal type	Minimum order unit(pcs)	Product No.
1	2	Female connector type	7,500	SPVQ510101

Dimensions

Unit:mm

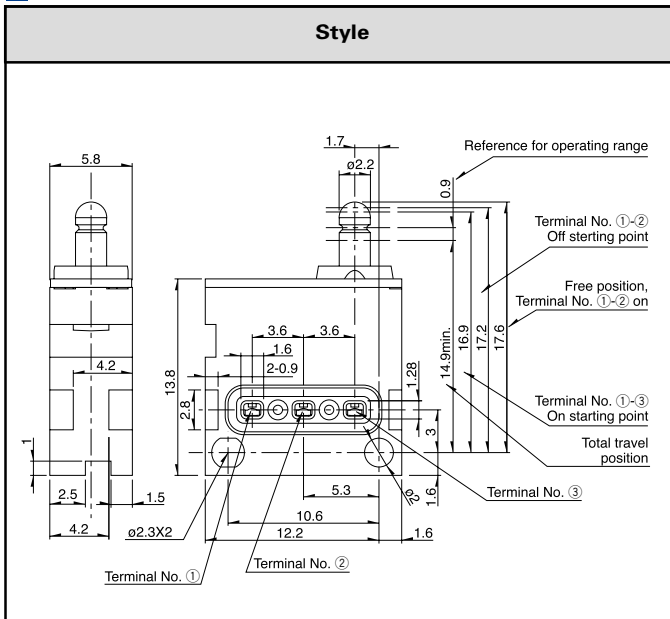

Terminal Type

Unit:mm

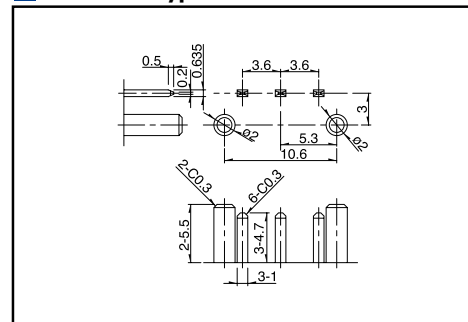



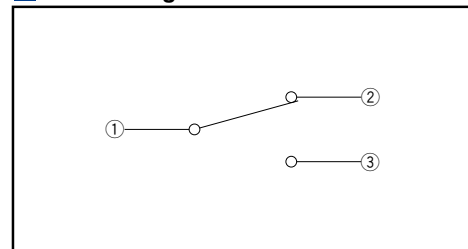















Circuit Diagram



Note

Please place purchase orders per minimum order unit(integer).

List of Varieties (General-purpose Type / Water-proof Type / Telephone-hook Type)

Series	General-purpose Type		Water-proof Type					Telephone-hook Type	
	SSCW	SPVQ5	SPVQ1	SPVQ3	SPVQ4	SPVQ6	SSCN	SPPY5	
Photo									
Operation type			 	 					
Operating temperature range	-40 to +85							-10 to +60	
Rating(max.) (Resistive load)	0.1A 20V DC	0.1A 12V DC					0.1mA 3V DC min. 50mA 48V DC max.		
Rating(min.) (Resistive load)	100μA 3V DC	50μA 3V DC	50μA 3V DC or 1mA 5V DC	50μA 3V DC	50μA 5V DC	100μA 3V DC	0.1mA 3V DC		
Electrical performance	Initial contact resistance	500m max.						100m max.	
	Insulation resistance	100M min. 250V DC	100M min. 500V DC						
	Voltage proof	250V AC for 1 minute	500V AC for 1 minute						
Mechanical performance	Terminal strength	3N for 1 minute					5N for 1 minute		
	Actuator strength	20N					10N	5N	
Durability	Operating life without Load	100,000cycles 1 max.	300,000cycles 1 max.	300,000cycles or 1,200,000cycles 1 max.	300,000cycles 1 max.		100,000cycles 1 max.	300,000cycles 1 max.	
	Operating life with Load	(0.1mA 12V DC) 100,000cycles 1 max.	(0.1A 12V DC) 300,000cycles 1 max.	(0.1A 12V DC) 300,000cycles or 1,200,000 1 max.	(0.1A 12V DC) 300,000cycles 1 max.		(0.1A 12V DC) 100,000cycles 1 max.	(1mA 3V DC) 300,000cycles 1 max. or (50mA 60V DC) 100,000cycles 1 max.	
Environmental performance	Cold	-40 ± 2 for 500h						-20 ± 2 for 96h	
	Dry heat	85 ± 2 for 500h						85 ± 2 for 96h	
	Damp heat	60 ± 2 , 90 to 95%RH for 500h						40 ± 2 , 90 to 95%RH for 96h	
Dimensions (mm)	W	13.1	13.8	13.3	13	14.7	13.3	13	14.4
	D	11.35		5.8		5.4	5.3	25	28.6
	H	5.3	5.8	8	8.35	7.6	7	5	7.15
Soldering	Manual soldering	300 ± 10 , 3 ⁺ s						350 ± 5 , 3s max.	
	Dip soldering	260 ± 5 , 5 ± 1s							
	Reflow soldering							Please see P.79	
Number of poles	1							2	
Operation force	1N max.	2N max.	2N max. 5.9N max.	1 ± 0.5N	1 ± 0.3N	1 ± 0.5N	2N max.	0.8N max.	
Page	61	62	63	67	73	74	76	77	

- Detector
- Push
- Slide
- Rotary
- Encoders
- Power
- Dual-in-line Package Type
- TACT Switch™
- Custom-Products

Detector Switches Soldering Conditions79
 Detector Switches Cautions80