



ø22 HW Series Control Units

Complete with IP20 finger-safe contact blocks Ensure safety and save wiring time

- The locking lever removable contact block features spring-up screw terminals.
- Self-cleaning rolling action contacts have a raked contact surface.
- Degree of protection: IP65
- A wide range of operating voltages for worldwide application
- UL, CSA approved, and EN compliant

Safety Standards	File No. or Organization
UL 	UL Listing File No. E68961
CSA 	File No. LR92374
EN EN60947-1 EN60947-5-1	 TÜV Rheinland R9551089



Specifications and Ratings

Contact Ratings

Pushbuttons Illuminated Pushbuttons Selector Switches Illuminated Selector Switches Pushbutton Selectors	Contact Block	Type HW-G (HW series)
	Rated Insulation Voltage	
Rated Continuous Current		10A
Contact Ratings by Utilization Category IEC 60947-5-1		AC-15 (A600) DC-13 (P600)

Characteristics

• Contact Ratings by Utilization Category

Operational Voltage		24V	48V	50V	110V	220V	440V	
Operational Current	AC 50/60 Hz	AC-12 Control of resistive loads and solid state loads	10A	—	10A	10A	6A	2A
		AC-15 Control of electromagnetic loads (> 72 VA)	10A	—	7A	5A	3A	1A
	DC	DC-12 Control of resistive loads and solid state loads	8A	4A	—	2.2A	1.1A	—
		DC-13 Control of electromagnets	4A	2A	—	1.1A	0.6A	—

Note: The operational current represents the classification by making and breaking currents (IEC 60947-5-1).
Minimum applicable load: 3V AC/DC, 5 mA (applicable range may vary with operating conditions and load types)

For the control units listed below, the rated current (load switching current) is reduced to a half of the rated operational current of the contact block. The rated insulation voltage (600V) and the rated thermal current (10A) remain unchanged.

- 3-position selector switches which contain J or S following 3 in the Type No. and which have cam code J or S. Example: HW1S-3JT21N1
- All 4-position and 5-position selector switches
- All mono-lever switches
- All pushbutton selectors

HW-G Contact Block

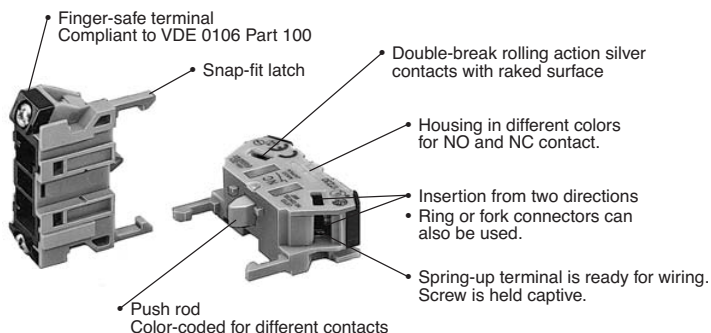

• Contact Block Types

Type No.	HW-G10	HW-G01	HW-G10R	HW-G01R
Contact	NO	NC	NO (early make)	NC (late break)
Housing	Blue	Purple red	Blue	Purple red
Push Rod	Green	Red	Black	White

Transformer Unit







LED Illuminated Unit Specifications

Unit	Color Code ②	Input Type	Operating Voltage	LED Lamp		
				Lamp Base	Type No.	Voltage
Pilot Light Illuminated Pushbutton Illuminated Selector Switch	A: amber G: green PW: pure white R: red S: blue W: white Y: yellow	Full Voltage	6V AC/DC	BA9S/13	LSTD-6②	6V AC/DC ±10%
			12V AC/DC		LSTD-1②	12V AC/DC ±10%
			24V AC/DC		LSTD-2②	24V AC/DC ±10%
		Transformer	100/110V AC/DC 115/120V AC/DC 200/220V AC/DC 230/240V AC/DC 380V AC/DC 400/440V AC/DC 480V AC/DC (50/60 Hz)	LSTD-6②	6V AC/DC ±10%	
DC-DC Converter	110V DC	LSTD-6②	6V AC/DC ±10%			

Incandescent Illuminated Unit Specifications

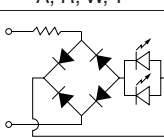
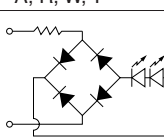
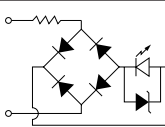
Unit	Color Code ②	Input Type	Operating Voltage	Incandescent Lamp		
				Lamp Base	Type No.	Rating
Pilot Light Illuminated Pushbutton Illuminated Selector Switch	A: amber G: green R: red S: blue W: white	Full Voltage	6V AC/DC	BA9S/13	LS-6	1W (6.3V)
			12V AC/DC		LS-8	1W (18V)
			24V AC/DC		LS-3	1W (30V)
		Transformer	100/110V AC/DC 115/120V AC/DC 200/220V AC/DC 230/240V AC/DC 380V AC/DC 400/440V AC/DC 480V AC/DC (50/60 Hz)	LS-6	1W (6.3V)	

LED Lamp Ratings (LSTD Type)

Type No.	LSTD-6②		LSTD-1②	LSTD-2②
Lamp Base	BA9S/13			
Rated Voltage	6V AC/DC		12V AC/DC	24V AC/DC
Voltage Range	6V AC/DC ±10%		12V AC/DC ±10%	24V AC/DC ±10%
Current Draw	AC	A, R, W, Y: 17 mA G, PW, S: 8 mA	11 mA	11 mA
	DC	A, R, W, Y: 14 mA G, PW, S: 5.5 mA	10 mA	10 mA
Color Code	A (amber), G (green), PW (pure white), R (red), S (blue), W (white), Y (yellow)			
Lamp Base Color	Same as illumination color			
Voltage Marking	Die stamped on the base			
Life (reference value)	Approx. 50,000 hours (The luminance reduces to 50% the initial intensity when used on complete DC.)			
Internal Circuit	A, R, W, Y		A, R, W, Y	
				
	G, PW, S			
			<ul style="list-style-type: none">  LED Chip  Protection Diode  Zener Diode 	

Incandescent Lamp Ratings (LS Type)

Type No.	LS-6	LS-8	LS-2	LS-3
Lamp Base	BA9S/13			
Rated Voltage	6V AC/DC	12V AC/DC	18V AC/DC	24V AC/DC
Wattage	1W (6.3V)	1W (18V)	1W (24V)	1W (30V)
Voltage Marking	Die stamped on the base			
Life (reference value)	Approx. 1,000 hours minimum (mean value when used on the rated voltage)			

ø22 HW Series Control Units

Specifications

Operating Temperature	-25 to +60°C (no freezing) Illuminated units: -25 to +50°C
Storage Temperature	-40 to +80°C
Operating Humidity	45 to 85% RH (no condensation)
Contact Resistance	50 mΩ maximum (initial value)
Insulation Resistance	100 MΩ minimum (500V DC megger)
Dielectric Strength	Between live and dead metal parts: 2,500V AC, 1 minute (Full voltage type illuminated units: 2,000V AC, 1 minute)
Vibration Resistance	Operating extremes: 5 to 55 Hz, amplitude 0.5 mm
Shock Resistance	Damage limits: 1,000 m/s ² Operating extremes: 100 m/s ²
Mechanical Life (minimum operations)	Pushbuttons, Illuminated pushbuttons Momentary: 5,000,000 Maintained: 500,000 Selector switches: 500,000 Key selector switches: 500,000 Illuminated selector switches: 500,000 Pushbutton selectors: 250,000 Mono-lever switches: 250,000
Electrical Life (minimum operations)	Pushbuttons, Illuminated pushbuttons: 500,000 *1 Selector switches: 500,000 *2 Key selector switches: 500,000 *2 Illuminated selector switches: 500,000 *2 Pushbutton selectors: 250,000 *2 Mono-lever switches: 250,000 *3 *1 Switching frequency 1,800 operations/h, duty ratio 40% *2 Switching frequency 1,200 operations/h, duty ratio 40% *3 Switching frequency 900 operations/h, duty ratio 40%

Degree of Protection

Unit	NEMA ICS 6-110	IEC 60529
All units	Type 1, 2, 3, 3R, (3S), 4, 5, 12,13	IP65

Mounting Hole Layout

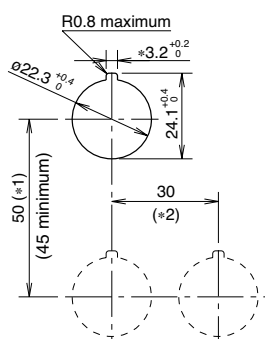

* The 3.2 mm recess is for preventing rotation and is not necessary when the nameplate or anti-rotation ring is not used.

The minimum mounting centers are applicable to switches with one layer of contact blocks (two contact blocks). When two layers of contact blocks are mounted, determine the minimum mounting centers in consideration of convenience for wiring.

• Minimum Mounting Centers

Unit	*1	*2
ø40mm mushroom button	50 mm	40 mm
Pilot light	30 mm	30 mm
Pushbutton selector	50 mm	50 mm
Mono-lever switch	72 mm	72 mm

Note: When using the safety lever lock, determine the vertical spacing (*1) in consideration of convenience for installing and removing the safety lever lock.

Recommended vertical spacing: 100 mm

Ordering Information

The Type No. development charts shown below can be used to specify control units other than those listed on the following pages. Gold-plated silver contacts are also available.

Emergency Stop Switches

For emergency stop purposes, these switches must contain at least one NC contact block.

HW1B-V4 11 R -MAU

- Optional contact
- MAU: Gold-plated silver contact
- Button/lens color code
- Contact arrangement code

01: 1NC	11: 1NO-1NC
02: 2NC	21: 2NO-1NC
12: 1NO-2NC	03: 3NC
31: 3NO-1NC	22: 2NO-2NC
13: 1NO-3NC	04: 4NC

Note:
Push-pull type HW1B-Y2 can have a maximum of two contact blocks.

Pushbuttons

HW1B-M1 11 R -MAU

- Optional contact
- MAU: Gold-plated silver contact
- Button color code
- Contact arrangement code

10: 1NO	01: 1NC
11: 1NO-1NC	20: 2NO
02: 2NC	21: 2NO-1NC
12: 1NO-2NC	30: 3NO
03: 3NC	31: 3NO-1NC
22: 2NO-2NC	13: 1NO-3NC
40: 4NO	04: 4NC

Pilot Lights

HW1P-1 H 2 R

- Lens color code
- Lamp code

0: Without lamp
2: LED (6V: LSTD)
3: LED (12V: LSTD)
4: LED (24V: LSTD)
5: Incandescent (6V: LS-6)
6: Incandescent (12V: LS-8)
7: Incandescent (24V: LS-3)
- Operating voltage code

Q: Full voltage
H: Transformer (100/110V AC)
H2: Transformer (115/120V AC)
M: Transformer (200/220V AC)
M4: Transformer (230/240V AC)
S: Transformer (380V AC)
T: Transformer (400/440V AC)
T8: Transformer (480V AC)
D: DC-DC converter (110V DC)

Note:
Full voltage type is not supplied with a lamp.
Transformer and DC-DC converter types contain an LED lamp (LSTD-6②) or incandescent lamp (LS-6).

Illuminated Pushbuttons

HW1L-M1 11 H 2 R -MAU

- Optional contact
- MAU: Gold-plated silver contact
- Lens color code
- Lamp code

0: Without lamp
2: LED (6V: LSTD)
3: LED (12V: LSTD)
4: LED (24V: LSTD)
5: Incandescent (6V: LS-6)
6: Incandescent (12V: LS-8)
7: Incandescent (24V: LS-3)
- Operating voltage code

Q: Full voltage
H: Transformer (100/110V AC)
H2: Transformer (115/120V AC)
M: Transformer (200/220V AC)
M4: Transformer (230/240V AC)
S: Transformer (380V AC)
T: Transformer (400/440V AC)
T8: Transformer (480V AC)
D: DC-DC converter (110V DC)
- Contact arrangement code

10: 1NO	01: 1NC
11: 1NO-1NC	20: 2NO
02: 2NC	21: 2NO-1NC
12: 1NO-2NC	30: 3NO
03: 3NC	31: 3NO-1NC
22: 2NO-2NC	13: 1NO-3NC
40: 4NO	04: 4NC

Note:
Full voltage type is not supplied with a lamp.
Transformer and DC-DC converter types contain an LED lamp (LSTD-6②) or incandescent lamp (LS-6).
Transformer and DC-DC converter types can have two or four contact blocks only.

Selector Switches

HW1S-3 S T 22N9 -MAU

- Optional contact
- MAU: Gold-plated silver contact
- Contact code
- Knob operator
- Cam code

J
S
(none)

ø22 HW Series Control Units (Ordering Information)

Key Selector Switches

HW1K-2 A 11 - 1H -MAU

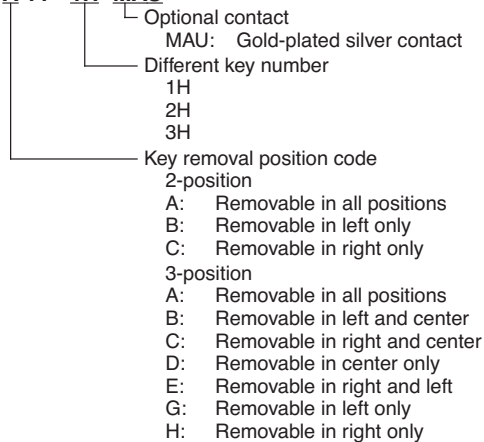

Note:

Key is not removable from spring-return positions.

Illuminated Selector Switches

HW1F-2 11 H 2 R -MAU

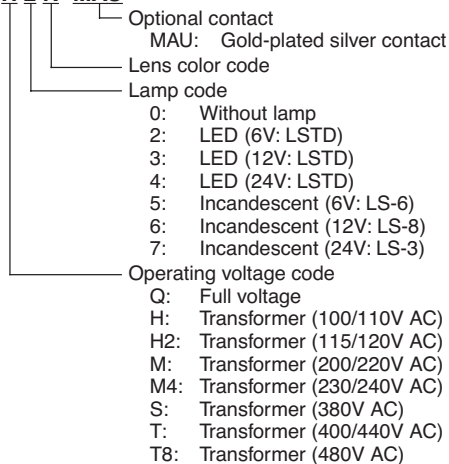

Note:

Full voltage type is not supplied with a lamp.

Transformer type contains an LED lamp (LSTD-6②) or incandescent lamp (LS-6).

Pushbutton Selectors

HW1R-2 D 22N1 B -MAU

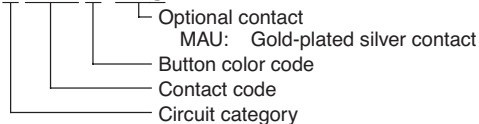

Mono-Lever Switches

HW1M - 1111 22N9 -MAU

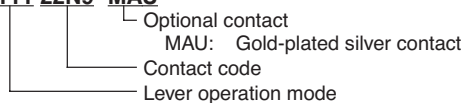

Emergency Stop Switches (Unibody Type) Specifications

Contact Ratings

Rated Insulation Voltage (Ui)		250V			
Rated Thermal Current (Ith)		10A			
Rated Operational Voltage (Ue)		24V	110V	220V	
Rated Operational Current	AC 50/60 Hz	Resistive Load (AC-12)	6A	3A	3A
		Inductive Load (AC-15)	6A	3A	3A
	DC	Resistive Load (DC-12)	6A	2A	1A
		Inductive Load (DC-13)	1.5A	0.3A	0.15A

Note: The operational current represents the classification by making and breaking currents (IEC 60947-5-1).
 Minimum applicable load (reference value): 3V AC/DC, 5 mA (Applicable range may vary with operating conditions and load types.)

LED Lamp Ratings

Unit Rated Operating Voltage	LED Lamp		
	Type No.	Rated Voltage	Rated Current
6V AC/DC	LSTD-6R	6V AC/DC ±10%	14 mA
12V AC/DC	LSTD-1R	12V AC/DC ±10%	10 mA
24V AC/DC	LSTD-2R	24V AC/DC ±10%	10 mA

Incandescent Lamp Ratings

Unit Rated Operating Voltage	Incandescent Lamp	
	Type No.	Wattage
6V AC/DC	LS-6	1W (6.3V)
12V AC/DC	LS-8	1W (18V)
24V AC/DC	LS-3	1W (30V)

Specifications

Operating Temperature	-25 to +60°C (no freezing) Illuminated units: -25 to +50°C
Storage Temperature	-40 to +80°C
Operating Humidity	45 to 85% RH (no condensation)
Contact Resistance	50 mΩ maximum (initial value)
Insulation Resistance	100 MΩ minimum (500V DC megger)
Dielectric Strength	Between live and dead metal parts
	Contacts: 2,500V AC, 1 minute Illuminated parts: 1,000V AC, 1 minute
Vibration Resistance	Damage limits: 60 m/s ²
	Operating extremes: 5 to 55 Hz, amplitude 0.5 mm
Shock Resistance	Damage limits: 1,000 m/s ²
	Operating extremes: 100 m/s ²
Operating Frequency	900 operations/h
Life	Mechanical: 250,000 operations minimum
	Electrical: 100,000 operations minimum (at 900 operations/h, duty ratio 40%)
Degree of Protection	IP65
Terminal Style	M3.5 screw

Applicable Standards and Approvals

Safety Standards	File No. or Organization
UL508	UL Listing File No. E55996
CSA C22.2 No. 14	c-UL (File No. E55996)
EN60947-5-5	DEMKO approved

Pushlock Turn Reset Switches (Unibody Type)

Shape	Contact	Type No.	Button Color
ø40mm Mushroom Pushlock Turn Reset HW1E-BV4 	1NO-1NC	HW1E-BV411R	Red only
	2NC	HW1E-BV402R	

- When pressed, the button is held depressed. The button is released by turning clockwise.
- Terminal cover HW-VL7 is supplied with the switch.

ø22 HW Series Emergency Stop Switches

Illuminated Pushlock Turn Reset Switches (Unibody Type)

Shape	Lamp	Contact	Type No.	Lens Color
ø40mm Mushroom Pushlock Turn Reset HW1E-LV4 	Without Lamp	1NO-1NC	HW1E-LV411Q0R	Red only
		2NC	HW1E-LV402Q0R	



- When pressed, the button is held depressed. The button is released by turning clockwise.
- The illuminated pushlock turn reset switch does not contain a lamp. Order LED or incandescent lamps separately. For lamps, see page 43.
- Terminal cover HW-VL7 is supplied with the switch.

Dimensions

• HW1E-BV4

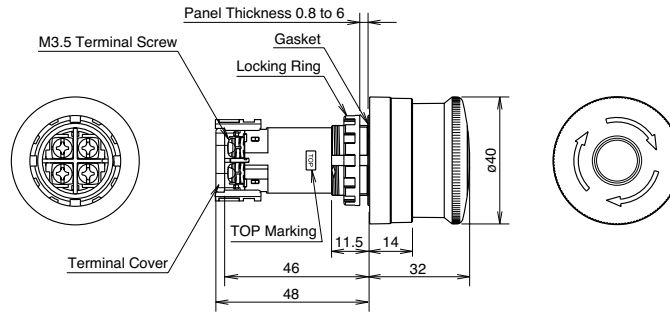

• HW1E-LV4

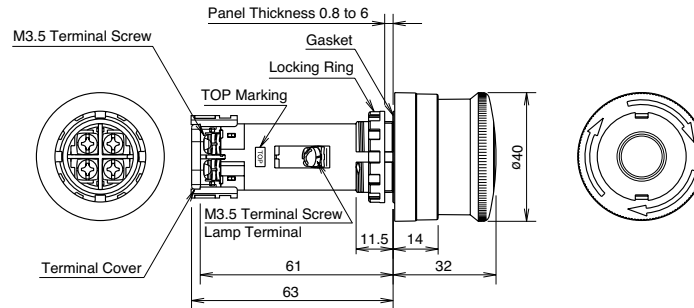

All dimensions in mm.

Mounting Hole

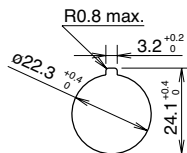

Determine the minimum mounting hole centers in consideration of convenience for wiring.

Terminal Arrangement (Bottom View)

• HW1E-BV4

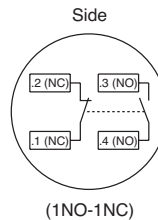

• HW1E-LV4

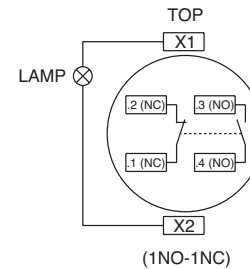

Replacement Parts

Name	Type No.	Ordering Type No.	Package Quantity	Remarks
Terminal Cover	HW-VL7	HW-VL7PN10	10	Used on HW1E emergency stop switches for preventing electrical shocks. The HW-VL7 terminal cover is supplied with the HW1E.

Emergency Stop Switches (Separate Type) Specifications

Contact Ratings

Contact Block	Rated Insulation Voltage	600V
	Rated Continuous Current	10A
	Contact Ratings by Utilization Category IEC 60947-5-1	AC-15 (A600) DC-13 (P600)

Characteristics

• Contact Ratings by Utilization Category

Operational Voltage		24V	48V	50V	110V	220V	440V	
Operational Current	AC 50/60 Hz	AC-12 Control of resistive loads and solid state loads	10A	—	10A	10A	6A	2A
		AC-15 Control of electromagnetic loads (> 72 VA)	10A	—	7A	5A	3A	1A
DC		DC-12 Control of resistive loads and solid state loads	8A	4A	—	2.2A	1.1A	—
		DC-13 Control of electromagnets	4A	2A	—	1.1A	0.6A	—







Applicable Standards and Approvals

Safety Standards	File No. or Organization
UL	UL Listing File No. E68961
CSA C22.2 No. 14	File No. LR92374
EN EN60947-1 EN60947-5-1	TÜV Rheinland R9551089

Specifications

Operating Temperature	–25 to +60°C (no freezing)
Storage Temperature	–40 to +80°C
Operating Humidity	45 to 85% RH (no condensation)
Contact Resistance	50 mΩ maximum (initial value)
Insulation Resistance	100 MΩ minimum (500V DC megger)
Dielectric Strength	Between live and dead metal parts Between terminals of different poles Between terminals of the same pole 2,500V AC, 1 minute
Vibration Resistance	Operating extremes: 5 to 55 Hz, amplitude 0.5 mm
Shock Resistance	Damage limits: 1,000 m/s ² Operating extremes: 100 m/s ²
Operating Frequency	900 operations/h
Life	Mechanical: 500,000 operations minimum (push-pull: 250,000 operations) Electrical: 500,000 operations minimum (push-pull: 250,000 operations) (at 900 operations/h, duty ratio 40%)
Degree of Protection	IP65
Terminal Style	M3.5 screw

Pushlock Turn Reset Switches (Separate Type)

Shape	Contact	Type No.	Button Color
ø29mm Mushroom Pushlock Turn Reset HW1B-V3  	1NC	HW1B-V301Ⓢ	Specify a button color code in place of Ⓢ in the Type No. R: red Y: yellow
	1NO-1NC	HW1B-V311Ⓢ	
	2NC	HW1B-V302Ⓢ	
	2NO-2NC	HW1B-V322Ⓢ	
ø40mm Mushroom Pushlock Turn Reset HW1B-V4  	1NC	HW1B-V401Ⓢ	
	1NO-1NC	HW1B-V411Ⓢ	
	2NC	HW1B-V402Ⓢ	
	2NO-2NC	HW1B-V422Ⓢ	
ø60mm Mushroom Pushlock Turn Reset HW1B-V5  	1NC	HW1B-V501Ⓢ	
	1NO-1NC	HW1B-V511Ⓢ	
	2NC	HW1B-V502Ⓢ	
	2NO-2NC	HW1B-V522Ⓢ	

- Yellow buttons cannot be used as emergency stop switches in compliance with EN standards.
- When pressed, the button is held depressed. The button is released by turning clockwise.
- Pushlock turn reset switches with one or three contact blocks contain a dummy block.
- Safety lever lock HW9Z-LS is supplied with the switch.
- Other contact arrangements and gold-plated silver contacts are also available. See page 7.

ø22 HW Series Emergency Stop Switches

Pushlock Key Reset Switches (Separate Type)

Shape	Contact	Type No.	Button Color
ø40mm Mushroom Pushlock Key Reset HW1B-X4 	1NC	HW1B-X401R	Red only
	1NO-1NC	HW1B-X411R	
	2NC	HW1B-X402R	
	2NO-2NC	HW1B-X422R	



- When pressed, the button is held depressed. The button is released by turning the key clockwise.
- Pushlock key reset switches with one or three contact blocks contain a dummy block.
- Two identical keys and safety lever lock HW9Z-LS are supplied with the switch.
- Other contact arrangements and gold-plated silver contacts are also available. See page 7.

Push-Pull Switches (Separate Type)

Shape	Contact	Type No.	Button Color
ø40mm Mushroom Push-Pull (2-position) HW1B-Y2 	1NC	HW1B-Y201①	Specify a button color code in place of ① in the Type No. R: red Y: yellow
	1NO-1NC	HW1B-Y211①	
	2NC	HW1B-Y202①	



- The button is maintained at either pulled or depressed position.
- Push-pull switches are available with one or two contact blocks.
- Push-pull switches with one contact block contain a dummy block.
- Safety lever lock HW9Z-LS is supplied with the switch.

Accessory

Nameplate

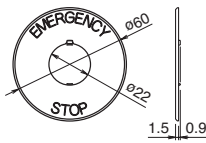
Shape	Name	Type No.	Legend	Package Quantity	Remarks
	Nameplate for Emergency Stop Switch	HWAV-0	(blank)	1	Background: Yellow Legend: Black Applicable panel thickness: 0.8 to 4.5 mm Material: Polyamide Not applicable for ø60mm mushroom buttons. Legend "EMERGENCY STOP" is indicated outside a ø44mm circle.
		HWAV-27	EMERGENCY STOP		

HW Series Emergency Stop Switches ø22

Dimensions

- ø29mm Pushlock Turn Reset
HW1B-V3

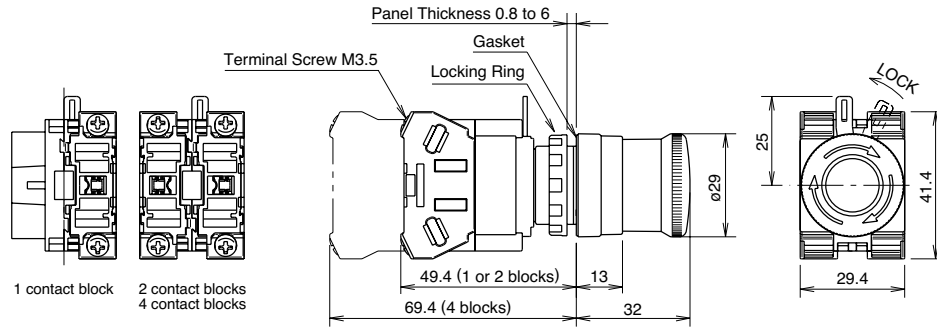

- ø40mm Pushlock Turn Reset
HW1B-V4

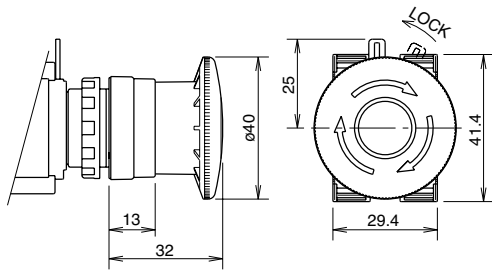

- ø60mm Pushlock Turn Reset
HW1B-V5

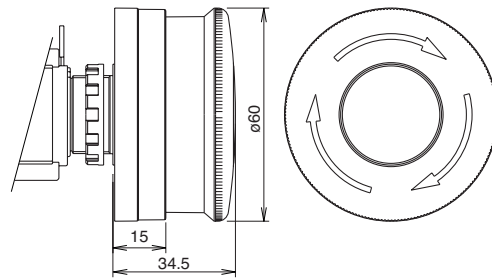

- ø40mm Pushlock Key Reset
HW1B-X4

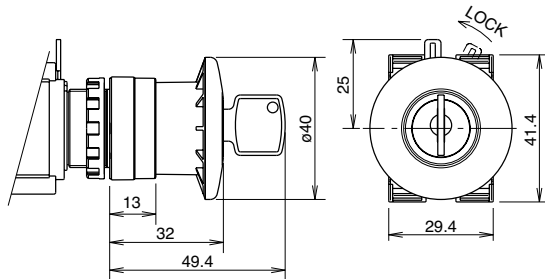

- ø40mm Push-Pull
HW1B-Y2

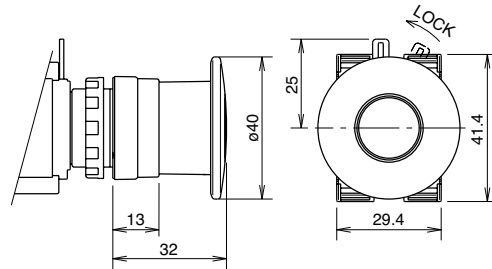

All dimensions in mm.

Mounting Hole

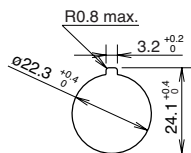

The minimum mounting centers shown below are applicable to emergency stop switches with one layer of contact blocks (two contact blocks). When two layers of contact blocks are mounted, determine the minimum mounting centers in consideration of convenience for wiring.









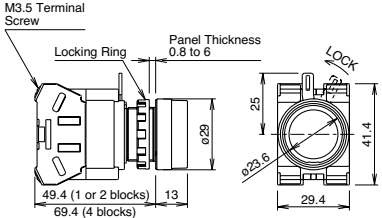

• Minimum Mounting Centers for Emergency Stop Switches

Unit	Vertical Spacing	Horizontal Spacing
HW1B-V3 HW1B-V4 HW1B-X4 HW1B-Y2	50 mm	50 mm
HW1B-V5	60 mm	60 mm

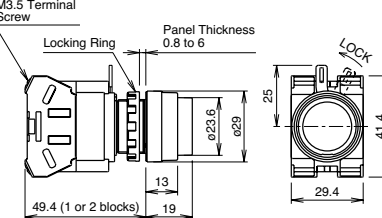
Note: When using the safety lever lock, determine the vertical spacing in consideration of convenience for installing and removing the safety lever lock.
Recommended vertical spacing: 100 mm

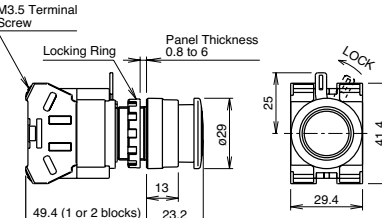
For emergency stop control boxes, see page 48.

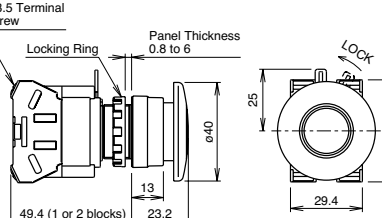

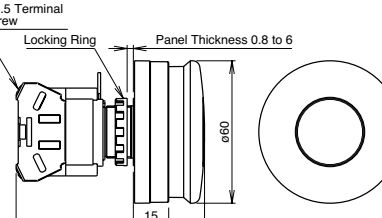

Flush / Extended / Mushroom Types

Shape	Operation Type	Contact	Type No.	① Button Color Code	Dimensions (mm)
Flush HW1B-M1 HW1B-A1  	Momentary	1NO	HW1B-M110①	Specify a button color code in place of ① in the Type No. B: black G: green R: red S: blue W: white Y: yellow	
		1NC	HW1B-M101①		
		1NO-1NC	HW1B-M111①		
		2NO	HW1B-M120①		
		2NC	HW1B-M102①		
		2NO-2NC	HW1B-M122①		
	Maintained	1NO	HW1B-A110①		
		1NC	HW1B-A101①		
		1NO-1NC	HW1B-A111①		
		2NO	HW1B-A120①		
		2NC	HW1B-A102①		
		2NO-2NC	HW1B-A122①		
Extended HW1B-M2 HW1B-A2  	Momentary	1NO	HW1B-M210①	Specify a button color code in place of ① in the Type No. B: black G: green R: red S: blue W: white Y: yellow	
		1NC	HW1B-M201①		
		1NO-1NC	HW1B-M211①		
		2NO	HW1B-M220①		
		2NC	HW1B-M202①		
		2NO-2NC	HW1B-M222①		
	Maintained	1NO	HW1B-A210①		
		1NC	HW1B-A201①		
		1NO-1NC	HW1B-A211①		
		2NO	HW1B-A220①		
		2NC	HW1B-A202①		
		2NO-2NC	HW1B-A222①		
ø29mm Mushroom HW1B-M3 HW1B-A3  	Momentary	1NO	HW1B-M310①	Specify a button color code in place of ① in the Type No. B: black G: green R: red S: blue W: white Y: yellow	
		1NC	HW1B-M301①		
		1NO-1NC	HW1B-M311①		
		2NO	HW1B-M320①		
		2NC	HW1B-M302①		
		2NO-2NC	HW1B-M322①		
	Maintained	1NO	HW1B-A310①		
		1NC	HW1B-A301①		
		1NO-1NC	HW1B-A311①		
		2NO	HW1B-A320①		
		2NC	HW1B-A302①		
		2NO-2NC	HW1B-A322①		
ø40mm Mushroom HW1B-M4 HW1B-A4  	Momentary	1NO	HW1B-M410①	Specify a button color code in place of ① in the Type No. B: black G: green R: red	
		1NC	HW1B-M401①		
		1NO-1NC	HW1B-M411①		
		2NO	HW1B-M420①		
		2NC	HW1B-M402①		
		2NO-2NC	HW1B-M422①		
	Maintained	1NO	HW1B-A410①		
		1NC	HW1B-A401①		
		1NO-1NC	HW1B-A411①		
		2NO	HW1B-A420①		
		2NC	HW1B-A402①		
		2NO-2NC	HW1B-A422①		
ø60mm Mushroom HW1B-M5  	Momentary	1NO	HW1B-M510①	Specify a button color code in place of ① in the Type No. B: black G: green R: red	
		1NC	HW1B-M501①		
		1NO-1NC	HW1B-M511①		
		2NO	HW1B-M520①		
		2NC	HW1B-M502①		
		2NO-2NC	HW1B-M522①		

- Pushbuttons with one or three contact blocks contain a dummy block.
- Other contact arrangements and gold-plated silver contacts are also available. See page 7.

ø22 HW Series Pushbuttons

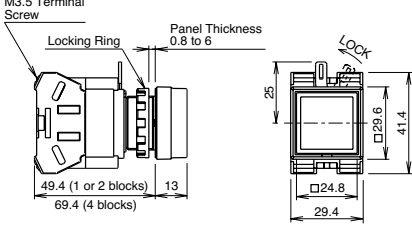
Square Flush / Square Extended Types

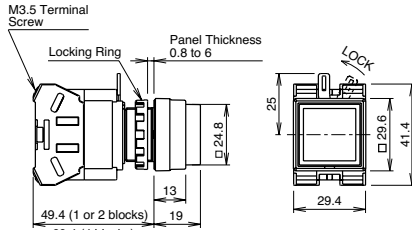
Shape	Operation Type	Contact	Type No.	① Button Color Code	Dimensions (mm)
Square Flush HW2B-M1 HW2B-A1  	Momentary	1NO	HW2B-M110①	Specify a button color code in place of ① in the Type No. B: black G: green R: red S: blue W: white Y: yellow	
		1NC	HW2B-M101①		
		1NO-1NC	HW2B-M111①		
		2NO	HW2B-M120①		
		2NC	HW2B-M102①		
	Maintained	1NO	HW2B-A110①		
		1NC	HW2B-A101①		
		1NO-1NC	HW2B-A111①		
		2NO	HW2B-A120①		
		2NC	HW2B-A102①		
Square Extended HW2B-M2 HW2B-A2  	Momentary	1NO	HW2B-M210①		
		1NC	HW2B-M201①		
		1NO-1NC	HW2B-M211①		
		2NO	HW2B-M220①		
		2NC	HW2B-M202①		
	Maintained	2NO-2NC	HW2B-M222①		
		1NO	HW2B-A210①		
		1NC	HW2B-A201①		
		1NO-1NC	HW2B-A211①		
		2NO	HW2B-A220①		
	2NC	HW2B-A202①			
	2NO-2NC	HW2B-A222①			

- Pushbuttons with one or three contact blocks contain a dummy block.
- Other contact arrangements and gold-plated silver contacts are also available. See page 7.

Contact Block (Bottom View)

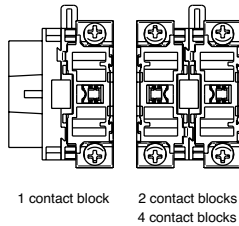





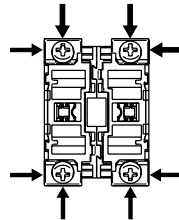

Terminal Wiring

- Arrows indicate access directions for wiring.

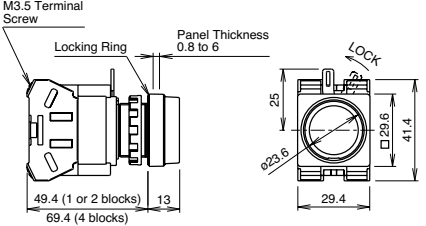

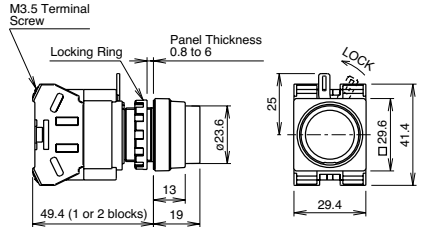
Round Button with Square Bezel Type

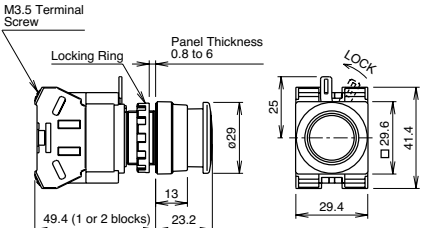
Shape	Operation Type	Contact	Type No.	① Button Color Code	Dimensions (mm)
Round Flush with Square Bezel HW3B-M1 HW3B-A1  	Momentary	1NO	HW3B-M110①	Specify a button color code in place of ① in the Type No. B: black G: green R: red S: blue W: white Y: yellow	
		1NC	HW3B-M101①		
		1NO-1NC	HW3B-M111①		
		2NO	HW3B-M120①		
		2NC	HW3B-M102①		
	Maintained	1NO	HW3B-A110①		
		1NC	HW3B-A101①		
		1NO-1NC	HW3B-A111①		
		2NO	HW3B-A120①		
		2NC	HW3B-A102①		
Round Extended with Square Bezel HW3B-M2 HW3B-A2  	Momentary	1NO	HW3B-M210①	Specify a button color code in place of ① in the Type No. B: black G: green R: red S: blue W: white Y: yellow	
		1NC	HW3B-M201①		
		1NO-1NC	HW3B-M211①		
		2NO	HW3B-M220①		
		2NC	HW3B-M202①		
	Maintained	2NO-2NC	HW3B-M222①		
		1NO	HW3B-A210①		
		1NC	HW3B-A201①		
		1NO-1NC	HW3B-A211①		
		2NO	HW3B-A220①		
ø29mm Mushroom with Square Bezel HW3B-M3 HW3B-A3  	Momentary	1NO	HW3B-M310①	Specify a button color code in place of ① in the Type No. B: black G: green R: red S: blue W: white Y: yellow	
		1NC	HW3B-M301①		
		1NO-1NC	HW3B-M311①		
		2NO	HW3B-M320①		
		2NC	HW3B-M302①		
	Maintained	2NO-2NC	HW3B-M322①		
		1NO	HW3B-A310①		
		1NC	HW3B-A301①		
		1NO-1NC	HW3B-A311①		
		2NO	HW3B-A320①		
	2NC	HW3B-A302①			
	2NO-2NC	HW3B-A322①			

- Pushbuttons with one or three contact blocks contain a dummy block.
- Other contact arrangements and gold-plated silver contacts are also available. See page 7.

Contact Block (Bottom View)

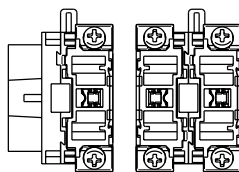

1 contact block 2 contact blocks
4 contact blocks





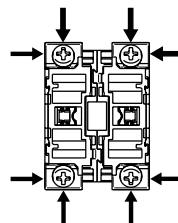

Terminal Wiring

- Arrows indicate access directions for wiring.



ø22 HW Series Pilot Lights

Round Flush / Dome / Square Flush Types

Shape	Lamp	Input Type	Type No.	② Lens/LED Color Code	③ Operating Voltage Code
Round Flush HW1P-1  (Photo: Full Voltage Type) 	Without Lamp	Full Voltage	HW1P-1Q0②	A: amber G: green PW: pure white R: red S: blue W: white Y: yellow	Specify an operating voltage code in place of ③ in the Type No. H: 100/110V AC H2: 115/120V AC M: 200/220V AC M4: 230/240V AC S: 380V AC T: 400/440V AC T8: 480V AC
	LED	Transformer	HW1P-1③2②		
		DC-DC Converter*	HW1P-1D2②		
	Incandescent	Transformer	HW1P-1③5②	A: amber G: green R: red S: blue W: white	
Dome HW1P-2  (Photo: Full Voltage Type) 	Without Lamp	Full Voltage	HW1P-2Q0②	A: amber G: green PW: pure white R: red S: blue W: white Y: yellow	
	LED	Transformer	HW1P-2③2②		
		DC-DC Converter*	HW1P-2D2②		
	Incandescent	Transformer	HW1P-2③5②	A: amber G: green R: red S: blue W: white	
Square Flush HW2P-1  (Photo: Transformer Type) 	Without Lamp	Full Voltage	HW2P-1Q0②	A: amber G: green PW: pure white R: red S: blue W: white Y: yellow	
	LED	Transformer	HW2P-1③2②		
		DC-DC Converter*	HW2P-1D2②		
	Incandescent	Transformer	HW2P-1③5②	A: amber G: green R: red S: blue W: white	

- Specify a lens/LED color code in place of ② in the Type No.
- Specify an operating voltage code in place of ③ in the Type No.
- Full voltage types do not contain a lamp. Order LED or incandescent lamps separately. For lamps, see page 43.
- LED illuminated transformer and DC-DC converter types contain an LED lamp (LSTD-6②, rated voltage 6V AC/DC).
- Incandescent illuminated transformer types contain an incandescent lamp (LS-6, rated voltage 6V AC/DC).
- * DC-DC converter types are not approved by UL, CSA, and TÜV, and not CE compliant (operating voltage 90 to 140V DC).

Dimensions

• Full Voltage Type

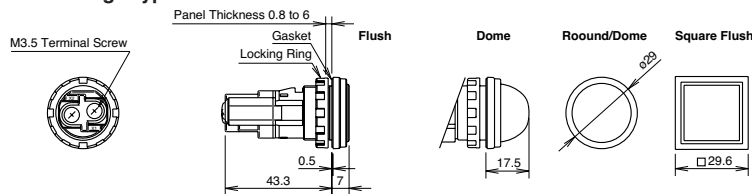

• Transformer Type

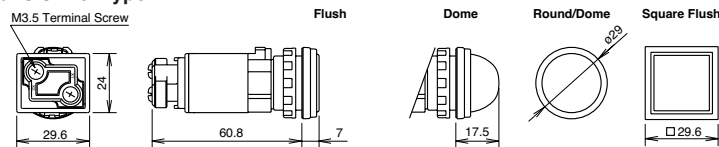

• DC-DC Converter Type

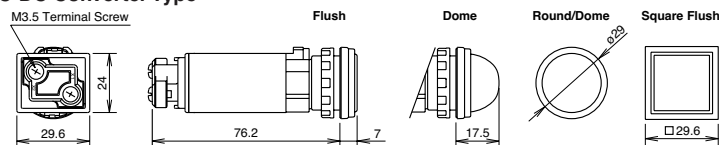

Mounting Hole Layout

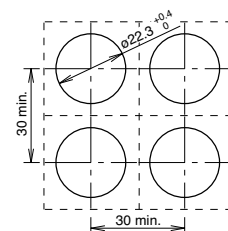

- Close mounting on 30mm centers
- Degree of protection: IP65



- When mounting transformer or DC-DC converter type units on 30mm centers vertically and horizontally, keep the ambient temperature below 40°C.

All dimensions in mm.

Round Flush Illuminated Pushbutton

Shape	Operation Type	Lamp	Input Type	Contact	Type No.		
 Round Flush HW1L-M1 HW1L-A1 	Momentary	Without Lamp	Full Voltage	1NO	HW1L-M110Q0②		
				1NC	HW1L-M101Q0②		
				1NO-1NC	HW1L-M111Q0②		
				2NO	HW1L-M120Q0②		
				2NC	HW1L-M102Q0②		
				2NO-2NC	HW1L-M122Q0②		
				1NO-1NC	HW1L-M111③2②		
		LED	Transformer	2NO	HW1L-M120③2②		
				2NC	HW1L-M102③2②		
				2NO-2NC	HW1L-M122③2②		
			DC-DC Converter*	1NO-1NC	HW1L-M111D2②		
				2NO	HW1L-M120D2②		
				2NC	HW1L-M102D2②		
				2NO-2NC	HW1L-M122D2②		
	Incandescent	Transformer	1NO-1NC	HW1L-M111③5②			
			2NO	HW1L-M120③5②			
			2NC	HW1L-M102③5②			
			2NO-2NC	HW1L-M122③5②			
			Maintained	Without Lamp	Full Voltage	1NO	HW1L-A110Q0②
						1NC	HW1L-A101Q0②
						1NO-1NC	HW1L-A111Q0②
	2NO	HW1L-A120Q0②					
	2NC	HW1L-A102Q0②					
	2NO-2NC	HW1L-A122Q0②					
	1NO-1NC	HW1L-A111③2②					
	LED	Transformer		2NO	HW1L-A120③2②		
				2NC	HW1L-A102③2②		
				2NO-2NC	HW1L-A122③2②		
DC-DC Converter*		1NO-1NC		HW1L-A111D2②			
		2NO		HW1L-A120D2②			
		2NC		HW1L-A102D2②			
		2NO-2NC		HW1L-A122D2②			
Incandescent	Transformer	1NO-1NC	HW1L-A111③5②				
		2NO	HW1L-A120③5②				
		2NC	HW1L-A102③5②				
		2NO-2NC	HW1L-A122③5②				



• Color Code and Operating Voltage Code

LED Illuminated Type	Incandescent Illuminated Type	③ Operating Voltage Code
② Lens/LED Color Code	② Lens Color Code	
Specify a lens/LED color code in place of ② in the Type No. A: amber G: green PW: pure white R: red S: blue W: white Y: yellow	Specify a lens color code in place of ② in the Type No. A: amber G: green R: red S: blue W: white	Specify an operating voltage code in place of ③ in the Type No. H: 100/110V AC H2: 115/120V AC M: 200/220V AC M4: 230/240V AC S: 380V AC T: 400/440V AC T8: 480V AC

Note: Full voltage types do not contain a lamp. Order LED or incandescent lamps separately. For lamps, see page 43.
 LED illuminated transformer and DC-DC converter types contain an LED lamp (LSTD-6②, rated voltage 6V AC/DC).
 Incandescent illuminated transformer types contain an incandescent lamp (LS-6, rated voltage 6V AC/DC).
 * DC-DC converter types are not approved by UL, CSA, and TÜV, and not CE compliant (operating voltage 90 to 140V DC).

ø22 HW Series Illuminated Pushbuttons

Round Extended Illuminated Pushbutton

Shape	Operation Type	Lamp	Input Type	Contact	Type No.		
Round Extended HW1L-M2 HW1L-A2  	Momentary	Without Lamp	Full Voltage	1NO	HW1L-M210Q0②		
				1NC	HW1L-M201Q0②		
				1NO-1NC	HW1L-M211Q0②		
				2NO	HW1L-M220Q0②		
				2NC	HW1L-M202Q0②		
				2NO-2NC	HW1L-M222Q0②		
		LED	Transformer	1NO-1NC	HW1L-M211③2②		
				2NO	HW1L-M220③2②		
				2NC	HW1L-M202③2②		
			DC-DC Converter*	2NO-2NC	HW1L-M222③2②		
				1NO-1NC	HW1L-M211D2②		
				2NO	HW1L-M220D2②		
		Incandescent	Transformer	2NC	HW1L-M202③5②		
				2NO-2NC	HW1L-M222③5②		
				1NO-1NC	HW1L-M211③5②		
			Maintained	Without Lamp	Full Voltage	2NO	HW1L-M220③5②
						2NC	HW1L-M202③5②
						2NO-2NC	HW1L-M222③5②
	1NO	HW1L-A210Q0②					
	1NC	HW1L-A201Q0②					
	1NO-1NC	HW1L-A211Q0②					
	LED	Transformer		2NO	HW1L-A220③2②		
				2NC	HW1L-A202③2②		
				2NO-2NC	HW1L-A222③2②		
		DC-DC Converter*		1NO-1NC	HW1L-A211D2②		
				2NO	HW1L-A220D2②		
				2NC	HW1L-A202D2②		
	Incandescent	Transformer	2NO-2NC	HW1L-A222D2②			
			1NO-1NC	HW1L-A211③5②			
			2NO	HW1L-A220③5②			
2NC		HW1L-A202③5②					
2NO-2NC		HW1L-A222③5②					
2NO-2NC		HW1L-A222③5②					

• Color Code and Operating Voltage Code

LED Illuminated Type	Incandescent Illuminated Type	③ Operating Voltage Code
② Lens/LED Color Code	② Lens Color Code	
Specify a lens/LED color code in place of ② in the Type No.	Specify a lens color code in place of ② in the Type No.	Specify an operating voltage code in place of ③ in the Type No.
A: amber G: green PW: pure white R: red S: blue W: white Y: yellow	A: amber G: green R: red S: blue W: white	H: 100/110V AC H2: 115/120V AC M: 200/220V AC M4: 230/240V AC S: 380V AC T: 400/440V AC T8: 480V AC

Note: Full voltage types do not contain a lamp. Order LED or incandescent lamps separately. For lamps, see page 43.

LED illuminated transformer and DC-DC converter types contain an LED lamp (LSTD-6②, rated voltage 6V AC/DC).

Incandescent illuminated transformer types contain an incandescent lamp (LS-6, rated voltage 6V AC/DC).

* DC-DC converter types are not approved by UL, CSA, and TÜV, and not CE compliant (operating voltage 90 to 140V DC).

Round Extended with Full Shroud Illuminated Pushbutton

Shape	Operation Type	Lamp	Input Type	Contact	Type No.
	Momentary	Without Lamp	Full Voltage	1NO	HW1L-MF210Q②
				1NC	HW1L-MF201Q②
				1NO-1NC	HW1L-MF211Q②
				2NO	HW1L-MF220Q②
				2NC	HW1L-MF202Q②
				2NO-2NC	HW1L-MF222Q②
		LED	Transformer	1NO-1NC	HW1L-MF211③②
				2NO	HW1L-MF220③②
				2NC	HW1L-MF202③②
			DC-DC Converter*	2NO-2NC	HW1L-MF222③②
				1NO-1NC	HW1L-MF211D②
				2NO	HW1L-MF220D②
		Incandescent	Transformer	2NC	HW1L-MF202③②
				2NO-2NC	HW1L-MF222③②
				1NO-1NC	HW1L-MF211③⑤②
	Full Voltage		2NO	HW1L-MF220③⑤②	
			2NC	HW1L-MF202③⑤②	
			2NO-2NC	HW1L-MF222③⑤②	
	Maintained	Without Lamp	Full Voltage	1NO	HW1L-AF210Q②
				1NC	HW1L-AF201Q②
				1NO-1NC	HW1L-AF211Q②
				2NO	HW1L-AF220Q②
				2NC	HW1L-AF202Q②
				2NO-2NC	HW1L-AF222Q②
		LED	Transformer	1NO-1NC	HW1L-AF211③②
				2NO	HW1L-AF220③②
				2NC	HW1L-AF202③②
			DC-DC Converter*	2NO-2NC	HW1L-AF222③②
				1NO-1NC	HW1L-AF211D②
				2NO	HW1L-AF220D②
Incandescent		Transformer	2NC	HW1L-AF202③②	
			2NO-2NC	HW1L-AF222③②	
			1NO-1NC	HW1L-AF211③⑤②	
	Full Voltage	2NO	HW1L-AF220③⑤②		
		2NC	HW1L-AF202③⑤②		
		2NO-2NC	HW1L-AF222③⑤②		



• Color Code and Operating Voltage Code

LED Illuminated Type	Incandescent Illuminated Type	③ Operating Voltage Code
② Lens/LED Color Code	② Lens Color Code	
Specify a lens/LED color code in place of ② in the Type No. A: amber G: green PW: pure white R: red S: blue W: white Y: yellow	Specify a lens color code in place of ② in the Type No. A: amber G: green R: red S: blue W: white	Specify an operating voltage code in place of ③ in the Type No. H: 100/110V AC H2: 115/120V AC M: 200/220V AC M4: 230/240V AC S: 380V AC T: 400/440V AC T8: 480V AC

Note: Full voltage types do not contain a lamp. Order LED or incandescent lamps separately. For lamps, see page 43.
 LED illuminated transformer and DC-DC converter types contain an LED lamp (LSTD-6②, rated voltage 6V AC/DC).
 Incandescent illuminated transformer types contain an incandescent lamp (LS-6, rated voltage 6V AC/DC).
 * DC-DC converter types are not approved by UL, CSA, and TÜV, and not CE compliant (operating voltage 90 to 140V DC).

ø22 HW Series Illuminated Pushbuttons

Square Flush Illuminated Pushbutton

Shape	Operation Type	Lamp	Input Type	Contact	Type No.
Square Flush HW2L-M1 HW2L-A1  	Momentary	Without Lamp	Full Voltage	1NO	HW2L-M110Q0②
				1NC	HW2L-M101Q0②
				1NO-1NC	HW2L-M111Q0②
				2NO	HW2L-M120Q0②
				2NC	HW2L-M102Q0②
				2NO-2NC	HW2L-M122Q0②
		LED	Transformer	1NO-1NC	HW2L-M111③2②
				2NO	HW2L-M120③2②
				2NC	HW2L-M102③2②
			DC-DC Converter*	2NO-2NC	HW2L-M122③2②
				1NO-1NC	HW2L-M111D2②
				2NO	HW2L-M120D2②
				2NC	HW2L-M102D2②
				2NO-2NC	HW2L-M122D2②
				Incandescent	Transformer
	2NO	HW2L-M120③5②			
	2NC	HW2L-M102③5②			
	Maintained	Without Lamp	Full Voltage	1NO	HW2L-A110Q0②
				1NC	HW2L-A101Q0②
				1NO-1NC	HW2L-A111Q0②
				2NO	HW2L-A120Q0②
				2NC	HW2L-A102Q0②
				2NO-2NC	HW2L-A122Q0②
		LED	Transformer	1NO-1NC	HW2L-A111③2②
				2NO	HW2L-A120③2②
				2NC	HW2L-A102③2②
			DC-DC Converter*	2NO-2NC	HW2L-A122③2②
				1NO-1NC	HW2L-A111D2②
				2NO	HW2L-A120D2②
				2NC	HW2L-A102D2②
2NO-2NC				HW2L-A122D2②	
Incandescent				Transformer	1NO-1NC
	2NO	HW2L-A120③5②			
	2NC	HW2L-A102③5②			
				2NO-2NC	HW2L-A122③5②

• Color Code and Operating Voltage Code

LED Illuminated Type	Incandescent Illuminated Type	③ Operating Voltage Code
② Lens/LED Color Code	② Lens Color Code	
Specify a lens/LED color code in place of ② in the Type No.	Specify a lens color code in place of ② in the Type No.	Specify an operating voltage code in place of ③ in the Type No.
A: amber G: green PW: pure white R: red S: blue W: white Y: yellow	A: amber G: green R: red S: blue W: white	H: 100/110V AC H2: 115/120V AC M: 200/220V AC M4: 230/240V AC S: 380V AC T: 400/440V AC T8: 480V AC



Note: Full voltage types do not contain a lamp. Order LED or incandescent lamps separately. For lamps, see page 43.

LED illuminated transformer and DC-DC converter types contain an LED lamp (LSTD-6②, rated voltage 6V AC/DC).

Incandescent illuminated transformer types contain an incandescent lamp (LS-6, rated voltage 6V AC/DC).

* DC-DC converter types are not approved by UL, CSA, and TÜV, and not CE compliant (operating voltage 90 to 140V DC).

Round Flush with Square Bezel Illuminated Pushbutton

Shape	Operation Type	Lamp	Input Type	Contact	Type No.	
 Round Flush with Square Bezel HW3L-M1 HW3L-A1 	Momentary	Without Lamp	Full Voltage	1NO	HW3L-M110Q0②	
				1NC	HW3L-M101Q0②	
				1NO-1NC	HW3L-M111Q0②	
				2NO	HW3L-M120Q0②	
				2NC	HW3L-M102Q0②	
				2NO-2NC	HW3L-M122Q0②	
		LED	Transformer	1NO-1NC	HW3L-M111③2②	
				2NO	HW3L-M120③2②	
				2NC	HW3L-M102③2②	
			DC-DC Converter*	2NO-2NC	HW3L-M122③2②	
				1NO-1NC	HW3L-M111D2②	
				2NO	HW3L-M120D2②	
	Incandescent	Transformer	2NC	HW3L-M102③5②		
			2NO-2NC	HW3L-M122③5②		
			1NO-1NC	HW3L-M111③5②		
		Maintained	Without Lamp	Full Voltage	2NO	HW3L-M120③5②
					1NO	HW3L-A110Q0②
					1NC	HW3L-A101Q0②
	1NO-1NC				HW3L-A111Q0②	
	2NO				HW3L-A120Q0②	
	2NC				HW3L-A102Q0②	
	LED	Transformer	Full Voltage	2NO-2NC	HW3L-A122Q0②	
				1NO-1NC	HW3L-A111③2②	
				2NO	HW3L-A120③2②	
2NC				HW3L-A102③2②		
2NO-2NC				HW3L-A122③2②		
1NO-1NC				HW3L-A111D2②		
DC-DC Converter*		2NO	HW3L-A120D2②			
		2NC	HW3L-A102D2②			
		2NO-2NC	HW3L-A122D2②			
		1NO-1NC	HW3L-A111③5②			
		2NO	HW3L-A120③5②			
		2NC	HW3L-A102③5②			
Incandescent	Transformer	Full Voltage	2NO-2NC	HW3L-A122③5②		
			2NO	HW3L-A120③5②		
			2NC	HW3L-A102③5②		
			1NO-1NC	HW3L-A111③5②		

• Color Code and Operating Voltage Code

LED Illuminated Type	Incandescent Illuminated Type	③ Operating Voltage Code
② Lens/LED Color Code	② Lens Color Code	
Specify a lens/LED color code in place of ② in the Type No. A: amber G: green PW: pure white R: red S: blue W: white Y: yellow	Specify a lens color code in place of ② in the Type No. A: amber G: green R: red S: blue W: white	Specify an operating voltage code in place of ③ in the Type No. H: 100/110V AC H2: 115/120V AC M: 200/220V AC M4: 230/240V AC S: 380V AC T: 400/440V AC T8: 480V AC

Note: Full voltage types do not contain a lamp. Order LED or incandescent lamps separately. For lamps, see page 43.



LED illuminated transformer and DC-DC converter types contain an LED lamp (LSTD-6②, rated voltage 6V AC/DC).

Incandescent illuminated transformer types contain an incandescent lamp (LS-6, rated voltage 6V AC/DC).

* DC-DC converter types are not approved by UL, CSA, and TÜV, and not CE compliant (operating voltage 90 to 140V DC).

ø22 HW Series Illuminated Pushbuttons

Mushroom (ø29mm) Illuminated Pushbutton

Shape	Operation Type	Lamp	Input Type	Contact	Type No.
ø29mm Mushroom HW1L-M3 HW1L-A3  	Momentary	Without Lamp	Full Voltage	1NO	HW1L-M310Q0②
				1NC	HW1L-M301Q0②
				1NO-1NC	HW1L-M311Q0②
				2NO	HW1L-M320Q0②
				2NC	HW1L-M302Q0②
				2NO-2NC	HW1L-M322Q0②
		LED	Transformer	1NO-1NC	HW1L-M311③2②
				2NO	HW1L-M320③2②
				2NC	HW1L-M302③2②
			DC-DC Converter*	2NO-2NC	HW1L-M322③2②
				1NO-1NC	HW1L-M311D2②
				2NO	HW1L-M320D2②
				2NC	HW1L-M302D2②
				2NO-2NC	HW1L-M322D2②
				Incandescent	Transformer
	2NO	HW1L-M320③5②			
	2NC	HW1L-M302③5②			
	Maintained	Without Lamp	Full Voltage	1NO	HW1L-A310Q0②
				1NC	HW1L-A301Q0②
				1NO-1NC	HW1L-A311Q0②
				2NO	HW1L-A320Q0②
				2NC	HW1L-A302Q0②
				2NO-2NC	HW1L-A322Q0②
		LED	Transformer	1NO-1NC	HW1L-A311③2②
				2NO	HW1L-A320③2②
				2NC	HW1L-A302③2②
			DC-DC Converter*	2NO-2NC	HW1L-A322③2②
				1NO-1NC	HW1L-A311D2②
				2NO	HW1L-A320D2②
				2NC	HW1L-A302D2②
2NO-2NC				HW1L-A322D2②	
Incandescent				Transformer	1NO-1NC
	2NO	HW1L-A320③5②			
	2NC	HW1L-A302③5②			
2NO-2NC	HW1L-A322③5②				

• Color Code and Operating Voltage Code

LED Illuminated Type	Incandescent Illuminated Type	③ Operating Voltage Code
② Lens/LED Color Code	② Lens Color Code	
Specify a lens/LED color code in place of ② in the Type No.	Specify a lens color code in place of ② in the Type No.	Specify an operating voltage code in place of ③ in the Type No.
A: amber G: green PW: pure white R: red S: blue W: white Y: yellow	A: amber G: green R: red S: blue W: white	H: 100/110V AC H2: 115/120V AC M: 200/220V AC M4: 230/240V AC S: 380V AC T: 400/440V AC T8: 480V AC





Note: Full voltage types do not contain a lamp. Order LED or incandescent lamps separately. For lamps, see page 43.

LED illuminated transformer and DC-DC converter types contain an LED lamp (LSTD-6②, rated voltage 6V AC/DC).

Incandescent illuminated transformer types contain an incandescent lamp (LS-6, rated voltage 6V AC/DC).

* DC-DC converter types are not approved by UL, CSA, and TÜV, and not CE compliant (operating voltage 90 to 140V DC).

Mushroom (ø29mm) with Square Bezel Illuminated Pushbutton

Shape	Operation Type	Lamp	Input Type	Contact	Type No.		
<div style="display: flex; flex-direction: column; align-items: center;">  <div style="display: flex; gap: 5px; margin-top: 10px;">     </div> </div>	Momentary	Without Lamp	Full Voltage	1NO	HW3L-M310Q0②		
				1NC	HW3L-M301Q0②		
				1NO-1NC	HW3L-M311Q0②		
				2NO	HW3L-M320Q0②		
				2NC	HW3L-M302Q0②		
				2NO-2NC	HW3L-M322Q0②		
				1NO-1NC	HW3L-M311③2②		
		LED	Transformer	2NO	HW3L-M320③2②		
				2NC	HW3L-M302③2②		
				2NO-2NC	HW3L-M322③2②		
			DC-DC Converter*	1NO-1NC	HW3L-M311D2②		
				2NO	HW3L-M320D2②		
				2NC	HW3L-M302D2②		
				2NO-2NC	HW3L-M322D2②		
	Incandescent	Transformer	1NO-1NC	HW3L-M311③5②			
			2NO	HW3L-M320③5②			
			2NC	HW3L-M302③5②			
			2NO-2NC	HW3L-M322③5②			
			Maintained	Without Lamp	Full Voltage	1NO	HW3L-A310Q0②
						1NC	HW3L-A301Q0②
						1NO-1NC	HW3L-A311Q0②
	2NO	HW3L-A320Q0②					
	2NC	HW3L-A302Q0②					
	2NO-2NC	HW3L-A322Q0②					
	1NO-1NC	HW3L-A311③2②					
	LED	Transformer		2NO	HW3L-A320③2②		
				2NC	HW3L-A302③2②		
				2NO-2NC	HW3L-A322③2②		
DC-DC Converter*		1NO-1NC		HW3L-A311D2②			
		2NO		HW3L-A320D2②			
		2NC		HW3L-A302D2②			
		2NO-2NC		HW3L-A322D2②			
Incandescent	Transformer	1NO-1NC	HW3L-A311③5②				
		2NO	HW3L-A320③5②				
		2NC	HW3L-A302③5②				
		2NO-2NC	HW3L-A322③5②				



• Color Code and Operating Voltage Code

LED Illuminated Type	Incandescent Illuminated Type	③ Operating Voltage Code
② Lens/LED Color Code	② Lens Color Code	
Specify a lens/LED color code in place of ② in the Type No. A: amber G: green PW: pure white R: red S: blue W: white Y: yellow	Specify a lens color code in place of ② in the Type No. A: amber G: green R: red S: blue W: white	Specify an operating voltage code in place of ③ in the Type No. H: 100/110V AC H2: 115/120V AC M: 200/220V AC M4: 230/240V AC S: 380V AC T: 400/440V AC T8: 480V AC

Note: Full voltage types do not contain a lamp. Order LED or incandescent lamps separately. For lamps, see page 43.
 LED illuminated transformer and DC-DC converter types contain an LED lamp (LSTD-6②, rated voltage 6V AC/DC).
 Incandescent illuminated transformer types contain an incandescent lamp (LS-6, rated voltage 6V AC/DC).
 * DC-DC converter types are not approved by UL, CSA, and TÜV, and not CE compliant (operating voltage 90 to 140V DC).

ø22 HW Series Illuminated Pushbuttons

Mushroom (ø40mm) Illuminated Pushbutton

Shape	Operation Type	Lamp	Input Type	Contact	Type No.	
ø40mm Mushroom HW1L-M4 HW1L-A4  	Momentary	Without Lamp	Full Voltage	1NO	HW1L-M410Q0②	
				1NC	HW1L-M401Q0②	
				1NO-1NC	HW1L-M411Q0②	
				2NO	HW1L-M420Q0②	
				2NC	HW1L-M402Q0②	
				2NO-2NC	HW1L-M422Q0②	
		LED	Transformer	1NO-1NC	HW1L-M411③2②	
				2NO	HW1L-M420③2②	
				2NC	HW1L-M402③2②	
			DC-DC Converter*	2NO-2NC	HW1L-M422③2②	
				1NO-1NC	HW1L-M411D2②	
				2NO	HW1L-M420D2②	
	Incandescent	Transformer	2NC	HW1L-M402③5②		
			2NO-2NC	HW1L-M422③5②		
			1NO-1NC	HW1L-M411③5②		
		Maintained	Without Lamp	Full Voltage	2NO	HW1L-M420③5②
					1NO	HW1L-A410Q0②
					1NC	HW1L-A401Q0②
	1NO-1NC				HW1L-A411Q0②	
	2NO				HW1L-A420Q0②	
	2NC				HW1L-A402Q0②	
	LED		Transformer	2NO-2NC	HW1L-A422Q0②	
				1NO-1NC	HW1L-A411③2②	
				2NO	HW1L-A420③2②	
			DC-DC Converter*	2NC	HW1L-A402③2②	
				2NO-2NC	HW1L-A422③2②	
				1NO-1NC	HW1L-A411D2②	
	Incandescent	Transformer	2NO	HW1L-A420③5②		
2NC			HW1L-A402③5②			
1NO-1NC			HW1L-A411③5②			
2NO		HW1L-A420D2②				
2NC		HW1L-A402D2②				
2NO-2NC		HW1L-A422D2②				

• Color Code and Operating Voltage Code

LED Illuminated Type	Incandescent Illuminated Type	③ Operating Voltage Code
② Lens/LED Color Code	② Lens Color Code	
Specify a lens/LED color code in place of ② in the Type No.	Specify a lens color code in place of ② in the Type No.	Specify an operating voltage code in place of ③ in the Type No.
A: amber G: green PW: pure white R: red S: blue W: white Y: yellow	A: amber G: green R: red S: blue W: white	H: 100/110V AC H2: 115/120V AC M: 200/220V AC M4: 230/240V AC S: 380V AC T: 400/440V AC T8: 480V AC

Note: Full voltage types do not contain a lamp. Order LED or incandescent lamps separately. For lamps, see page 43.

LED illuminated transformer and DC-DC converter types contain an LED lamp (LSTD-6②, rated voltage 6V AC/DC).

Incandescent illuminated transformer types contain an incandescent lamp (LS-6, rated voltage 6V AC/DC).

* DC-DC converter types are not approved by UL, CSA, and TÜV, and not CE compliant (operating voltage 90 to 140V DC).

Dimensions

• Full Voltage Type

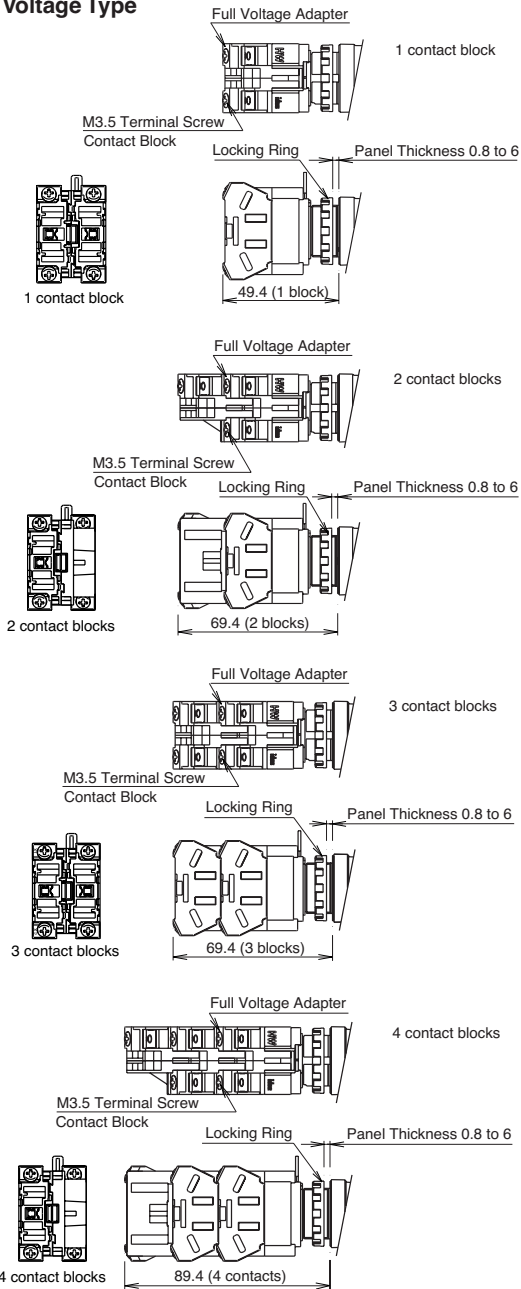

• Transformer Type

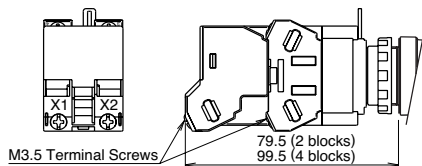

• DC-DC Converter Type

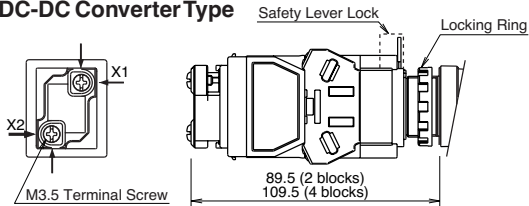

• Operator

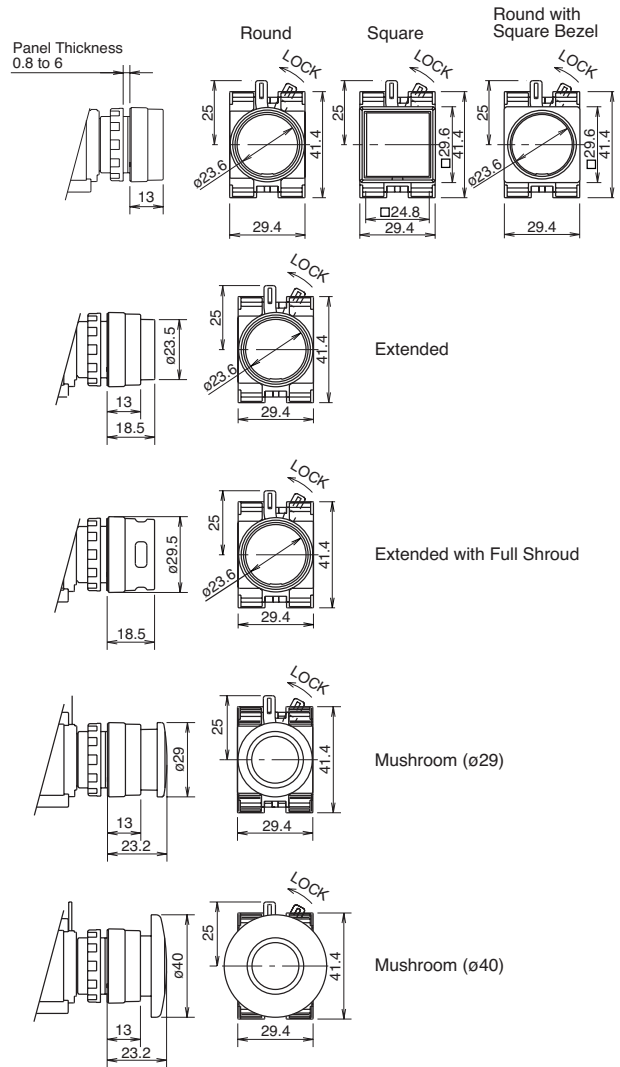





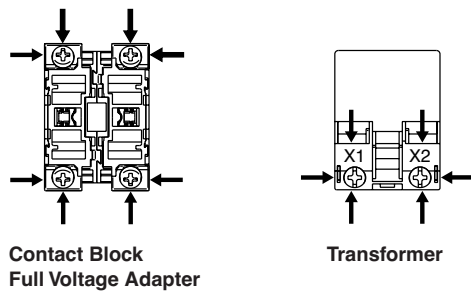





Terminal Wiring

• Arrows indicate access directions for wiring.



ø22 HW Series Selector Switches

Selector Switches





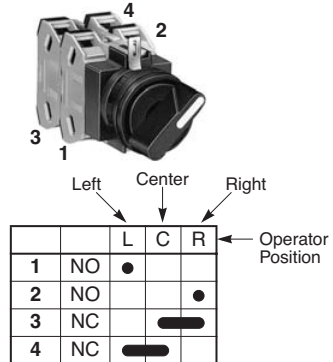



No. of Positions	Shape				HW1S				Dimensions on page 32.				
	Contact Arrangement Chart				Maintained (90°)	Spring Return from Right (60°)							
90° 2-position / 60° 2-position	Contact Code	Contact Block		Operator Position				—	—				
		Mounting Position	Type	L	R								
	10 (1NO)	1	NO		●	HW1S-2T10	HW1S-21T10	—	—				
		2	Dummy										
	11 (1NO-1NC)	1	NO		●					HW1S-2T11	HW1S-21T11	—	—
		2	NC	●									
	20 (2NO)	1	NO		●					HW1S-2T20	HW1S-21T20	—	—
		2	NO		●								
	22 (2NO-2NC)	1	NO		●					HW1S-2T22	HW1S-21T22	—	—
		2	NC	●									
3	NO		●										
4	NC	●											
45° 3-position	Contact Code	Contact Block		Operator Position									
		Mounting Position	Type	L	C	R							
	20 (2NO)	1	NO	●		●	HW1S-3T20	HW1S-31T20	HW1S-32T20	HW1S-33T20			
		2	NO			●							
	02 (2NC)	1	NC		■		HW1S-3T02	HW1S-31T02	HW1S-32T02	HW1S-33T02			
		2	NC		■								
	22N1 (2NO-2NC)	1	NO	●		●	HW1S-3T22N1	HW1S-31T22N1	HW1S-32T22N1	HW1S-33T22N1			
		2	NO			●							
		3	NC		■								
		4	NC		■								
	22N9 ★ (2NO-2NC)	1	NC		■	●	HW1S-3ST22N9	—	—	—			
		2	NC	●									
		3	NO		■								
		4	NO			●							
	40 (4NO)	1	NO	●		●	HW1S-3T40	HW1S-31T40	HW1S-32T40	HW1S-33T40			
		2	NO			●							
		3	NO	●									
		4	NO			●							
	40N2 ★ (4NO)	1	NO	●		●	HW1S-3ST40N2	—	—	—			
		2	NO		■								
		3	NO	●									
		4	NO			●							
	04 (4NC)	1	NC		■		HW1S-3T04	HW1S-31T04	HW1S-32T04	HW1S-33T04			
		2	NC		■								
		3	NC		■								
		4	NC		■								
	21N1 ★ (2NO-1NC)	1	NO	●		●	HW1S-3JT21N1	—	—	—			
		2	NO			●							
3		NC		■									
4		Dummy											
30° 5-position / 45° 4-position	Contact Code	Contact Block		Operator Position							• Contact Block Mounting Position and Contact Arrangement Chart		
		Mounting Position	Type	1	2	3	4	5					
	13N6 ★ (1NO-3NC)	1	NC		■					HW1S-4T13N6	—		
		2	NC	●									
		3	NC			■							
		4	NO				●						
	22N3 ★ (2NO-2NC)	1	NO	●						HW1S-4T22N3	—		
		2	NC		■								
		3	NC			■							
		4	NO				●						
	12 ★ (1NO-2NC)	1	NO	●						HW1S-4T12	—		
		2	NC		■								
3		NC			■								
4		Dummy											
22N3 ★ (2NO-2NC)	1	NO	●						—	HW1S-5T22N3			
	2	NC		■									
	3	NC			■								
	4	NO				●							

• Contact Block Mounting Position and Contact Arrangement Chart



- On the contact arrangement marked with ★ in the table above, the rated current (load switching current) is reduced to a half of the rated current of the contact block. The rated insulation voltage and the rated thermal current remain unchanged.
- Selector switches with one or three contact blocks contain a dummy block. Knob operator: White indicator on black body
- Other contact arrangements are also available. See pages 33 through 36.

Key Selector Switches

No. of Positions	Shape				HW1K			Dimensions on page 32.		
	Contact Arrangement Chart									
90° 2-position / 60° 2-position	Contact Code	Contact Block		Operator Position		Maintained (90°)	Spring Return from Right (60°)	—	—	
		Mounting Position	Type	L	R					
	10 (1NO)	1	NO		●		HW1K-2A10	HW1K-21B10	—	—
		2	Dummy							
	11 (1NO-1NC)	1	NO		●		HW1K-2A11	HW1K-21B11	—	—
		2	NC	●						
	20 (2NO)	1	NO		●		HW1K-2A20	HW1K-21B20	—	—
		2	NO		●					
	22 (2NO-2NC)	1	NO		●		HW1K-2A22	HW1K-21B22	—	—
		2	NC	●						
3		NO		●						
	4	NC	●							
45° 3-position	Contact Code	Contact Block		Operator Position			Maintained	Spring Return from Right	Spring Return from Left	Spring Return Two-way
		Mounting Position	Type	L	C	R				
	20 (2NO)	1	NO	●			HW1K-3A20	HW1K-31B20	HW1K-32C20	HW1K-33D20
		2	NO			●				
	02 (2NC)	1	NC			●	HW1K-3A02	HW1K-31B02	HW1K-32C02	HW1K-33D02
		2	NC			●				
	22N1 (2NO-2NC)	1	NO	●			HW1K-3A22N1	HW1K-31B22N1	HW1K-32C22N1	HW1K-33D22N1
		2	NO			●				
		3	NC			●				
		4	NC			●				
	22N9 ★ (2NO-2NC)	1	NC			●	HW1K-3SA22N9	—	—	—
		2	NC	●						
		3	NO			●				
		4	NO			●				
	40 (4NO)	1	NO	●			HW1K-3A40	HW1K-31B40	HW1K-32C40	HW1K-33D40
		2	NO			●				
		3	NO	●						
		4	NO			●				
	40N2 ★ (4NO)	1	NO	●			HW1K-3SA40N2	—	—	—
		2	NO			●				
		3	NO	●						
		4	NO			●				
	04 (4NC)	1	NC			●	HW1K-3A04	HW1K-31B04	HW1K-32C04	HW1K-33D04
		2	NC			●				
		3	NC			●				
		4	NC			●				
	21N1 ★ (2NO-1NC)	1	NO	●			HW1K-3JA21N1	—	—	—
		2	NO			●				
3		NC			●					
4		Dummy								

- On the spring-returned types, the key can be released only from the maintained position. On the maintained types, the key can be released from every position. Key retained positions are also available. See page 8.
- Each key selector switch is supplied with two identical keys. Three different keys are also available. See page 8.
- On the contact arrangement marked with ★ in the table above, the rated current (load switching current) is reduced to a half of the rated current of the contact block. The rated insulation voltage and the rated thermal current remain unchanged.
- Key selector switches with one or three contact blocks contain a dummy block.
- Cylinder cover: black, Cylinder: metal
- Other contact arrangements are also available. See pages 33 through 36.



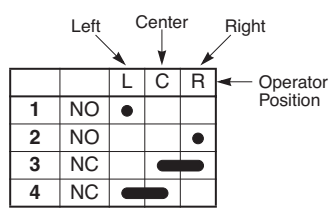

• **Contact Block Mounting Position and Contact Arrangement Chart**



ø22 HW Series Illuminated Selector Switches

Illuminated Selector Switches

90° 2-position / 60° 2-position

Shape		HW1F							
Contact Arrangement Chart				Dimensions on page 32.					
Contact Code	Contact Block		Operator Position		Lamp	Input Type	Maintained (90°)	Spring Return from Right (60°)	
	Mounting Position	Type	L	R					
11 (1NO-1NC)	1	NO		●	Without Lamp	Full Voltage	HW1F-211Q0②	HW1F-2111Q0②	
	2	NC	●		LED	Transformer	HW1F-211③2②	HW1F-2111③2②	
					Incandescent	Transformer	HW1F-211③5②	HW1F-2111③5②	
20 (2NO)	1	NO		●	Without Lamp	Full Voltage	HW1F-220Q0②	HW1F-2120Q0②	
	2	NO		●	LED	Transformer	HW1F-220③2②	HW1F-2120③2②	
					Incandescent	Transformer	HW1F-220③5②	HW1F-2120③5②	
22 (2NO-2NC)	1	NO		●	Without Lamp	Full Voltage	HW1F-222Q0②	HW1F-2122Q0②	
	2	NC	●						
	3	NO		●	LED	Transformer	HW1F-222③2②	HW1F-2122③2②	
	4	NC	●						
				Incandescent	Transformer	HW1F-222③5②	HW1F-2122③5②		

• Color Code and Operating Voltage Code

LED Illuminated Type	Incandescent Illuminated Type	③ Operating Voltage Code
② Lens/LED Color Code	② Lens Color Code	
Specify a lens/LED color code in place of ② in the Type No.	Specify a lens color code in place of ② in the Type No.	Specify an operating voltage code in place of ③ in the Type No.
A: amber G: green R: red S: blue W: white Y: yellow	A: amber G: green R: red S: blue W: white	H: 100/110V AC H2: 115/120V AC M: 200/220V AC M4: 230/240V AC S: 380V AC T: 400/440V AC T8: 480V AC

- Full voltage types do not contain a lamp. Order LED or incandescent lamps separately. For lamps, see page 43.
- LED illuminated transformer types contain an LED lamp (LSTD-6②, rated voltage 6V AC/DC).
- Incandescent illuminated transformer types contain an incandescent lamp (LS-6, rated voltage 6V AC/DC).

• Contact Block Mounting Position and Contact Arrangement Chart

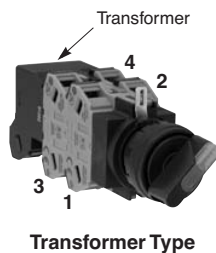
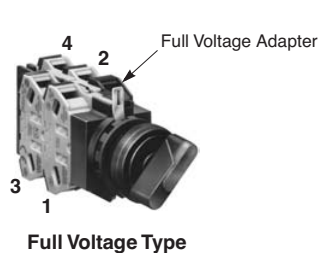

		Left	Right	
		L	R	← Operator Position
1	NO		●	
2	NC	●		
3	NO		●	
4	NC	●		

For more contact arrangement chart, see page 33.

HW Series Illuminated Selector Switches ø22

45° 3-position

Contact Code	Contact Block		Operator Position			Lamp Input Type	Maintained	Spring Return from Right	Spring Return from Left	Spring Return Two-way
	Mounting Position	Type	L	C	R					
20 (2NO)	1	NO	●			Without Lamp Full Voltage	HW1F-320Q0②	HW1F-3120Q0②	HW1F-3220Q0②	HW1F-3320Q0②
	2	NO			●	LED Transformer	HW1F-320③2②	HW1F-3120③2②	HW1F-3220③2②	HW1F-3320③2②
						Incandescent Transformer	HW1F-320③5②	HW1F-3120③5②	HW1F-3220③5②	HW1F-3320③5②
02 (2NC)	1	NC		■		Without Lamp Full Voltage	HW1F-302Q0②	HW1F-3102Q0②	HW1F-3202Q0②	HW1F-3302Q0②
	2	NC		■		LED Transformer	HW1F-302③2②	HW1F-3102③2②	HW1F-3202③2②	HW1F-3302③2②
						Incandescent Transformer	HW1F-302③5②	HW1F-3102③5②	HW1F-3202③5②	HW1F-3302③5②
22N1 (2NO-2NC)	1	NO	●			Without Lamp Full Voltage	HW1F-322N1Q0②	HW1F-3122N1Q0②	HW1F-3222N1Q0②	HW1F-3322N1Q0②
	2	NO			●					
	3	NC		■		LED Transformer	HW1F-322N1③2②	HW1F-3122N1③2②	HW1F-3222N1③2②	HW1F-3322N1③2②
	4	NC		■						
					Incandescent Transformer	HW1F-322N1③5②	HW1F-3122N1③5②	HW1F-3222N1③5②	HW1F-3322N1③5②	
40 (4NO)	1	NO	●			Without Lamp Full Voltage	HW1F-340Q0②	HW1F-3140Q0②	HW1F-3240Q0②	HW1F-3340Q0②
	2	NO			●					
	3	NO	●			LED Transformer	HW1F-340③2②	HW1F-3140③2②	HW1F-3240③2②	HW1F-3340③2②
	4	NO			●					
					Incandescent Transformer	HW1F-340③5②	HW1F-3140③5②	HW1F-3240③5②	HW1F-3340③5②	
04 (4NC)	1	NC		■		Without Lamp Full Voltage	HW1F-304Q0②	HW1F-3104Q0②	HW1F-3204Q0②	HW1F-3304Q0②
	2	NC		■						
	3	NC		■		LED Transformer	HW1F-304③2②	HW1F-3104③2②	HW1F-3204③2②	HW1F-3304③2②
	4	NC		■						
					Incandescent Transformer	HW1F-304③5②	HW1F-3104③5②	HW1F-3204③5②	HW1F-3304③5②	

• Color Code and Operating Voltage Code

LED Illuminated Type	Incandescent Illuminated Type	③ Operating Voltage Code
② Lens/LED Color Code	② Lens Color Code	
Specify a lens/LED color code in place of ② in the Type No. A: amber G: green R: red S: blue W: white Y: yellow	Specify a lens color code in place of ② in the Type No. A: amber G: green R: red S: blue W: white	Specify an operating voltage code in place of ③ in the Type No. H: 100/110V AC H2: 115/120V AC M: 200/220V AC M4: 230/240V AC S: 380V AC T: 400/440V AC T8: 480V AC

- Full voltage types do not contain a lamp. Order LED or incandescent lamps separately. For lamps, see page 43.
- LED illuminated transformer types contain an LED lamp (LSTD-6②, rated voltage 6V AC/DC).
- Incandescent illuminated transformer types contain an incandescent lamp (LS-6, rated voltage 6V AC/DC).

• Contact Block Mounting Position and Contact Arrangement Chart

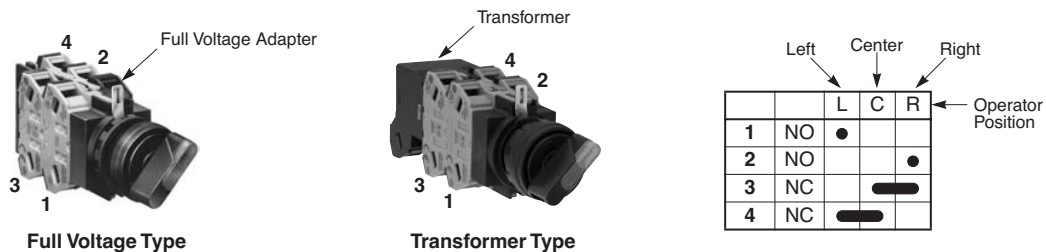

For more contact arrangement chart, see page 33.

ø22 HW Series Selector Switches

Dimensions: Selector Switches

• Knob Operator

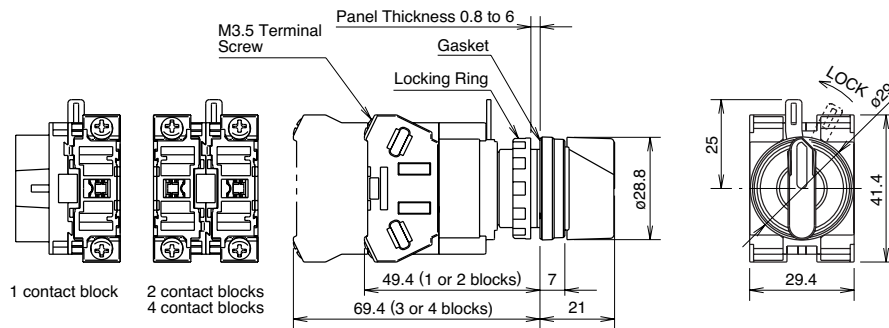

• Key Operator

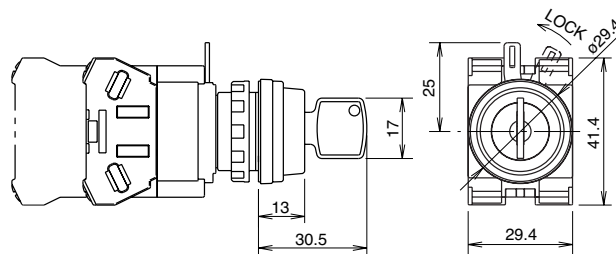

Dimensions: Illuminated Selector Switches

• Full Voltage Type

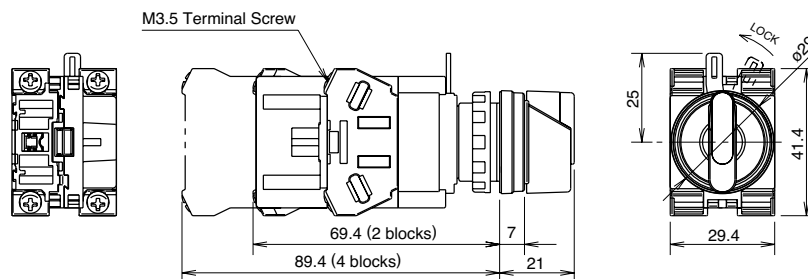

• Transformer Type

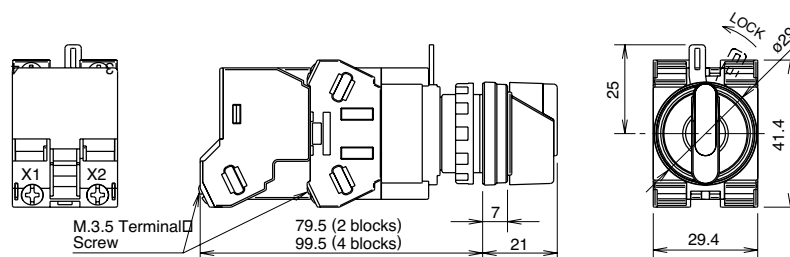

All dimensions in mm.

Terminal Wiring

• Arrows indicate access directions for wiring.

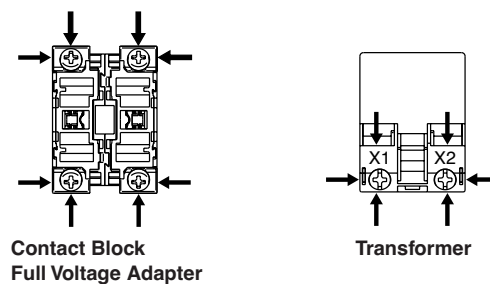

HW Series Selector Switch Contact Arrangement Charts ø22

90° 2-position (Maintained) / 60° 2-position (Spring Return)

Contact Code	Contact Block		Operator Position		Operator Availability					Cam Code	Remarks	
					L		R		L			R
	Mounting Position	Type	L	C	Knob	Key	Illuminated	Knob	Key			Illuminated
10 (1NO)	1	NO		●								Standard
	2	Dummy			x	x	x	x	x	x	—	
01 (1NC)	1	NC	●									
	2	Dummy			x	x	x	x	—	x	—	
11 (1NO-1NC)	1	NO		●								Standard
	2	NC	●		x	x	x	x	x	x	—	
11N1 (1NO-1NC)	1	NC	●									
	2	NO		●	x	x	x	x	—	x	—	
20 (2NO)	1	NO		●								Standard
	2	NO		●	x	x	x	x	x	x	—	
02 (2NC)	1	NC	●									
	2	NC	●		x	x	x	x	—	x	—	
22 (2NO-2NC)	1	NO		●								Standard
	2	NO	●		x	x	x	x	x	x	—	
	3	NC		●								
	4	NC	●									
22N2 (2NO-2NC)	1	NC	●									
	2	NO		●	x	x	x	x	—	x	—	
	3	NC	●									
	4	NO		●								
22N1 (2NO-2NC)	1	NO		●								
	2	NO		●	x	x	x	x	—	x	—	
	3	NC	●									
	4	NC	●									
22N4 (2NO-2NC)	1	NC	●									
	2	NO		●	x	x	x	x	—	x	—	
	3	NO		●								
	4	NC	●									
31N1 (3NO-1NC)	1	NC	●									
	2	NO		●	x	x	x	x	—	x	—	
	3	NO		●								
	4	NO		●								
40 (4NO)	1	NO		●								
	2	NO		●	x	x	x	x	—	x	—	
	3	NO		●								
	4	NO		●								
7S ★ (1NO-1NC)	1	NO		■								
	2	NC	■		x	x	x	x	—	x	—	
8S ★ (2NO-2NC)	1	NO		■								
	2	NC	■		x	x	x	x	—	x	—	
	3	NO		■								
	4	NC	■									
22N7 ★ (2NO-2NC)	1	NC	■									
	2	NO		■	x	x	x	x	—	x	—	
	3	NC	■									
	4	NO		■								

• On the contact arrangement marked with ★ in the table above, the rated current (load switching current) is reduced to a half of the rated current of the contact block. The rated insulation voltage and the rated thermal current remain unchanged.

Remarks: When ordering the contact arrangement indicated with "Standard" in the table above, specify the Type No. shown in the standard Type No. on preceding pages. For other contact arrangements, see page 36 to specify the Type No. and contact code.

ø22 HW Series Selector Switch Contact Arrangement Charts

45° 3-position

Contact Code	Contact Block		Operator Position			Operator Availability												Cam Code	Remarks	
						L			C			R			L					C
	Mounting Position	Type	L	C	R	Knob	Key	Illuminated	Knob	Key	Illuminated	Knob	Key	Illuminated	Knob	Key	Illuminated			
11 (1NO-1NC)	1	NO	●			x	x	x	x	x	x	x	x	x	x	x	x	x		
	2	NC	■																	
11N1 (1NO-1NC)	1	NC		■		x	x	x	x	x	x	x	x	x	x	x	x	x		
	2	NO			●															
7S ★ (1NO-1NC)	1	NO	●		●	x	x	x										J		
	2	NC	■																	
11N1 ★ (1NO-1NC)	1	NC		●		x	x	x										J		
	2	NO			●															
20 (2NO)	1	NO	●			x	x	x	x	x	x	x	x	x	x	x	x	x	Standard	
	2	NO			●															
1S ★ (2NO)	1	NO	●			x	x	x										J		
	2	NO			●															
2S ★ (2NC)	1	NC		●		x	x	x										J		
	2	NC	■																	
02 (2NC)	1	NC		■		x	x	x	x	x	x	x	x	x	x	x	x	x	Standard	
	2	NC	■																	
22N1 (2NO-2NC)	1	NO	●																	
	2	NO			●	x	x	x	x	x	x	x	x	x	x	x	x	x	Standard	
	3	NC		■																
	4	NC	■																	
22N2 (2NO-2NC)	1	NC		■																
	2	NO			●	x	x	x	x	x	x	x	x	x	x	x	x	x		
	3	NC		■																
	4	NO			●															
8S ★ (2NO-2NC)	1	NO	●		●	x	x	x										J		
	2	NC	■																	
	3	NO	●		●															
	4	NC	■																	
22N8 ★ (2NO-2NC)	1	NO	●		●															
	2	NC	■			x	x	x										J		
	3	NC		●																
	4	NO			●															
22N2 ★ (2NO-2NC)	1	NC		●																
	2	NO			●	x	x	x										J		
	3	NC		●																
	4	NO			●															
31 (3NO-1NC)	1	NO	●																	
	2	NC	■			x	x	x	x	x	x	x	x	x	x	x	x	x		
	3	NO	●																	
	4	NO			●															
31N1 (3NO-1NC)	1	NC		■																
	2	NO			●	x	x	x	x	x	x	x	x	x	x	x	x	x		
	3	NO	●																	
	4	NO			●															
13 (1NO-3NC)	1	NO	●																	
	2	NC	■			x	x	x	x	x	x	x	x	x	x	x	x	x		
	3	NC		■																
	4	NC	■																	
13N3 ★ (1NO-3NC)	1	NC		●																
	2	NO			●	x	x	x										J		
	3	NC		●																
	4	NC	■																	

Remarks: When ordering the contact arrangement indicated with "Standard" in the table above, specify the Type No. shown in the standard Type No. on preceding pages. For other contact arrangements, see page 36 to specify the Type No. and contact code.

ø22 HW Series Selector Switch Contact Arrangement Charts

45° 4-position

Contact Code	Contact Block		Operator Position				Operator Availability	Cam Code	Remarks
			1	2	3	4	Knob		
12 ★ (1NO-2NC)	1	NO	●				x	—	Standard
	2	NC		●					
	3	NC			●				
	4	Dummy							
04N3 ★ (4NC)	1	NC		■■■■			x	—	
	2	NC		●					
	3	NC			●				
	4	NC	■■■■						
13N6 ★ (1NO-3NC)	1	NC		■■■■			x	—	Standard
	2	NC		●					
	3	NC			●				
	4	NO				●			
13N5 ★ (1NO-3NC)	1	NO	●				x	—	
	2	NC		●					
	3	NC			●				
	4	NC	■■■■						
22N3 ★ (2NO-2NC)	1	NO	●				x	—	Standard
	2	NC		●					
	3	NC			●				
	4	NO				●			

30° 5-position

Contact Code	Contact Block		Operator Position					Operator Availability	Cam Code	Remarks
			1	2	3	4	5	Knob		
22N3 ★ (2NO-2NC)	1	NO	●					x	—	Standard
	2	NC		●						
	3	NC				●				
	4	NO					●			

• Contact Block Mounting Position and Contact Arrangement Chart

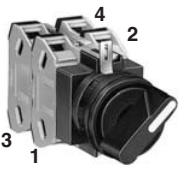

Non-illuminated Selector

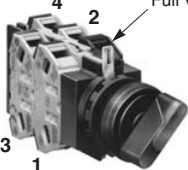

Illuminated Selector Full Voltage Type

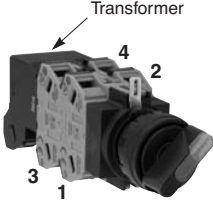

Illuminated Selector Transformer Type

		Left	Center	Right	
		L	C	R	← Operator Position
1	NO	●			
2	NO			●	
3	NC		■■■■		
4	NC	■■■■			

Type No. Development

• When cam code is not required

HW1S - 2 T 11

- Contact code (1NO-1NC)
- "T" for knob operator
- 2-position

• When cam code is required

HW1K - 3 J A 22N2

- Contact code (2NO-2NC)
- Key removal option code
- Cam code (J, S, or none)
- 3-position

Pushbutton Selectors

Shape	Circuit Category	Contact Code	Contact Block						Type No.	① Button Color Code
			Mounting Position	Type	Normal	Depressed	Normal	Depressed		
 	A	11 (1NO-1NC)	1	NO		●		●	HW1R-2A11①	Specify a button color code in place of ① in the Type No. B: black G: green R: red S: blue W: white Y: yellow
			2	NC	●					
		20 (2NO)	1	NO		●		●	HW1R-2A20①	
			2	NO		●	■			
		22 (2NO-2NC)	1	NO		●		●	HW1R-2A22①	
			2	NC	●					
	3		NO		●		●			
	D	20 (2NO)	1	NO		●		●	HW1R-2D20①	
			2	NO		●		●		
		22N1 (2NO-2NC)	1	NO		●		●	HW1R-2D22N1①	
			2	NO		●		●		
	E	22N1 ★ (2NO-2NC)	3	NC	●		■		HW1R-2E22N1①	
			4	NC	●		■			
			1	NO		●		●		
			2	NO		●		●		
	F	22N1 ★ (2NO-2NC)	3	NC			■		HW1R-2F22N1①	
			4	NC	●					
			1	NO		●		●		
			2	NO		●		●		
	N	22N2 ★ (2NO-2NC)	3	NC			■		HW1R-2N22N2①	
4			NO		●		●			
1			NC			●				
2			NO		●		●			
T	22N1 ★ (2NO-2NC)	3	NC	●			Blocked	HW1R-2T22N1①		
		4	NC	●						
		1	NO		●	●				
		2	NO		●	●				

- On the contact arrangement marked with ★ in the table above, the rated current (load switching current) is reduced to a half of the rated current of the contact block. The rated insulation voltage and the rated thermal current remain unchanged.
- When operating the pushbutton selector, do not turn the operator ring or the lock lever while the button is depressed. Otherwise the pushbutton selector may be damaged.
- Other contact arrangements are also available upon request.

Dimensions

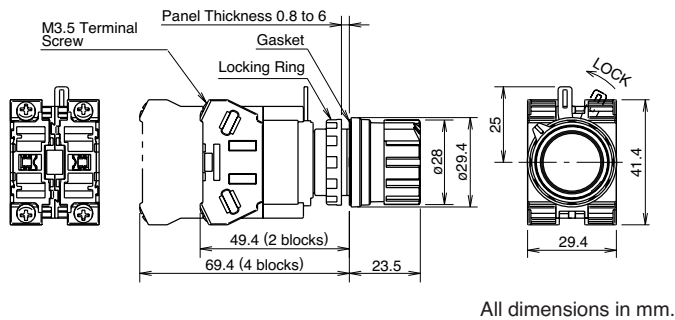



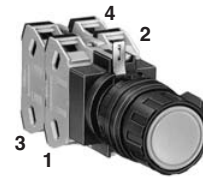

• Contact Block Mounting Position and Contact Arrangement Chart



Contact Block	Left		Right		Ring Position	Button
	Normal	Depressed	Normal	Depressed		
1	NO					
2	NO	●				
3	NC		●			
4	NC	●				

ø22 HW Series Mono-Lever Switches

Mono-Lever Switches

Shape	Positions	Type No.
HW1M Standard Lever  	2-position	HW1M-1010-20
		HW1M-2020-20
		HW1M-0101-20
		HW1M-0202-20
		HW1M-0101-40
	4-position	HW1M-1111-22N9
HW1M-2222-22N9		
HW1M-L Interlocking Lever  	2-position	HW1M-L1010-20
		HW1M-L2020-20
		HW1M-L0101-20
		HW1M-L0202-20
		HW1M-L0101-40
	4-position	HW1M-L1111-22N9
		HW1M-L2222-22N9
		HW1M-L2222-22N9

• On all mono-lever switches, the rated current (load switching current) is reduced to a half of the rated current of the contact block. The rated insulation voltage and the rated thermal current remain unchanged.

Contact Arrangement Chart

• 2-position (Right/Left)

Contact Code	Contact Block		Lever Operator Position		
	Mounting Position	Type	Left	Center	Right
20	1	NO	●		
	2	NO			●
40	1	NO	●		
	2	NO			●
	3	NO	●		
	4	NO			●

• 2-position (Up/Down)

Contact Code	Contact Block		Lever Operator Position		
	Mounting Position	Type	Down	Center	Up
20	1	NO	●		
	2	NO			●
40	1	NO	●		
	2	NO			●
	3	NO	●		
	4	NO			●

• 4-position

Contact Code	Contact Block		Lever Operator Position				
	Mounting Position	Type	Down	Left	Center	Up	Right
22N9	1	NC					●
	2	NC	●				
	3	NO		●			
	4	NO				●	

Ordering Information

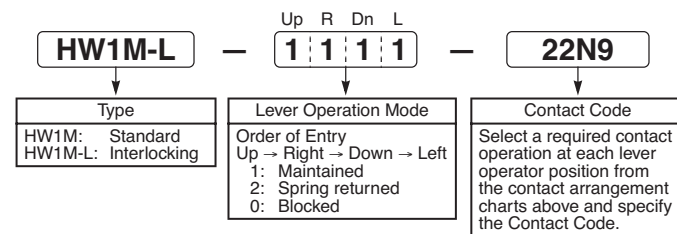

• Contact Block Mounting Position and Lever Operator Position

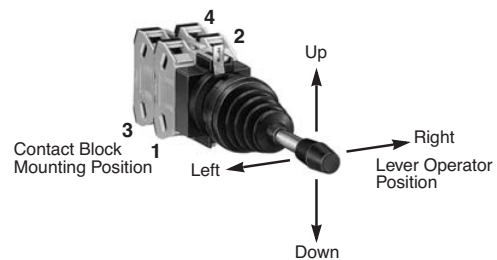

• The lever operator of the interlocking type HW1M-L is locked only in the center position.

Dimensions

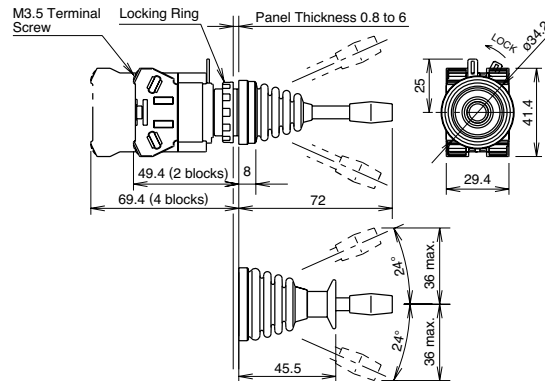

All dimensions in mm.

Accessories

Nameplates

• HWAM, HWAQ, HWAS, and HWAV

Description	Legend	Material	Type No.	Ordering Type No.	Package Quantity	Dimensions (mm)
HWAM	Order marking plate separately.	Plastic (black) 1.5 mm thick	HWAM	HWAM	1	
				HWAMPN10	10	
HWAQ	Order marking plate separately.	Plastic (black) 1.5 mm thick	HWAQ	HWAQ	1	
				HWAQPN10	10	
HWAS	Blank	Plastic (black) 1.5 mm thick	HWAS-0	HWAS-0	1	
				HWAS-0PN10	10	
HWAV	Blank	Plastic (yellow) 1.5 mm thick	HWAV-0	HWAV-0	1	
	EMERGENCY STOP		HWAV-27	HWAV-27	1	

• Making Plate

Description	Material	Type No.	Ordering Type No.	Package Quantity	Dimensions (mm)
HWNP	Aluminum (black) 1.0 mm thick	HWNP-*	HWNP-*	1	<p>• White legend on black background.</p>
			HWNP-*PN10	10	

• Specify a legend code in place of * in the Ordering Type No.

Legends

Code	Legend
0	(blank)
1	ON
2	OFF
3	START
4	STOP
31	OFF-ON
35	HAND-AUTO
53	HAND-OFF-AUTO

• Installing the marking plate on a nameplate

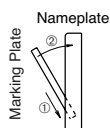



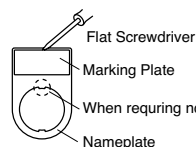







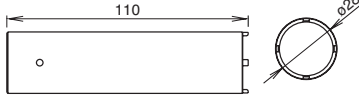

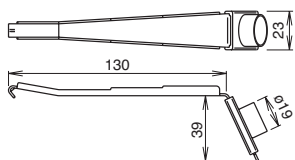

• To remove the marking plate, insert the flat screwdriver between the marking plate and nameplate.

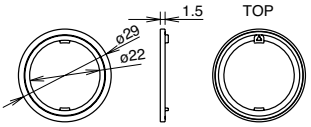

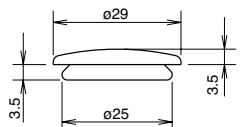
Note: When using an nameplate, the mounting panel thickness is decreased by 1.5 mm.

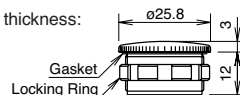
ø22 HW Series Accessories and Replacement Parts

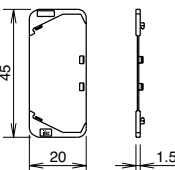
Accessories

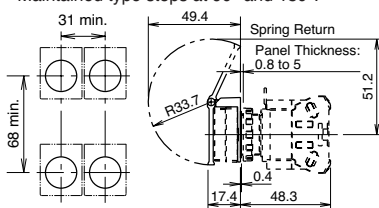
Shape	Material	Type No.	Ordering Type No.	Package Quantity	Dimensions (mm)
	Metal (weight: approx. 150g)	MW9Z-T1	MW9Z-T1	1	<ul style="list-style-type: none"> Used to tighten the locking ring when installing the HW switch onto a panel. Tighten the locking ring to a torque of 2.0 N·m. 
	Rubber	OR-55	OR-55	1	<ul style="list-style-type: none"> Used to install and remove the LED/incandescent lamps. 
	Metal/Rubber	TW-KC1	TW-KC1	1	<ul style="list-style-type: none"> Used to remove the contact block and transformer, and also to install/remove the pilot light and illuminated pushbutton lens. 
	Plastic	HW9Z-RL	HW9Z-RLPN10	10	<ul style="list-style-type: none"> Used to prevent the operator from turning. Generally used when using no nameplates on selector switches and pushbutton selectors. 
	Rubber (black)	OB-31	OB-31PN05	5	<ul style="list-style-type: none"> Used to plug the unused ø22.2mm mounting holes. 
	Diecast Metal (locking ring: plastic)	LW9Z-BM	LW9Z-BM	1	<ul style="list-style-type: none"> Used to plug the unused ø22.2mm mounting holes. Tighten the locking ring to a torque of 1.2 N·m. IP66 Mounting panel thickness: 0.8 to 6 mm 
	Plastic	HW-VG1	HW-VG1PN10	10	<ul style="list-style-type: none"> Used to prevent contact between adjacent lead wires when units are mounted closely. Barriers should always be used in close mounting. 
	Spring Return	HW9Z-K1	HW9Z-K1	1	<ul style="list-style-type: none"> Used to prevent inadvertent operation for flush pushbuttons and illuminated pushbuttons. IP65 Maintained type stops at 90° and 180°. 
	Maintained	HW9Z-K11	HW9Z-K11	1	

Accessories					
Shape	Material	Type No.	Ordering Type No.	Package Quantity	Dimensions (mm)
Pushbutton Clear Boot 	For flush pushbuttons	Rubber (EPDM)	OC-31	OC-31	1
	For extended pushbuttons		OC-32	OC-32	1
Padlock cover 	Polyarylate (gasket: nitril rubber)	HW9Z-KL1	HW9Z-KL1	1	• Used to protect pushbuttons, illuminated pushbuttons, selector switches, and key selector switches.
Ring Adapter 		HW9Z-A25	HW9Z-A25PN05	5	• Used to install the HW/TW units into ø25 mounting holes. • IP65 • Cannot be used with anti-rotation ring and nameplate. • Mounting panel thickness: 1.2 to 6.0 mm
Ring Adapter 		HW9Z-A30	HW9Z-A30PN02	2	• Used to install the HW units into ø30 mounting holes (except for HW1E and HW1B-M5/V5). • IP65 • Cannot be used with anti-rotation ring, nameplate, full-shroud illuminated pushbuttons, pushbutton selectors, and mono-lever switches. • Mounting panel thickness: 1.6 to 4.0 mm
Ring Adapter 		HW9Z-A30E	HW9Z-A30EPN02	2	• Used to install the HW1E units into ø30 mounting holes. • IP65 • Cannot be used with anti-rotation ring and nameplate. • Mounting panel thickness: 1.6 to 3.8 mm

Maintenance Parts					
Shape	Specification	Type No.	Ordering Type No.	Package Quantity	Remarks
Contact Block 	1NO contact	HW-G10	HW-G10	1	
	1NC contact	HW-G01	HW-G01	1	
	EM (early make) contact	HW-G10R	HW-G10R	1	
	LB (late break) contact	HW-G01R	HW-G01R	1	
Dummy Block 		TW-DB	TW-DBPN10	10	
Full Voltage Adapter 		HW-GA1	HW-GA1PN02	2	
Transformer 	100/110V AC	HW-T16	HW-T16	1	• For illuminated pushbuttons and illuminated selector switches.
	200/220V AC	HW-T26	HW-T26	1	
Dome Lens for Pilot Light 	AS resin	HW1A-P2②	HW1A-P2②PN05	5	• Specify a color code in place of ②. A (amber), G (green), R (red), S (blue), W (white), and Y (yellow)

ø22 HW Series Accessories and Replacement Parts



Maintenance Parts

Shape	Specification	Type No.	Ordering Type No.	Package Quantity	Color Code	
	Round flush with round or square bezel	Polyacetal	HW1A-B1①	HW1A-B1①PN05	5	B (black) G (green) R (red) S (blue) W (white) Y (yellow)
	Round extended with round or square bezel		HW1A-B2①	HW1A-B2①PN05	5	
	Square flush		HW2A-B1①	HW2A-B1①PN05	5	
	Square extended		HW2A-B2①	HW2A-B2①PN05	5	
	ø29mm mushroom		HW1A-B3①	HW1A-B3①PN02	2	
	ø40mm mushroom		HW1A-B4①	HW1A-B4①PN02	2	
	Round flush	Polyarylate	HW9Z-L11②	HW9Z-L11②PN05	5	A (amber), C (clear), G (green), R (red), S (blue), Y (yellow) Note: Use a clear lens for white illumination.
	Square flush		HW9Z-L21②	HW9Z-L21②PN05	5	
	Round extended		HW9Z-L12②	HW9Z-L12②PN05	5	
	ø29mm mushroom	AS, Marking type	ALW31L-②	ALW31L-②PN02	2	C (clear), G (green), R (red), S (blue)
			ALW31LD-②	ALW31LD-②PN02	2	A (amber), Y (yellow)
	ø40mm mushroom		ALW41L-②	ALW41L-②	1	C (clear), G (green), R (red), S (blue)
			ALW41LD-②	ALW41LD-②	1	A (amber), Y (yellow)
	Round flush	Acrylic	HW9Z-P11	HW9Z-P11PN05	5	• White
	Round extended		HW9Z-P12	HW9Z-P12PN05	5	
	Square flush		HW9Z-P21	HW9Z-P21PN05	5	
	ø29/40mm mushroom		ALW3B	ALW3BPN05	5	
		Polyarylate	HW9Z-FDY②	HW9Z-FDY②	1	A (amber) G (green) R (red) S (blue) W (white) Y (yellow)
	Key selector switch	Metal	HW9Z-SK-231	HW9Z-SK-231PN02	2	
		Plastic	HW9Z-LN	HW9Z-LNPN05	5	• Black
	Standard	Rubber	HW9Z-CPM	HW9Z-CPM	1	
			HW9Z-BLM	HW9Z-BLM	1	
		Plastic	HW9Z-LS	HW9Z-LSPN10	10	• Yellow





Note: Specify a button color code or lens color code in place of ① or ② in the Ordering Type No.

Maintenance Parts

LED Lamps (LSTD Type)

Operating Voltage	Current Draw		Type No.	Ordering Type No.	Illumination Color Code	Package Quantity	Base
	AC	DC					
6V AC/DC ±5% 	17 mA (A, R, W, Y) 8 mA (G, PW, S)	14 mA (A, R, W, Y) 5.5 mA (G, PW, S)	LSTD-6*	LSTD-6②	Specify a color code in place of ② in the Ordering Type No. A: amber G: green PW: pure white R: red S: blue W: white Y: yellow	1	BA9S/13
				LSTD-6②PN10		10	
12V AC/DC ±10% 	11 mA	10 mA	LSTD-1*	LSTD-1②	1		
				LSTD-1②PN10	10		
24V AC/DC ±10% 	11 mA	10 mA	LSTD-2*	LSTD-2②	1		
				LSTD-2②PN10	10		

Incandescent Lamps (LS Type)

Rated Operating Voltage	Lamp Ratings	Type No.	Package Quantity
6V AC/DC 	1W (6.3V)	LS-6	1
12V AC/DC 	1W (18V)	LS-8	
18V AC/DC 	1W (24V)	LS-2	
24V AC/DC 	1W (30V)	LS-3	

Transformer

Shape	Primary Voltage	Secondary Voltage	Type No.	Applicable Load
Separate Mounting Type 	100/110V AC	5.5V	TWR516	One full voltage type pilot light or illuminated switch containing LSTD-6 LED lamp (6V AC/DC) or LS-6 incandescent lamp (6V AC/DC, 1W)
	200/220V AC		TWR526	
	400/440V AC		TWR546	

Safety Precautions

- Turn off the power to the HW series control units before starting installation, removal, wiring, maintenance, and inspection of the products. Failure to turn power off may cause electrical shocks or fire hazard.
- To avoid a burn on your hand, use the lamp holder tool when replacing lamps.
- For wiring, use wires of a proper size to meet the voltage and current requirements. Tighten the M3.5 terminal screws to a tightening torque of 1.0 to 1.3 N·m. Failure to tighten terminal screws may cause overheat and fire.

Instructions

Panel Mounting

Remove the contact block from the operator (for transformer type pilot lights, remove the transformer from the illumination unit). Remove the locking ring from the operator. Insert the operator into the panel cut-out from the front, tighten the locking ring from the back, then install the contact block to the operator.

• Removing and Installing the Contact Block

1. To remove the operator from the contact block, turn the locking lever in the direction of the arrow shown below. Then the operator can be pulled out.
2. To reinstall, place the TOP markings on the operator and the contact block mounting adapter in the same direction, and insert the operator into the contact block mounting adapter. Then turn the locking lever in the opposite direction.

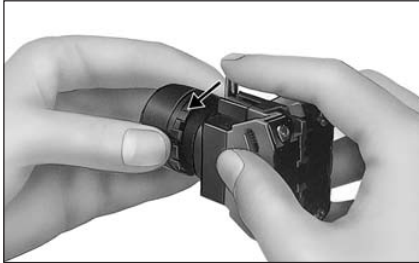

• Removing and Installing the Transformer Unit on Pilot Lights

1. Insert a flat screwdriver (5mm wide at the maximum) into the latch hole on the transformer unit as shown in the photo below, and disengage the latch. Then pull out the illumination unit.
2. To reinstall, place the TOP marking on the illumination unit and the latch in the same direction, and push the illumination unit into the transformer unit.

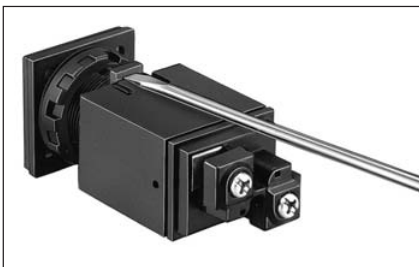

• Notes for Panel Mounting

1. When mounting the operator onto a panel, use the optional locking ring wrench (MW9Z-T1) to tighten the locking ring. Tightening torque must not exceed 2.0 N·m. Do not use pliers. Excessive tightening will damage the locking ring.
2. For the contact blocks and transformers housing LED and incandescent lamps, make sure not to press the lamps too hard, otherwise the lamp socket may be impaired.

• Notes for Illuminated Pushbuttons

The full shroud cannot be removed from the extended full shroud type.

Safety Lever Lock

IDEC strongly recommends using the safety lever lock (HW9Z-LS, yellow) to prevent heavy vibration or maintenance personnel from unlocking contacts.

1. HW series can be mounted vertically with a minimum spacing of 50 mm (70 mm for mono-lever switches) but spacing should be determined to ensure easy operation.
2. Mount the control unit onto the panel, lock the lever, and strongly push in the safety lever lock to install.
3. When the spacing is narrower than the recommended value, with the lever unlocked, mount the safety lever lock and insert the contact unit to the operator. Then, lock the lever and strongly push in the safety lever lock to install.
4. To remove the safety lever lock, insert a flat screwdriver into the safety lever lock and push upwards.

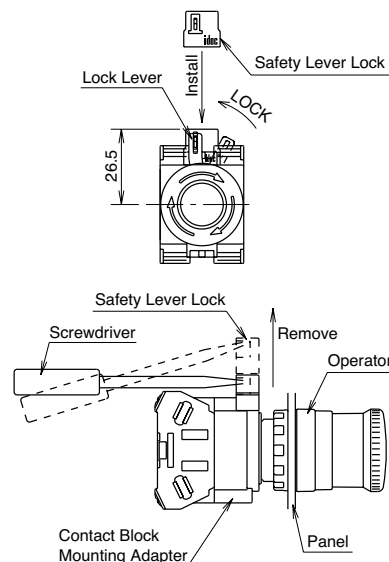

Instructions

Replacement of Lens and Marking Plate

• **Removing**

1. Remove the lens unit (color lens, marking plate, and lens holder) by inserting a screwdriver into the recess of the lens through the bezel.

[Removing the Lens Unit]

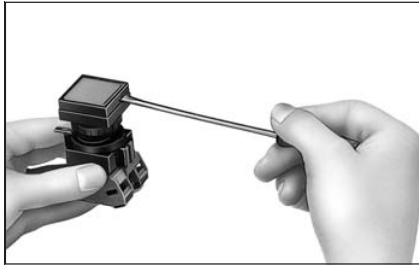

2. Remove the marking plate by pushing the lens from the rear to disengage the latches between the lens and the lens holder, using the screwdriver as shown below.

[Removing the Lens]

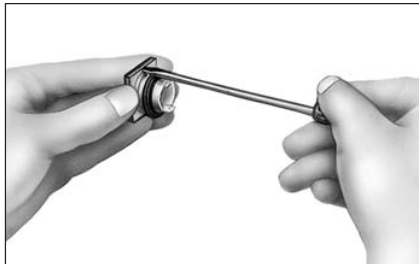

Note: The translucent filter in the lens holder cannot be removed because this filter is sealed to make the unit waterproof and oiltight.

• **Installing**

[For Round Lens Type]

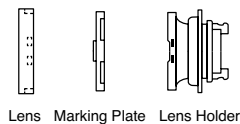

1. Place the marking plate on the lens holder with the anti-rotation projection engaged and press the lens onto the lens holder to engage the latches.
2. Place the marking plate in the correct orientation.

[For Square Lens Type]

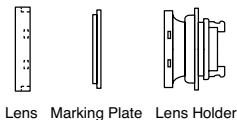

1. Place the marking plate on the lens holder and press the lens onto the lens holder to engage the latches.
2. Place the marking plate in the correct orientation.

Marking

For HW series illuminated pushbuttons and pilot lights, legends and symbols can be engraved on the built-in marking plates, or printed film can be inserted under the lens for labeling purposes. Films are not supplied with illuminated pushbuttons, and may be provided by the user.

• **Marking Plates and Marking Film Size**

Lens Style	Round Lens Type	Square Lens Type
Built-in Marking Plate		
Applicable Marking Film		

- Engraving must be made on the engraving area within 0.5mm deep.
- The marking plate is made of white acrylic resin.
- Mylar for printing labels is not included and must be provided and printed by the user.
- Two 0.1mm-thick films or one 0.2mm-thick film can be installed in the lens.
- Recommended marking film: Mylar

• **Insertion Order of Marking Plate and Film**

[Round Lens Type]

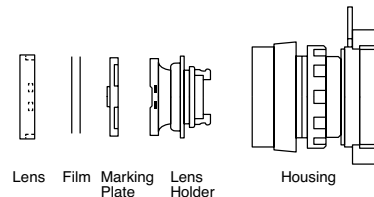

Note: Films are not included.

[Square Lens Type]

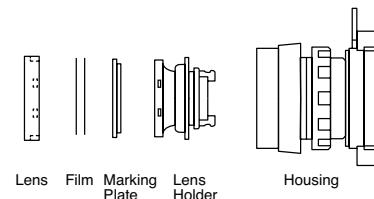

Note: Films are not included.
Place the marking plate in the correct orientation.

Instructions

Replacement of Lamps

Lamps can be replaced by using the lamp holder tool (OR-55) from the front of the panel, or by removing the contact block from the operator unit.

• Removing the Lamps from the Front of the Panel

[How to Remove]

1. To remove, slip the lamp holder tool onto the lamp head lightly. Then push slightly, and turn the lamp holder tool counterclockwise.



[How to Install]

1. To install, insert the lamp head into the lamp holder tool, and hold the lamp as shown in the figure below.

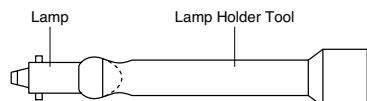

2. Place the pins on the lamp base to the grooves in the lamp socket. Insert the lamp and turn it clockwise.

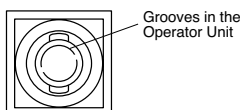

Nameplate

When anti-rotation is not required, remove the projection from the nameplate using pliers.

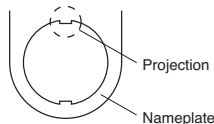

Close Mounting

When mounting the units closely in a horizontal row on 30mm centers, use optional barriers to prevent interconnection between adjoining terminals. The barriers can be attached simply by pressing them onto the sides of contact blocks.

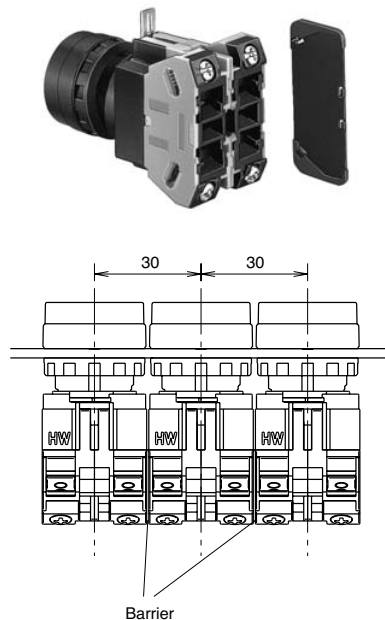

When mounting transformer type illuminated units closely in a horizontal row on 30mm centers, insert solid wires or stranded wires into inside of the terminal screw on the transformer (see figure below) to prevent short circuit between adjoining terminals.

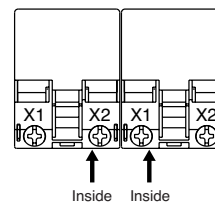

When using transformer type pilot lights closely mounted in horizontal and vertical rows on 30mm centers, keep the ambient temperature below 40°C.

Instructions

Tightening Torque for Terminal Screws

Tighten the M3.5 terminal screws to a torque of 1.0 to 1.3 N·m.

Installation of LED Illuminated Units

1. When using full voltage type LED illuminated units, provide protection against electrical noise, if necessary.

2. Notes for Pure White LED Lamps

- Do not use the pure white LED outdoors, otherwise it will lead to the degradation of brightness and color. Do not remove or apply shock to the cap on the pure white LED lamp, otherwise it may break or damage the cap.
- Use a white lens. The illumination color will be dull if a different color lens is used.

Applicable Wiring

The applicable wire size is 2mm² maximum. (Solid wire ø1.6 mm max.) One or two wires can be connected.

• Applicable Crimping Terminal

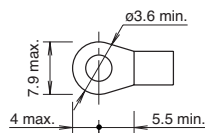

Be sure to use an insulation tube or cover on the crimping part of the crimping terminal to prevent electrical shocks.

• Solid Wire

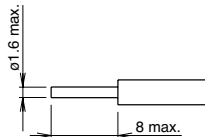

Note: Contact Block and Transformer
When connecting wires in the direction shown below, keep the insulation stripping length 6.6 mm at the maximum.

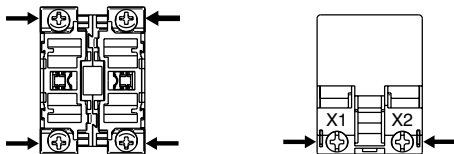

Anti-rotation Ring and Panel Cut-out

Align the TOP marking on the operator and the ▲ mark on the anti-rotation ring with the recess in the mounting panel.

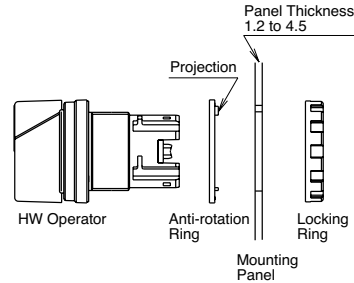

• Panel Cut-out

(Complies with IEC947-5-1)

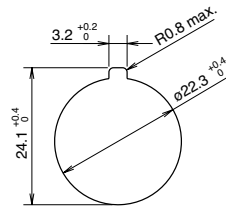

Unibody Pushlock Turn Reset

• Removing the lens

Remove the lens by inserting a screwdriver into the left or right recess of the lens. Be careful that the lens does not drop off.

• Removing the LED/incandescent lamp

Use a lens removal tool to remove the lamp. See page 46 for more information.

• Notes for Wiring

Ensure that the crimping terminal of each wiring is properly insulated.

Key Selector Switch

• Notes for using a different key

When a different number key is inserted into the key hole, it will not normally operate. However, if the key is forced to turn or is not inserted properly, it may be turned.

ø22 HW Series Control Boxes



Control Boxes

Control Box (Gray Cover)

Shape	Contact	Type No.	Button Color	Mounted Unit (Operator)
With Pushbutton HW1X-BM 	1NO	HW1X-BM110①	Specify a button color code in place of ① in the Type No. B: black G: green R: red S: blue W: white Y: yellow	HW1B-M1
	1NO-1NC	HW1X-BM111①		

Shape	No. of Positions	Contact Code	Contact Block		Operator Position			Type No.	Mounted Unit (Operator)
			Mounting Position	Type	L	C	R		
With Selector Switch HW1X-S 	90° 2-position Maintained	10 (1NO)	1	NO		—	●	HW1X-S2T10	HW1S-2T
			2	Dummy					
		11 (1NO-1NC)	1	NO		—	●	HW1X-S2T11	
			2	NC	●	—			
	45° 3-position Maintained	20 (2NO)	1	NO	●			HW1X-S3T20	HW1S-3T
			2	NO			●		

Emergency Stop Control Box (Yellow Cover)

Shape	Contact	Type No.	Button Color	Mounted Unit (Operator)
With Pushlock Turn Reset Switch HW1X-BV 	1NC	HW1X-BV401R	Red only	HW1B-V4R
	1NO-1NC	HW1X-BV411R		
	2NC	HW1X-BV402R		
With Pushlock Key Reset Switch HW1X-BX 	1NC	HW1X-BX401R	Red only	HW1B-X4R
	1NO-1NC	HW1X-BX411R		
	2NC	HW1X-BX402R		

Accessories

Name	Type No.	Ordering Type No.	Package Quantity	Remarks
Nameplate	NSA-0	NSA-0	1	Black surface, made of aluminum 0.8 mm thick
		NSA-0PN10	10	
Cover Gasket	HW9Z-W	HW9Z-WPN05	5	Made of rubber
Connector Locking Nut	HW9Z-G	HW9Z-GPN05	5	Made of white plastic, G1/2 thread
	HW9Z-PG	HW9Z-PGPN05	5	Made of black plastic, PG16 thread

Ordering Information

- Unless otherwise specified, every control box is supplied with two connector locking nuts (G1/2 thread).
- When using PG16 connectors, specify as described below.

HW1X-BM110① - PG

_____ Supplied with two PG16 connector locking nuts

Specifications

Operating Temperature	-25 to +60°C (no freezing)	
Storage Temperature	-40 to +80°C (no freezing)	
Operating Humidity	45 to 80% RH (no condensation)	
Rated Insulation Voltage	600V	
Contact Resistance	50 mΩ maximum (initial value)	
Insulation Resistance	100 MΩ minimum (500V DC megger)	
Electric Shock Protection Class	Class II (IEC 61140)	
Dielectric Strength	Between live and dead parts: 2,500V AC, 1 minute	
Vibration Resistance	Operating extremes: 5 to 55 Hz, amplitude 0.5 mm	
Shock Resistance	Damage limits: 1,000 m/s ² Operating extremes: 100 m/s ²	
Mechanical Life (minimum operations)	Pushbuttons, momentary:	5,000,000
	Selector switches:	500,000
	Pushlock turn reset switches:	500,000
Electrical Life (minimum operations)	Pushbuttons, momentary:	500,000 *1
	Selector switches:	500,000 *2
	Pushlock turn reset switches:	500,000 *3
	(Switching frequency)	
	*1 1,800 operations/h, duty ratio 40%	
	*2 1,200 operations/h, duty ratio 40%	
	*3 900 operations/h, duty ratio 40%	
Conduit Port	ø23mm knockout on top and bottom	
Applicable Connector	G1/2 or PG16 (plastic fitting)	
Applicable Wire	Solid wire: ø1.6mm maximum Stranded wire: 2.0 mm ² maximum	
Mounting Screw	Two M4 screws Tightening torque 1.4 to 2.0 N·m	
Degree of Protection	IP65 (IEC 60529)	

Contact Ratings

Contact Block	Rated Insulation Voltage	600V
	Rated Continuous Current	10A
	Contact Ratings by Utilization Category IEC 60947-5-1	AC-15 (A600) DC-13 (P600)

Applicable Standards and Approvals

Safety Standards	File No. or Organization
UL508	UL Listing File No. E68961
CSA C22.2 No. 14	c-UL (File No. E68961)
EN60947-5-1	TÜV PS No. B98 08 13332 398

Attachments

Name	Type No.	Quantity
Nameplate	*1 NSA-0	1
Cover Gasket	*2 HW9Z-W	1
Connector Locking Nut	HW9Z-G	2

For details, see the instruction sheet attached to the control box.

*1: The nameplate is supplied with the pushbutton and selector switch control boxes, not with the emergency stop control box.

*2: The cover gasket is supplied with the emergency stop control box, not with the pushbutton and selector switch control boxes.

Characteristics

• Contact Ratings by Utilization Category

Operational Voltage		24V	48V	50V	110V	220V	440V	
Operational Current	AC 50/60 Hz	AC-12 Control of resistive loads and solid state loads	10A	—	10A	10A	6A	2A
		AC-15 Control of electromagnetic loads (> 72 VA)	10A	—	7A	5A	3A	1A
DC		DC-12 Control of resistive loads and solid state loads	8A	4A	—	2.2A	1.1A	—
		DC-13 Control of electromagnets	4A	2A	—	1.1A	0.6A	—

Note:

The operational current represents the classification by making and breaking currents (IEC 60947-5-1).

Minimum applicable load: 3V AC/DC, 5 mA (Applicable range may vary with operating conditions and load types.)

Dimensions

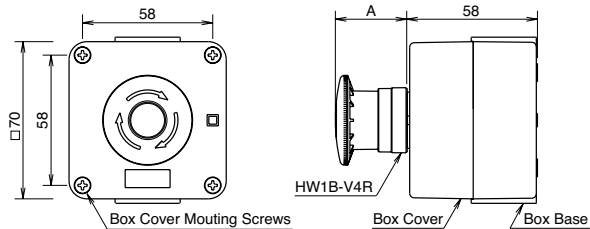

All dimensions in mm.

Control Unit (Operator)	Dimension A (mm)
Pushbutton	13.0
Selector Switch	21.0
Pushlock Turn Reset	32.0
Pushlock Key Reset	32.0 (Key inserted: 49.4)

ø22 HW Series Control Boxes

Mounting Hole Layout

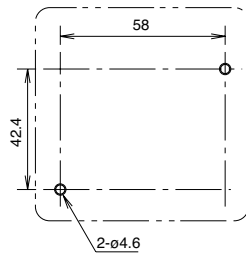

Applicable Terminal

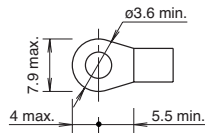

Tightening torque: 1.0 to 1.3 N·m
A maximum of two pieces can be connected to one terminal.

Nameplate

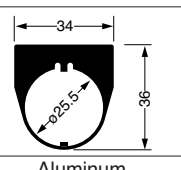
Type No.	NSA-0
Color: Black, without legend Thickness: 1.2 mm (Remove the anti-rotation projection)	
Material	Aluminum

The nameplate is supplied with the pushbutton and selector switch control boxes. When not using the nameplate, use the cover gasket (HW9Z-W).

HW series nameplates (HWA*) cannot be used.

Operating Instructions

• Panel Mounting

To mount the control box on a panel, use two M4 screws, plane washers and spring washers to preventing loosening. Tighten the screws to a torque of 1.4 to 2.0 N·m.

Determine the screw length in consideration of the panel thickness.

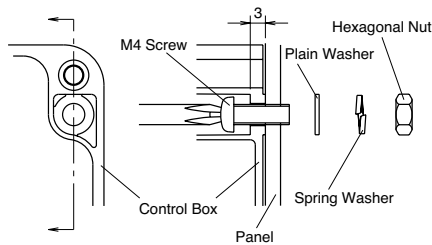

• Applicable Connector and Installation

- To install a connector, break open the conduit port on the top and bottom of the control box. Before opening the conduit port, remove the attached two connector locking nuts from the control box base. Place the tip of a screwdriver on the conduit port and strike the screwdriver end. Make sure that the conduit port is free from burrs and cracks, which may hamper waterproof characteristics.

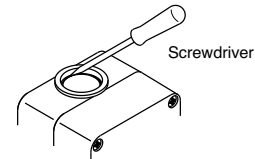

- Use G1/2 or PG16 connectors which can mount on a panel of 4.0 mm thick minimum. To install the connector to the control box, use the attached connector locking nut and tighten the locking nut sufficiently. If the locking nut is tightened insufficiently, the waterproof characteristics are not ensured.

Thread Size	Locking Nut Color	Locking Nut Type No.
G1/2	White	HW9Z-G
PG16	Black	HW9Z-PG

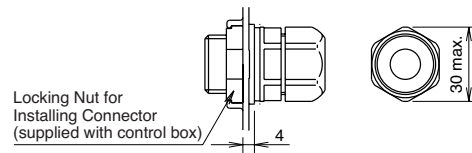

- Only when using a plastic connector, Insulation Class II (IEC 61140) is satisfied.
- Install the box cover flat on the box base. When the box cover is installed diagonally, the box cover cannot be secured correctly, resulting in an operation error.

• Applicable Cables

Applicable CVV Cable	Outside Diameter	Core Wires
1.25 mm ²	ø14.5 mm maximum	8 maximum
2.0 mm ²	ø14.5 mm maximum	8 maximum

• Applicable Conduits

Metal Conduit Outside Diameter	ø10 mm	ø12 mm
Conduit Inside Diameter	ø8.3 mm minimum	ø10.6 mm minimum
IV Wire Quantity	1.25 mm ²	2 to 3
	2.0 mm ²	2 to 3
		4 to 6
		3 to 4

Wire containment density: 32% to 48%

Select a cable appropriate for the connector.