

FEATURES

- 1. Slim, space-saving type (33 mm 1.299 inch wide) with four independent points on a base measuring 33 × 67 mm 1.299 × 2.638 inch. This contributes to a more compact control panel.**
- 2. PA relays, which have high sensitivity Au clad twin contacts, are installed.**
PA relays, 5 mm .197 inch wide, are installed. The PA relays feature high sensitivity (12 V type: 120 mW, 24 V type: 180 mW) and twin contacts with Au-cladding, which combine to ensure high reliability even with minute loads.
- 3. Can be mounted on a DIN rail or mounted directly (by screw).**
- 4. Equipped with an LED display to allow easy confirmation of operation.**
- 5. Possible to select relay for use in the 4-point terminal in accordance with load.**

Compliance with RoHS Directive

TYPES

1. RT-3 Unit relay

Contact arrangement	Rated input voltage	Part No.
1 Form A × 4	12 V DC	RT3S-12V
	24 V DC	RT3S-24V

Standard packing: Carton: 1 pc.; Case: 20 pcs.

Notes: 1. Cannot be equipped with Power PhotoMOS standard type relays. However, equipping with voltage-sensitive type of Power PhotoMOS relays is possible.
2. 5 V DC units are also available. Please inquire.
3. Please inquire about other contact arrangement.

2. 4-point Terminal

Type	Rated input voltage	Part No.
PA relay, Power PhotoMOS relay (Voltage sensitive type)	12, 24V DC	RT3BB

Standard packing: Carton: 1 pc.; Case: 20 pcs.

3. Mountable relays for 4-point Terminal (per relay, at 25°C 77°F, initial)

Product Name	Part No.
PA relay	PA1a-12V, PA1a-24V
Power PhotoMOS relay (Voltage sensitive type)	AQZ10*D (DC only)
	AQZ20*D (AC/DC dual use)

Note: Never install relays into this product other than those given above. Doing so will cause malfunction, breakdown, and breakdown of the connected product.

RATING

1. RT-3 Unit relay

1) Input ratings (per PA relay)

Part No.	Rated input voltage	Input current (at rated input voltage, 20°C 68°F)	Allowable variation of rated input voltage (-20 to +55°C -4 to +131°F)
RT3S-12V	12 V DC	Approx. 11.5 mA (Relay 10 mA + LED 1.5 mA)	12 V DC ± 10%
RT3S-24V	24 V DC	Approx. 10.5 mA (Relay 7.5 mA + LED 3 mA)	24 V DC ± 10%

RT-3 Unit Relay/4-point Terminal (PA Relay type)

2) PA relay coil specifications (reference value)

Relay part No.	Pick-up voltage (Initial) (at 20°C 68°F)	Drop-out voltage (Initial) (at 20°C 68°F)	Coil resistance (±10%) (at 20°C 68°F)	Nominal operating power
PA1a-12V	70%V or less of nominal voltage	5%V or more of nominal voltage	1,200 Ω	120 mW
PA1a-24V			3,200 Ω	180 mA

3) Output ratings (per PA relay)

Specification	Item	Specifications
Contact rating	Rated control capacity (resistive load)	3 A 250 V AC, 3 A 30 V DC
	Maximum allowable contact power (resistive load)	500 VA (AC), 60 W (DC)
	Maximum allowable contact voltage	250 V AC, 30 V DC
	Maximum allowable contact current	3 A
	Minimum load (reference value)	100 mV 100 μA
Expected life	Electrical (resistive load)	Min. 3 × 10 ⁴ : 3 A 250V AC Min. 3 × 10 ⁴ : 3 A 30V DC Min. 10 ⁵ : 2 A 250V AC Min. 10 ⁵ : 2 A 30V DC
	Mechanical	Min. 2 × 10 ⁷ (at 180 times/min.)

Note: During 4-point simultaneous operation, the rating per point is also as shown above.

2. 4-point Terminal

1) Input ratings (per relay)

Rated input voltage	Allowable variation of rated input voltage	Allowable input voltage
12, 24V DC	12V DC±10%, 24V DC±10%	0.2A

Note: The input voltage value above is the allowable current when no relay is installed. Please note that input voltage is determined by the type of relay installed.

2) Input rating when PA relay installed (per relay, at 20°C 68°F)

Type	Rated voltage input	Operate voltage (Initial)	Release voltage (Initial)	Input current (during application of rated input voltage)
PA1a-12V	12V DC	Max. 9.5V DC (Relay max. 8.4V + include diode max. 1.1V)	Min. 1.0V DC (Relay min. 0.6V + include diode min. 0.4V)	Approx. 11.5mA (Relay 10mA + LED 1.5mA)
PA1a-24V	24V DC	Max. 17.9V DC (Relay max. 16.8V + include diode max. 1.1V)	Min. 1.6V DC (Relay min. 1.2V + include diode min. 0.4V)	Approx. 10.5mA (Relay 7.5mA + LED 3mA)

3) Input rating when Power PhotoMOS relay voltage sensitive type installed (per relay, at 25°C 77°F)

Type	Rated voltage input	Operate voltage (Initial)	Release voltage (Initial)	Input current (during application of rated input voltage)
AQZ*0*D	12, 24V DC	Max. 5.1V DC (Relay max. 4.0V + include diode max. 1.1V)	Min. 1.2V DC (Relay min. 0.8V + include diode min. 0.4V)	Approx. 10.0mA (Relay 7.0mA + LED 3mA)

4) Output rating (per relay)

Allowable load voltage	Allowable load current
600V (DC), 600V (AC peak value)	3A

Note: The value above is the allowable value when no relay is installed.

Please note that limitations apply to the load voltage and current depending on the type of relay installed.

5) Output rating when PA relay installed (per relay, at 20°C 68°F)

Specification	Item	Specifications
Contact rating	Rated control capacity (resistive load)	3 A 250 V AC, 3 A 30 V DC
	Maximum allowable contact power (resistive load)	750 VA (AC), 90 W (DC)
	Maximum allowable contact voltage	250 V AC, 30 V DC
	Maximum allowable contact current	3 A
	Minimum load (reference value)	100 mV 100 μA
Expected life	Electrical (resistive load)	Min. 3×10 ⁴ : 3 A 250V AC, 3 A 30V DC Min. 10 ⁵ : 2 A 250V AC, 2 A 30V DC
	Mechanical	Min. 2×10 ⁷ (at 180 times/min.)

Note: During 4-point simultaneous operation, the rating per point is also as shown above.

6) Output rating when Power PhotoMOS relay voltage sensitive type installed (per relay, at 25°C 77°F)

Possible relays		Maximum load voltage (DC, AC peak value)	Continuous load current (DC, AC peak value)	Possible relays		Maximum load voltage (DC, AC peak value)	Continuous load current (DC, AC peak value)
Type	Part No.			Type	Part No.		
DC only	AQZ102D	60V	1.80A	AC, DC dual use	AQZ202D	60V	1.350A
	AQZ105D	100V	1.15A		AQZ205D	100V	0.900A
	AQZ107D	200V	0.55A		AQZ207D	200V	0.450A
	AQZ104D	400V	0.30A		AQZ204D	400V	0.225A

Notes: 1. During 4-point simultaneous operation, the rating per point is also as shown above.

2. Please use a load current that is within the range of the data given below in "REFERENCE DATA Load current vs. ambient temperature characteristics".

RT-3 Unit Relay/4-point Terminal (PA Relay type)

SPECIFICATIONS

RT-3 Unit relay/4-point Terminal

Item	Specifications
Breakdown voltage	Between input and output 2,000 Vrms for 1 min.
	Between different terminals (between relays, both ways) 1,500 Vrms for 1 min.
Insulation resistance	Min. 100 MΩ (Using 500 V DC megger)
Vibration resistance (destructive)	10 to 55 Hz at double amplitude 1 mm .039 inch
Vibration resistance (functional)	10 to 55 Hz at double amplitude 1 mm .039 inch
Shock resistance (destructive)	Min. 196 m/s ²
Shock resistance (functional)	Min. 98 m/s ²
Ambient temperature	-20°C to +55°C -4°F to +131°F
Ambient humidity	35% to 85% R.H. (Not condensing)
Storage temperature	-30°C to +80°C -22°F to +176°F (Not freezing and condensing)
Terminal screw fasten torque	0.3 to 0.5 N-m
Coil surge absorber	Diode (1A, 400V)
Cross connection protecting diode	1.5 A, inverse voltage 40 V
Unit weight	Approx. 100 g 3.53 oz

- Notes: 1. The value of breakdown voltage and insulation resistance is the initial one.
 2. Condensing occurs when the unit relay is exposed to sudden temperature change in a high temperature and high humidity atmosphere. This may cause some troubles like insulation failure of the socket or the print circuit board. Take care under this condition.
 3. Below 0°C 32°F, condensing water can freeze and cause socket contact failures and other problems. Take care under this condition.

REFERENCE DATA

1. Maximum value for switching capacity (output)
Per PA relay

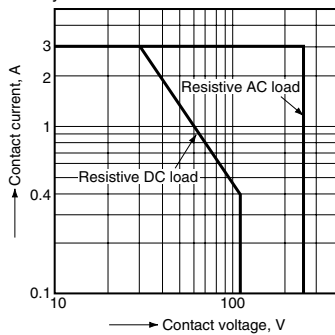

2. Load current vs. ambient temperature characteristics (DC only)

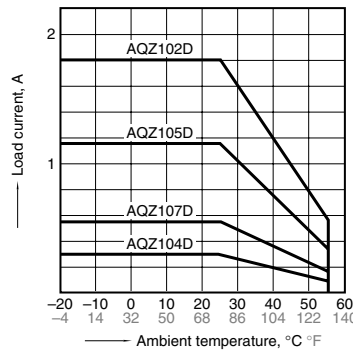

3. Load current vs. ambient temperature characteristics (AC/DC dual use)

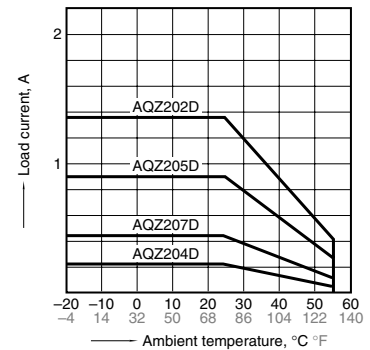

DIMENSIONS (mm inch)

1. External dimensions

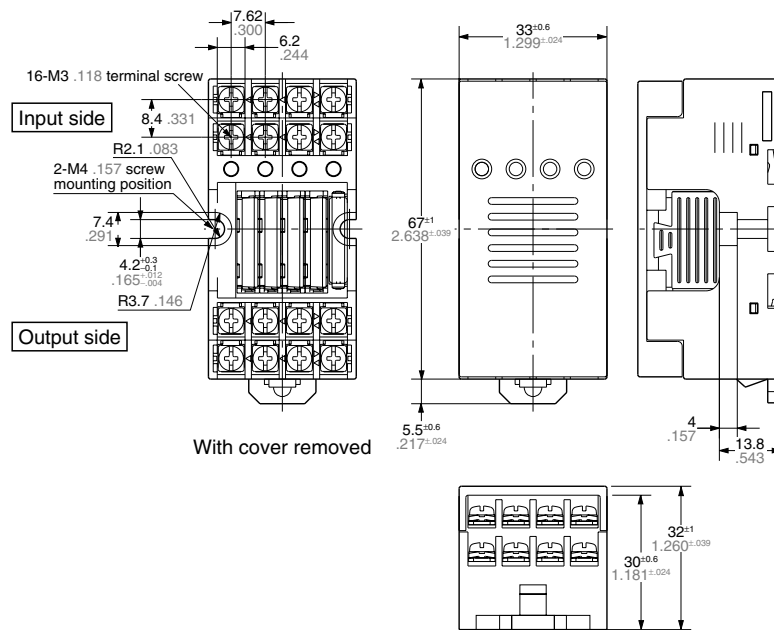

2. Schematic

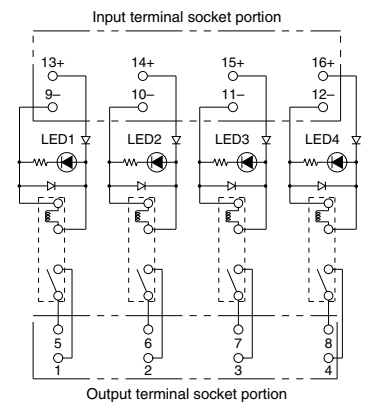

3. Mounting hole pattern

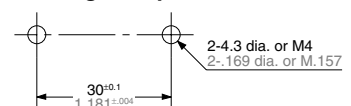

1. Never install modules (relays) into this product other than those designated. Doing so will cause malfunction, breakdown, and breakdown of the connected product.
2. If a unit is dropped be sure to check its external appearance and characteristics before using it.
3. The operation and return voltage values when equipped with PA relays are based on the relay terminals being face down. (RT-3 Unit relay (PA type), 4-point Terminal)

4. Switching lifetime (PA relay)

This characteristic depends on the relay and is effected by coil driving circuit, load type, activation frequency, activation phase, ambient conditions and other factors.

Also, be especially careful of loads such as those listed below.

1) When used for AC load-operating and the operating phase is synchronous, rocking and fusing can easily occur due to contact shifting.

2) Frequent switching under load condition

When high frequently switched under load condition that can cause arc at the contacts, nitrogen and oxygen in the air is fused by the arc energy and HNO_3 is formed. This can corrode metal materials. Three countermeasures for these are listed here.

(1) Incorporate an arc-extinguishing circuit.

(2) Lower the operating frequency

(3) Lower the ambient humidity

5. Operating environment

1) Keep the product as far way as possible from power cables, high tension equipment, power equipment, equipment with transmitting devices such as amateur radios, or equipment which generates a large switching surge.

2) The main unit is made of resin; therefore, do not use it in areas where it may come in contact with (or be exposed to) organic solvents such as gasoline, thinner, and alcohol, or strong alkaline substances such as ammonia and caustic soda.

3) Do not use the product in areas where it may be exposed to flammable gases, corrosive gases, excessive dust, or moisture, or areas where it may be subjected to strong vibration or shock.

6. Installing and removing the module

1) Firmly insert the module into the socket with the terminals going in the direction of the blade receptacles.

2) The module can be easily removed using the removal key.

(1) Insert the removal key into the socket slots.

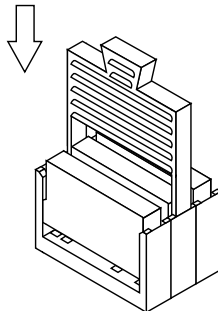

(2) Pull the removal key up to remove the module.

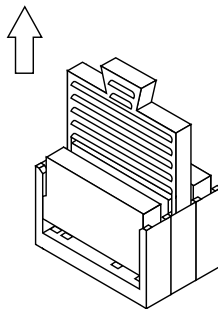

(3) Slide the removal key off of the module.

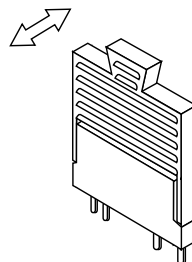

7. Wiring and circuit configuration

1) Perform wiring according to the internal schematic. Take care not to make any mistakes.

In particular, with the RT-3 Unit relay (PA relay type) and 4-point terminal, be careful of the polarity on the output side when equipped with AQZ10*D (DC type). Also, with the RT-3 Unit relay (Power PhotoMOS relay type), be careful of the polarity on the output side of the DC type (RT3SP1-***V for type equipped with AQZ102).

2) We recommend the use of wire-pressed terminals for connection to the terminal portion.

• Example of applicable wire-pressed terminal

Company Name	Part Name	Applicable wire-pressed terminal
J.S.T. Mfg Co., Ltd.	1.25 to C3A	0.25 to 1.65mm ²

3) When the load is inductive, limit spike voltages generated from the load to less than the maximum load voltage. Typical circuits are shown below.

(1) Add a clamp diode to the load.

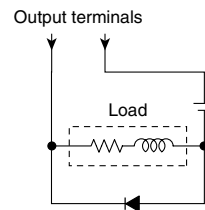

(2) Add an R-C snubber to the load.

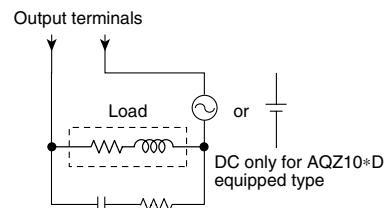

(3) Add a varistor between the output terminals.

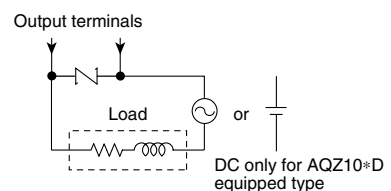

4) Even if spike voltages generated from the load are limited by a clamp diode or R-C snubber, inductances in long circuit wires will still create spike voltages. Keep wires as short as possible to minimize inductance.

CAUTIONS FOR USE

8. Installation

- 1) Perform mounting hole cutout according to the panel cutout drawings.
- 2) When installing the unit on a DIN rail, use the DIN rail locking lever on the side of the unit. Installation is accomplished by simply fitting the unit onto the rail and pressing gently.

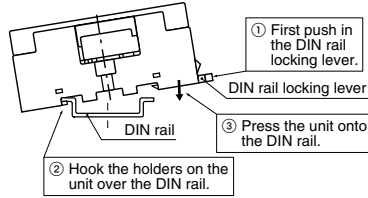

- 3) To remove the unit from the DIN rail, use a flat head screwdriver to pull out the DIN rail locking lever.

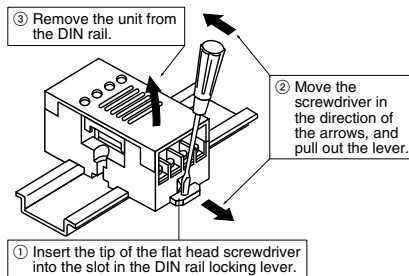

9. Transporting and storage

- 1) If the product is subjected to extreme vibration while being transported, the relays may become detached, the lead may become bent, and the unit may become damaged. Handle the carton and case with care.
- 2) If the product is stored in an extremely adverse environment, visible defects and deterioration of performance characteristics may result. We recommend the following storage conditions.
 - Temperature: 5 to 30°C 41 to 86°F
 - Humidity: Max. 60% R.H.
 - Environment: No hazardous substances such as sulfurous acid gases and little dust.

10. When equipped with Power PhotoMOS relay voltage drive type [RT-3 Unit relay (PA relay type), 4-point Terminal]

Since the Power PhotoMOS relay voltage sensitive type does not require the current-controlling resistance on the input side, it can be used together with PA relays on RT-3 unit relay (PA relay type) or RT-2 relay terminals. When connecting Power PhotoMOS relay voltage sensitive types, since it will be a close connection, it will be necessary to be careful of load currents. Be sure to refer to the information given regarding "Load currents vs ambient temperature characteristics" in the precautions given for use of 4-point terminals.

TERMINAL BLOCK

We recommend using wire-pressed terminals for connection to the terminal portion.

- Applicable electrical wire: 0.25 to 1.65 mm² .01 to .065 inch
- Applicable wire-pressed terminals (mm inch)

Company Name	Part Name	Part Name
J.S.T. Mfg Co., Ltd.	1.25 to C3A	1.25 to 3
NICHIFU	1.25Y to 3N	1.25 to 3
Nippon Tanshi Co., Ltd.	VD1.25 to 3	R1.25 to 3

ACCESSORIES

Short circuit plate for RT-3 Unit relay

Use when you want to bridge terminals.

< With insulator >

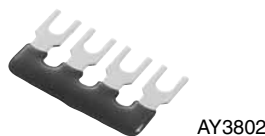

< Without insulator >



External dimensions (mm inch)

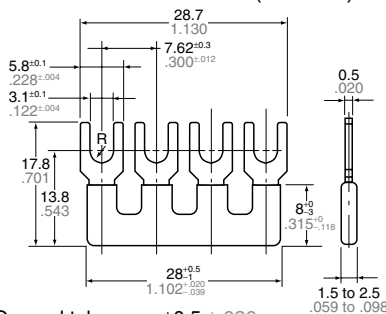

General tolerance: $\pm 0.5 \pm .020$

External dimensions (mm inch)

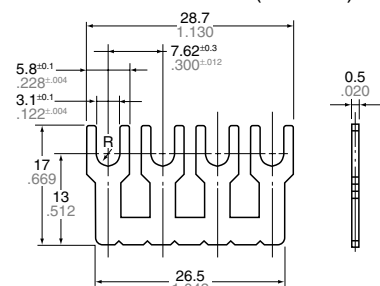

General tolerance: $\pm 0.5 \pm .020$