

RoHS Directive compatibility information
<http://www.nais-e.com/>

FEATURES

- **Low profile:**
22.5 mm(L)×15 mm(W)×15.7 mm(H)
.886 inch(L)×.591 inch(W)×.618 inch(H)
- **Low temperature rise**
Terminal temperature has been reduced compared with using our conventional product
- **Low sound pressure level**
Noise level has been reduced approx. 10dB compared with using our conventional product.
- **Wide line-up**
Micro ISO/Micro 280 terminal types and resistor and diode inside type, PCB terminal type (Micro 280 only).
- **Plastic sealed type**
Plastically sealed for automatic cleaning.

- **Compact and high-capacity 20A load switching**
N.O.: 20A 14V DC, N.C.: 10A 14V DC
(Max. carrying current: at 85°C 185°F)

TYPICAL APPLICATIONS

- Headlights
- Magnetic clutches
- Radiator fans
- Blowers
- Fog lamps
- Tail lights
- Heaters
- Defoggers
- Horns
- Condenser fans, etc.

SPECIFICATIONS

Contact

Arrangement	1 Form A	1 Form C
Contact material	Ag alloy (Cadmium free)	
Initial contact resistance (Initial) (By voltage drop 6 V DC 1 A)	Typ. 3 mΩ	
Contact voltage drop	N.O.: Max. 0.2 V (at 20 A)	N.O.: Max. 0.2 V (at 20 A switching) N.C.: Max. 0.5 V (at 10 A switching)
Rating	Nominal switching capacity	N.O.: 20 A 14 V DC N.C.: 20 A 14 V DC N.C.: 10 A 14 V DC
	Max. carrying current (Continuous, at 85°C 185°F)	N.O.: 20 A 12 V DC N.C.: 20 A 12 V DC N.C.: 10 A 12 V DC
	Min. switching capacity ^{#1}	1 A 12 V DC
Expected life (min. operation)	Mechanical (at 120 cpm)	Min. 10 ⁶
	Electrical (at rated load)	Min. 10 ⁵⁺¹

Coil

Nominal operating power	0.8 W, 1.0 W (with resistor inside type)
-------------------------	--

^{#1} This value can change due to the switching frequency, environmental conditions, and desired reliability level, therefore it is recommended to check this with the actual load.

Characteristics

Max. operating speed (at nominal switching capacity)	15cpm	
Initial insulation resistance ^{*2}	Min. 20MΩ (at 500 V DC)	
Initial breakdown voltage ^{*3}	Between open contacts	500 Vrms for 1min.
	Between contacts and coil	500 Vrms for 1min.
Operate time ^{*4} (at nominal voltage) (at 20°C 68°F)	Max. 10ms (initial)	
Release time ^{*4} (at nominal voltage) (at 20°C 68°F)	Max. 10ms (initial) Max. 15ms (initial) (with diode inside type)	
Shock resistance	Functional ^{*5}	Min. 100 m/s ² {10 G}
	Destructive ^{*6}	Min. 1,000 m/s ² {100 G}
Vibration resistance	Functional ^{*7}	10 Hz to 100 Hz, Min. 44.1 m/s ² {4.5 G}
	Destructive ^{*8}	10 Hz to 500 Hz, Min. 44.1 m/s ² {4.5 G}
Conditions in case of operation, transport and storage ^{*9} (Not freezing and condensing at low temperature)	Ambient temp	-40°C to +85°C -40°F to +185°F
	Humidity	5% R.H. to 85% R.H.
Mass	Approx. 15.0g .53 oz	

Remarks

- ^{*1} At nominal switching capacity, operating frequency: 2s ON, 2s OFF
- ^{*2} Measurement at same location as "Initial breakdown voltage" section.
- ^{*3} Detection current: 10mA
- ^{*4} Excluding contact bounce time.
- ^{*5} Half-wave pulse of sine wave: 11 ms; detection time: 10 μs
- ^{*6} Half-wave pulse of sine wave: 6 ms
- ^{*7} Detection time: 10 μs
- ^{*8} Time of vibration for each direction;
X, Y, Z direction: 4 hours



^{*9} Refer to Conditions for operation, transport and storage mentioned in AMBIENT ENVIRONMENT.
Please inquire if you will be using the relay in a high temperature atmosphere.

ORDERING INFORMATION

Ex. A CV 12

Product name	Contact arrangement	Mounting classification	Type classification	Coil voltage, V DC
CV	1: 1 Form C 3: 1 Form A	1: Micro ISO plug-in type 2: Micro 280 plug-in type 3: Micro 280 PC board type	0: Standard type 1: With diode inside 2: With resistor inside	12: 12

Note: Standard packing; Carton (Tube): 50 pcs.; Case: 200 pcs.

TYPES

Coil voltage (DC)	Contact arrangement	Mounting classification	Type classification	Part No.
12 V	1 Form A	Sealed type	Micro ISO plug-in type	ACV31012
			Micro 280 plug-in type	ACV32012
			Micro 280 PC board type	ACV33012
	1 Form C		Micro ISO plug-in type	ACV11012
			Micro 280 plug-in type	ACV12012
			Micro 280 PC board type	ACV13012

COIL DATA (at 20°C 68°F)

Nominal voltage, V DC	Pick-up voltage, * V DC (Initial)	Drop-out voltage, V DC (Initial)	Coil resistance, W	Nominal operating current, mA	Nominal operating power, W	Usable voltage range, V DC (at 85°C 185°F)
12	Max. 7.0	Min. 0.6	180±10% 142.3±10% (with resistor)	67±10% 84±10% (with resistor)	0.8 1.0 (with resistor)	10 to 16

* Other pick-up voltage types are also available. Please contact us for details.

DIMENSIONS

mm inch

1. Micro ISO terminal type

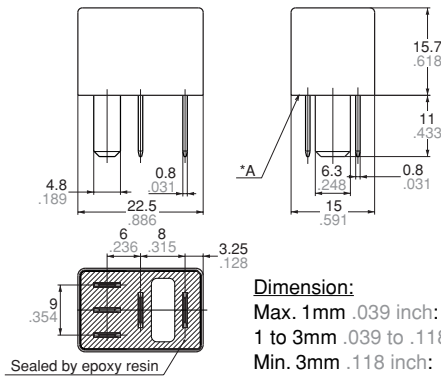

Schematic (Bottom view)
1 Form A

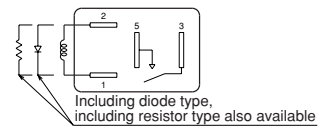

1 Form C

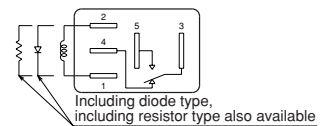

* Intervals between terminals is measured at A surface level.

CV (ACV)

2. Micro 280 terminal type

mm inch

1). Plug-in type

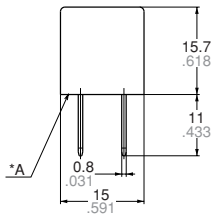
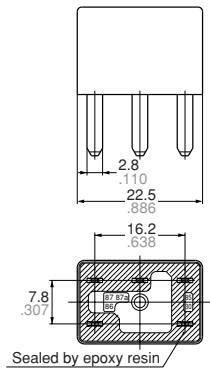

Dimension:	Tolerance
Max. 1mm .039 inch:	$\pm 0.1 \pm .004$
1 to 3mm .039 to .118 inch:	$\pm 0.2 \pm .008$
Min. 3mm .118 inch:	$\pm 0.3 \pm .012$

Schematic (Bottom view)
1 Form A

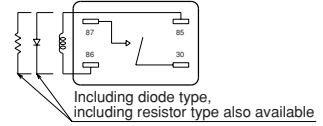

1 Form C

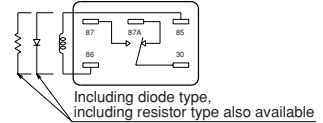

* Intervals between terminals is measured at A surface level.

2). PC board type

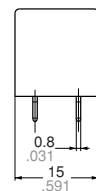
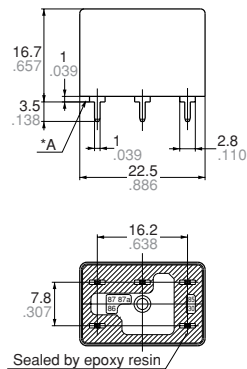

Dimension:	Tolerance
Max. 1mm .039 inch:	$\pm 0.1 \pm .004$
1 to 3mm .039 to .118 inch:	$\pm 0.2 \pm .008$
Min. 3mm .118 inch:	$\pm 0.3 \pm .012$

Schematic (Bottom view)
1 Form A

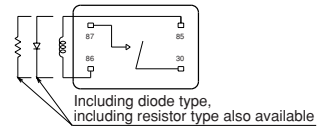

1 Form C

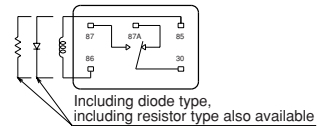

* Dimensions (thickness and width) of terminal specified in this catalog is measured before pre-soldering.
Intervals between terminals is measured at A surface level.

REFERENCE DATA

1. Coil temperature rise (20A)

Point measured: Inside the coil
Contact carrying current: 20A
Coil applied voltage: 13.5V

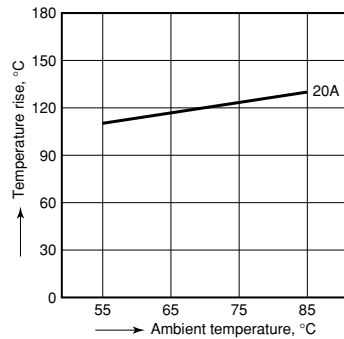

2. Distribution of pick-up and drop-out voltage

Sample: ACV11012, 100pcs

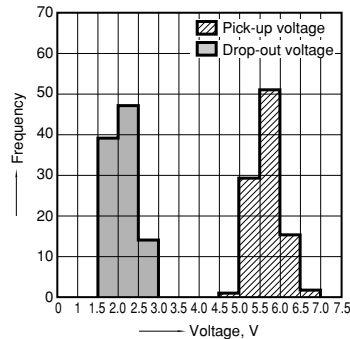

3. Distribution of operate and release time

Sample: ACV11012, 100pcs.

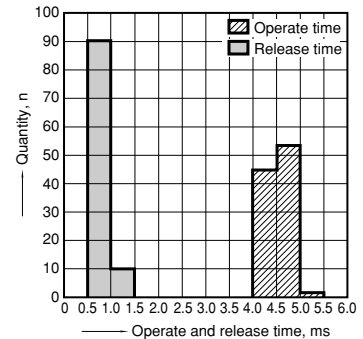

4-(1). Electrical life test (Resistive load)

Sample: ACV12212, 3pcs.
 Load: Resistive load (NC switching) 11A
 Switching frequency: (ON : OFF = 1s : 1s)
 Ambient temperature: Room temperature

Circuit

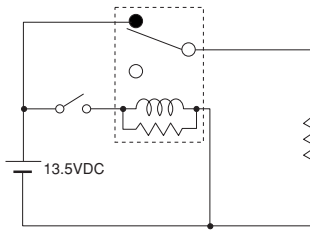

Change of pick-up and drop-out voltage

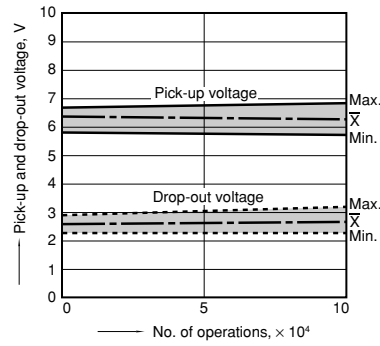

Change of contact resistance

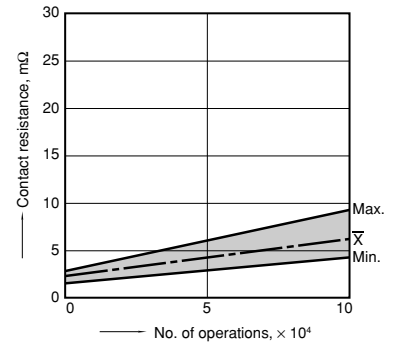

Load current waveform

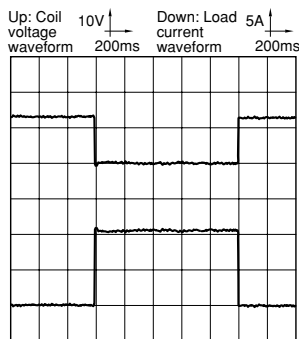

4-(2). Electrical life test (Lamp load)

Sample: ACV12212, 3pcs.
 Load: 55Wx4, inrush: 90A/steady: 20A, lamp actual load
 Switching frequency: (ON : OFF = 1s : 14s)
 Ambient temperature: Room temperature

Circuit

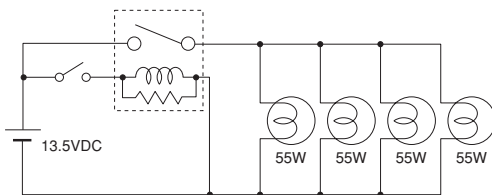

Change of pick-up and drop-out voltage

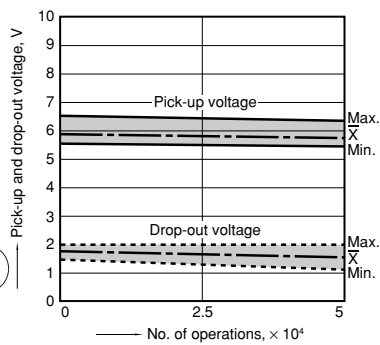

Change of contact resistance

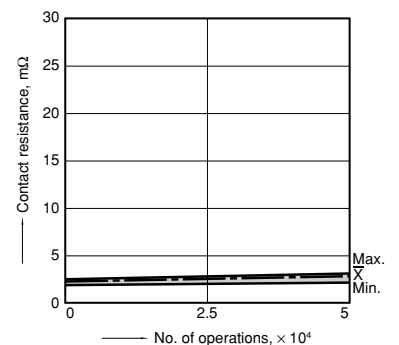

Load current waveform

Inrush current: 90A, steady current: 20A

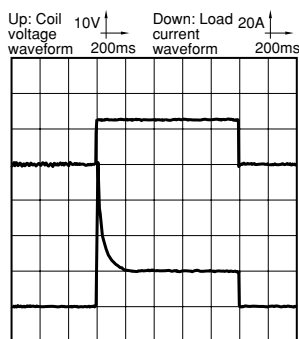

CV (ACV)

4-(3). Electrical life test (Motor load)

Sample: ACV12212, 3pcs.
 Load: inrush: 80A/steady: 18A,
 radiator fan actual load (motor free)
 Switching frequency: (ON : OFF = 2s : 6s)
 Ambient temperature: Room temperature

Circuit

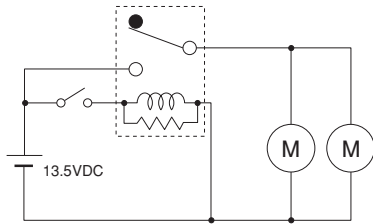

Load current waveform

Inrush current: 80A, steady current: 18A

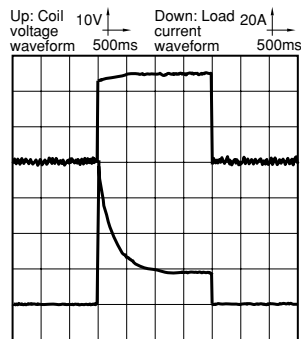

Change of pick-up and drop-out voltage

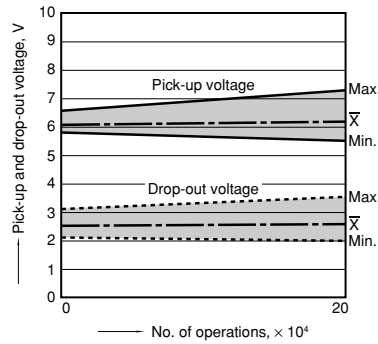

Change of contact resistance

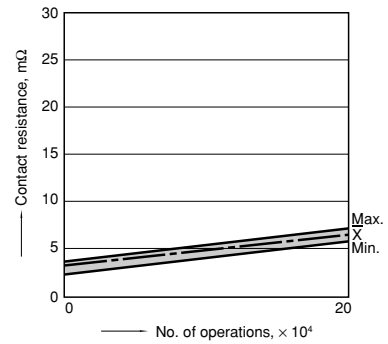

Cautions regarding the protection element

1. Part numbers without protection elements

- 12 V models

When connecting a coil surge protection circuit to these relays, we recommend a Zener diode with a Zener voltage of 24 V or higher, or a resistor (680Ω to 1,000Ω). When a diode is connected to the coil in parallel, the release time will slow down and working life may shorten. Before use, please check the circuit and verify that the diode is not connected in parallel to the coil drive circuit.

2. Part numbers with diodes

These relays use a diode in the coil surge protection element. Therefore, the release time is slower and the working life might be shorter compared to part numbers without protection elements and part numbers with resistors.

Be sure to use only after evaluating under actual load conditions.

3. Part numbers with resistors

This part number employs a resistor in the coil surge protection circuit; therefore, an external surge protection element is not required. In particular, when a diode is connected in parallel with a coil, the revert time becomes slower which could adversely affect working life. Please check the circuit and make sure that a diode is not connected in parallel with the coil drive circuit.

For Cautions for Use, see Relay Technical Information.