

mm inch

RoHS Directive compatibility information
<http://www.nais-e.com/>

FEATURES

- Approved to the supplementary insulation class in the EN standards (EN41003).

The insulation distance between the contact and coil meet the supplementary insulation class of the EN41003 standards as required for equipment connected to the telephone lines in Europe.

Satisfies the following conditions:

- Clearances: 2.0 mm .079 inch or more
- Creepage distance: 2.5 mm .098 inch or more

- 2,000 V breakdown voltage between contact and coil.

• **Outstanding surge resistance.**
Surge withstand between open contacts: 1,500 V 10×160 μsec. (FCC part 68)
Surge withstand between contact and coil: 2,500 V 2×10 μsec. (Telcordia)

- **High contact capacity: 2 A 30 V DC (Standard type)**

- **M.B.B. type available**

• **The use of gold-clad twin crossbar contacts ensures high contact reliability.**

SPECIFICATIONS

Contact

		Standard (B.B.M) type	M.B.B.type
Arrangement		2 Form C	2 Form D
Initial contact resistance, max. (By voltage drop 6 V DC 1 A)		100 mΩ	
Contact material		Standard contact: Ag+Au clad, AgPd contact (low level load): AgPd+Au clad (stationary), AgPd (movable)	
Rating	Nominal switching capacity (resistive load)	2 A 30 V DC	1 A 30 V DC
	Max. switching power (resistive load)	60 W	30 W
	Max. switching voltage	220 V DC	110 V DC
	Max. switching current	2 A	1 A
	Min. switching capacity (Reference value) ^{#1}	10 μA 10 mV DC	
	Nominal operating power	Single side stable	200 mW (1.5 to 12 V DC) 230 mW (24 V DC)
1 coil latching		150 mW (1.5 to 12 V DC) 170 mW (24 V DC)	—
Expected life (min. operations)	Mechanical (at 180 cpm)	10 ⁸	10 ⁷
	Electrical (at 20 cpm)	10 ⁵ (2 A 30 V DC resistive), 5 × 10 ⁵ (1 A 30 V DC resistive)	10 ⁵ (1 A 30 V DC resistive)

Notes:

#1 This value can change due to the switching frequency, environmental conditions, and desired reliability level, therefore it is recommended to check this with the actual load. (AgPd contact type or SX relays are available for low level load switching [10V DC, 10mA max. level])

#2 The upper limit for the ambient temperature is the maximum temperature that can satisfy the coil temperature rise. Under the packing condition, allowable temperature range is from -40 to +70°C -40° to +158°F.

Remarks

* Specifications will vary with foreign standards certification ratings.

*¹ Measurement at same location as "Initial breakdown voltage" section.

*² Detection current: 10 mA

*³ By resistive method; nominal voltage applied to the coil; contact carrying current: 2 A.

*⁴ By resistive method; nominal voltage applied to the coil; contact carrying current: 1 A.

*⁵ Nominal voltage applied to the coil, excluding contact bounce time.

*⁶ Nominal voltage applied to the coil, excluding contact bounce time without diode.

*⁷ Half-wave pulse of sine wave: 6 ms.; detection time: 10 μs.

*⁸ Half-wave pulse of sine wave: 11 ms.; detection time: 10 μs.

*⁹ Half-wave pulse of sine wave: 6 ms.

*¹⁰ Detection time: 10 μs.

*¹¹ Refer to 6. Conditions for operation, transport and storage mentioned in AMBIENT ENVIRONMENT.

Characteristics

		Standard (B.B.M) type	M.B.B.type
Initial insulation resistance ^{*1}		Min. 1,000 MΩ (at 500 V DC)	
Initial break-down voltage ^{*2}	Between open contacts	1,000 Vrms for 1 min.	500 Vrms for 1 min.
	Between contact and coil	2,000 Vrms for 1 min.	
Initial surge voltage (at 20°C)	Between open contacts, 10 × 160 μs	1,500 V [FCC Part 68]	—
	Between contact and coil, 2 × 10 μs	2,500 V [Telcordia]	
Temperature rise (at 20°C)		Max. 50°C ^{*3}	Max. 50°C ^{*4}
Operate time [Set time] ^{*5} (at 20°C)		Max. 4 ms [Max. 4 ms]	
Release time [Reset time] ^{*6} (at 20°C)		Max. 4 ms [Max. 4 ms]	
M.B.B. time ^{*12}		—	Min. 10 μs
Shock resistance	Functional	Min. 750 m/s ² {75 G} ^{*7}	Min. 500 m/s ² {50 G} ^{*8}
	Destructive ^{*9}	Min. 1,000 m/s ² {100 G}	
Vibration resistance	Functional ^{*10}	10 to 55 Hz at double amplitude of 3.3 mm	
	Destructive	10 to 55 Hz at double amplitude of 5 mm	
Conditions for operation, transport and storage ^{*11} (Not freezing and condensing at low temperature)	Ambient temp. ^{*2}	-40°C to +85°C -40°F to +185°F	
	Humidity	5 to 85%R.H.	
Unit weight		Approx. 2 g .071 oz.	

*¹² M.B.B. time:

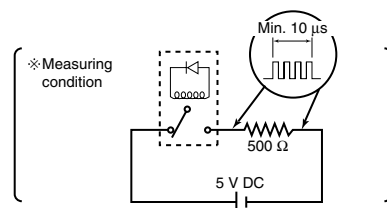

TX-D

TYPICAL APPLICATIONS

- Communications (XDSL, Transmission)
- Measurement
- Security
- Home appliances, and audio/visual equipment
- Automotive equipment
- Medical equipment

ORDERING INFORMATION

1) Standard (B.B.M.)type

Ex. TXD 2 SA - L - - 4.5V - Z

Contact arrangement	Surface-mount availability	Operating function	Terminal shape	Coil voltage (DC)	Packing style
2: 2 Form C	Nil: Standard PC board terminal or self-clinching terminal SA: Standard surface-mount terminal SL: High connection reliability surface-mount terminal type SS: Space saving surface-mount terminal type	Nil: Single side stable L: 1 coil latching	Nil: Standard PC board terminal or surface-mount type H: Self-clinching terminal	1.5, 3, 4.5, 5, 6, 9, 12, 24 V	Nil: Tube packing Z: Tape and reel packing (Picked from the 8/9/10/12-pin side)

2) M.B.B.type

Ex. TXD 2 SA - 2M - - 4.5V - Z

Contact arrangement	Surface-mount availability	Operating function	Terminal shape	Coil voltage (DC)	Packing style
2: 2 Form D	Nil: Standard PC board terminal or self-clinching terminal SA: Standard surface-mount terminal SL: High connection reliability surface-mount terminal type SS: Space saving surface-mount terminal type	2M: 2 M.B.B. type	Nil: Standard PC board terminal or surface-mount type H: Self-clinching terminal	1.5, 3, 4.5, 5, 6, 9, 12, 24 V	Nil: Tube packing Z: Tape and reel packing (Picked from the 8/9/10/12-pin side)

Notes: 1. Tape and reel (picked from 1/3/4/5-pin side) is also available by request. Part number. suffix "-X" is needed when ordering.
(ex.) TXD2SA-3V-X
2. Tape and reel packing symbol "-Z" or "-X" are not marked on the relay.

TYPES AND COIL DATA (at 20°C 68°F)

1. Standard (B.B.M.) type

(1) Standard PC board terminal and self-clinching terminal

1. Single side stable

Coil Rating, V DC	Part No. V DC		Pick-up voltage, V DC (max.) (initial)	Drop-out voltage, V DC (min.) (initial)	Nominal operating current, mA (±10%)	Coil resistance, Ω (±10%)	Nominal operating power, mW	Max. allowable voltage, V DC
	Standard PC board terminal	Self-clinching terminal						
1.5	TXD2-1.5V	TXD2-H-1.5V	1.13	0.15	132.7	11	200	1.8
3	TXD2-3V	TXD2-H-3V	2.25	0.3	66.7	45	200	3.6
4.5	TXD2-4.5V	TXD2-H-4.5V	3.38	0.45	44.4	101	200	5.4
5	TXD2-5V	TXD2-H-5V	3.75	0.5	40.0	125	200	6
6	TXD2-6V	TXD2-H-6V	4.5	0.6	33.3	180	200	7.2
9	TXD2-9V	TXD2-H-9V	6.75	0.9	22.2	405	200	10.8
12	TXD2-12V	TXD2-H-12V	9	1.2	16.7	720	200	14.4
24	TXD2-24V	TXD2-H-24V	18	2.4	9.6	2,504	230	28.8

2. 1 coil latching

Coil Rating, V DC	Part No.		Set voltage, V DC (max.) (initial)	Reset voltage, V DC (max.) (initial)	Nominal operating current, mA (±10%)	Coil resistance, Ω (±10%)	Nominal operating power, mW	Max. allowable voltage, V DC
	Standard PC board terminal	Self-clinching terminal						
1.5	TXD2-L-1.5V	TXD2-L-H-1.5V	1.13	1.13	100.0	15	150	1.8
3	TXD2-L-3V	TXD2-L-H-3V	2.25	2.25	50.0	60	150	3.6
4.5	TXD2-L-4.5V	TXD2-L-H-4.5V	3.38	3.38	33.3	135	150	5.4
5	TXD2-L-5V	TXD2-L-H-5V	3.75	3.75	30.0	166	150	6
6	TXD2-L-6V	TXD2-L-H-6V	4.5	4.5	25.0	240	150	7.2
9	TXD2-L-9V	TXD2-L-H-9V	6.75	6.75	16.7	540	150	10.8
12	TXD2-L-12V	TXD2-L-H-12V	9	9	12.5	960	150	14.4
24	TXD2-L-24V	TXD2-L-H-24V	18	18	7.1	3,388	170	28.8

Standard packing: Tube: 40 pcs.; Case: 1,000 pcs.

Note: In case of 5 V transistor drive circuit, it is recommended to use 4.5 V type relay.

(2) Surface-mount terminal

1. Single side stable

Coil Rating, V DC	Part No.		Pick-up voltage, V DC (max.) (initial)	Drop-out voltage, V DC (min.) (initial)	Nominal operating current, mA ($\pm 10\%$)	Coil resistance, Ω ($\pm 10\%$)	Nominal operating power, mW	Max. allowable voltage, V DC
	Tube packing	Tape and reel packing						
1.5	TXD2S○-1.5V	TXD2S○-1.5V-Z	1.13	0.15	132.7	11	200	1.8
3	TXD2S○-3V	TXD2S○-3V-Z	2.25	0.3	66.7	45	200	3.6
4.5	TXD2S○-4.5V	TXD2S○-4.5V-Z	3.38	0.45	44.4	101	200	5.4
5	TXD2S○-5V	TXD2S○-5V-Z	3.75	0.5	40.0	125	200	6
6	TXD2S○-6V	TXD2S○-6V-Z	4.5	0.6	33.3	180	200	7.2
9	TXD2S○-9V	TXD2S○-9V-Z	6.75	0.9	22.2	405	200	10.8
12	TXD2S○-12V	TXD2S○-12V-Z	9	1.2	16.7	720	200	14.4
24	TXD2S○-24V	TXD2S○-24V-Z	18	2.4	9.6	2,504	230	28.8

2. 1 coil latching

Coil Rating, V DC	Part No.		Set voltage, V DC (max.) (initial)	Reset voltage, V DC (max.) (initial)	Nominal operating current, mA ($\pm 10\%$)	Coil resistance, Ω ($\pm 10\%$)	Nominal operating power, mW	Max. allowable voltage, V DC
	Tube packing	Tape and reel packing						
1.5	TXD2S○-L-1.5V	TXD2S○-L-1.5V-Z	1.13	1.13	100.0	15	150	1.8
3	TXD2S○-L-3V	TXD2S○-L-3V-Z	2.25	2.25	50.0	60	150	3.6
4.5	TXD2S○-L-4.5V	TXD2S○-L-4.5V-Z	3.38	3.38	33.3	135	150	5.4
5	TXD2S○-L-5V	TXD2S○-L-5V-Z	3.75	3.75	30.0	166	150	6
6	TXD2S○-L-6V	TXD2S○-L-6V-Z	4.5	4.5	25.0	240	150	7.2
9	TXD2S○-L-9V	TXD2S○-L-9V-Z	6.75	6.75	16.7	540	150	10.8
12	TXD2S○-L-12V	TXD2S○-L-12V-Z	9	9	12.5	960	150	14.4
24	TXD2S○-L-24V	TXD2S○-L-24V-Z	18	18	7.1	3,388	170	28.8

○: For each surface-mounted terminal variation, input the following letter.

SA type: A, SL type: L, SS type: S

Standard packing: Tube: 40 pcs.; Case: 1,000 pcs.

Tape and reel: 500 pcs.; Case: 1,000 pcs.

Notes: 1. Tape and reel packing symbol "Z" is not marked on the relay. "X" type tape and reel packing (picked from 1/3/4/5-pin side) is also available.

2. In case of 5 V transistor drive circuit, it is recommended to use 4.5 V type relay.

2. M.B.B. Type

(1) Standard PC board terminal and self-clinching terminal

Single side stable

Coil Rating, V DC	Part No.		Pick-up voltage, V DC (max.)	Drop-out voltage, V DC (min.)	Nominal operating current, mA ($\pm 10\%$)	Coil resistance, Ω ($\pm 10\%$)	Nominal operating power, mW	Max. allowable voltage, V DC
	Standard PC board terminal	Self-clinching terminal						
1.5	TXD2-2M-1.5V	TXD2-2M-H-1.5V	1.13	0.15	166.7	9	250	1.8
3	TXD2-2M-3V	TXD2-2M-H-3V	2.25	0.3	83.3	36	250	3.6
4.5	TXD2-2M-4.5V	TXD2-2M-H-4.5V	3.38	0.45	55.6	81	250	5.4
5	TXD2-2M-5V	TXD2-2M-H-5V	3.75	0.5	50.0	100	250	6
6	TXD2-2M-6V	TXD2-2M-H-6V	4.5	0.6	41.7	144	250	7.2
9	TXD2-2M-9V	TXD2-2M-H-9V	6.75	0.9	27.8	324	250	10.8
12	TXD2-2M-12V	TXD2-2M-H-12V	9	1.2	20.8	576	250	14.4
24	TXD2-2M-24V	TXD2-2M-H-24V	18	2.4	11.3	2,133	270	28.8

Standard packing: Tube: 40 pcs.; Case: 1,000 pcs.

(2) Surface-mount terminal

Single side stable

Coil Rating, V DC	Part No.		Set voltage, V DC (max.)	Reset voltage, V DC (min.)	Nominal operating current, mA ($\pm 10\%$)	Coil resistance, Ω ($\pm 10\%$)	Nominal operating power, mW	Max. allowable voltage, V DC
	Tube packing	Tape and reel packing						
1.5	TXD2S○-2M-1.5V	TXD2S○-2M-1.5V-Z	1.13	0.15	166.7	9	250	1.8
3	TXD2S○-2M-3V	TXD2S○-2M-3V-Z	2.25	0.3	83.3	36	250	3.6
4.5	TXD2S○-2M-4.5V	TXD2S○-2M-4.5V-Z	3.38	0.45	55.6	81	250	5.4
5	TXD2S○-2M-5V	TXD2S○-2M-5V-Z	3.75	0.5	50.0	100	250	6
6	TXD2S○-2M-6	TXD2S○-2M-6V-Z	4.5	0.6	41.7	144	250	7.2
9	TXD2S○-2M-9	TXD2S○-2M-9V-Z	6.75	0.9	27.8	324	250	10.8
12	TXD2S○-2M-12	TXD2S○-2M-12V-Z	9	1.2	20.8	576	250	14.4
24	TXD2S○-2M-24	TXD2S○-2M-24V-Z	18	2.4	11.3	2,133	270	28.8

○: For each surface-mounted terminal variation, input the following letter.

SA type: A, SL type: L, SS type: S

Standard packing: Tube: 40 pcs.; Case: 1,000 pcs.

Tape and reel: 500 pcs.; Case: 1,000 pcs.

Notes: 1. Tape and reel packing symbol "Z" is not marked on the relay. "X" type tape and reel packing (picked from 1/3/4/5-pin side) is also available.

2. In case of 5 V transistor drive circuit, it is recommended to use 4.5 V type relay.

TX-D

DIMENSIONS

mm inch

1. Standard PC board terminal and self-clinching terminal

Standard PC board terminal

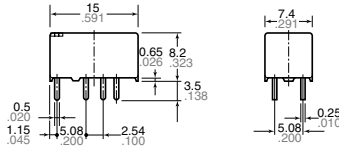

PC board pattern
(Copper side view)

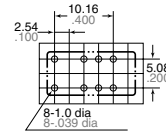

Tolerance: $\pm 0.1 \pm 0.004$

Schematic (Bottom view)
Single side stable (Deenergized condition) 1 coil latching (Reset condition)

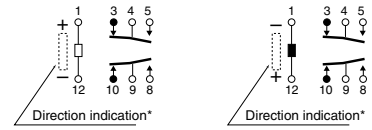

*Orientation stride located on top of relay.

Self clinching terminal

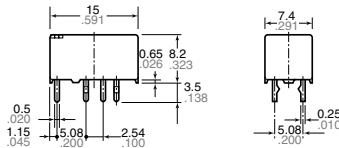

General tolerance: $\pm 0.3 \pm 0.012$

2. Surface-mount terminal

SA type

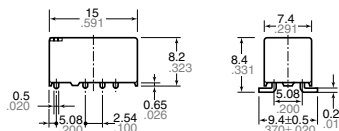

Suggested mounting pad
(Top view)

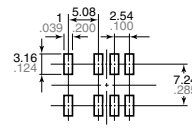

Schematic (Top view)
Single side stable (Deenergized condition) 1 coil latching (Reset condition)

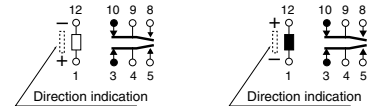

SL type

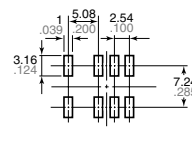
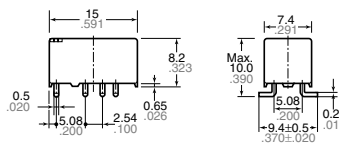

SS type

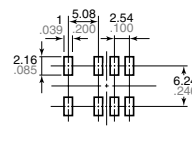
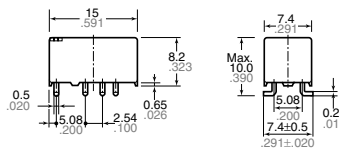

General tolerance: $\pm 0.3 \pm 0.012$

Tolerance: $\pm 0.1 \pm 0.004$

REFERENCE DATA

1. Maximum switching capacity

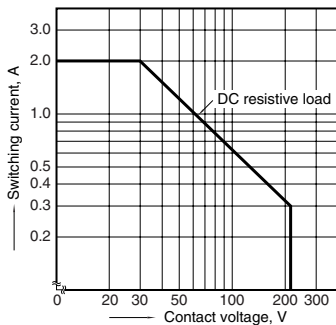

2. Life curve

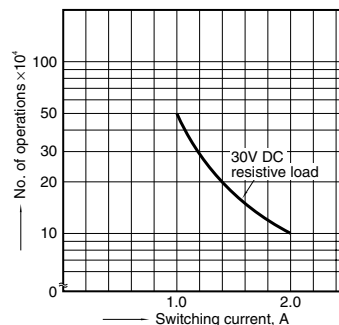

3. Mechanical life

Tested sample: TXD2-5V, 10 pcs.

Operating frequency: 180 cpm

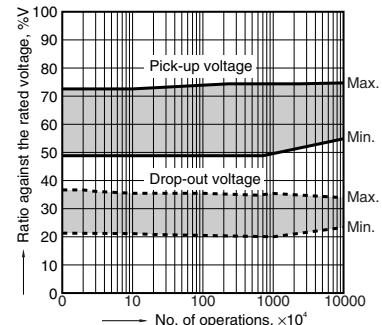

4. Electrical life (2 A 30 V DC resistive load)

Tested sample: TXD2-5V, 6 pcs.

Operating frequency: 20 cps

Change of pick-up and drop-out voltage

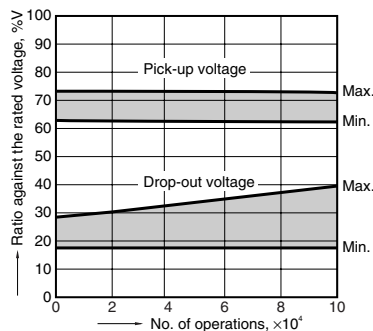

Change of contact resistance

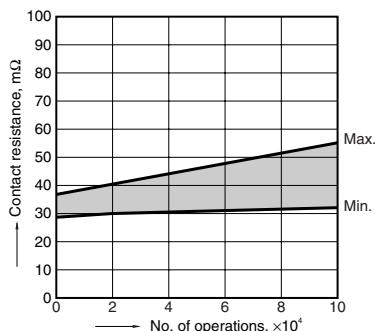

5-(1). Coil temperature rise

Tested sample: TXD2-5V, 6 pcs.

Measured portion: Inside the coil

Ambient temperature: 25°C 77°F, 70°C 158°F

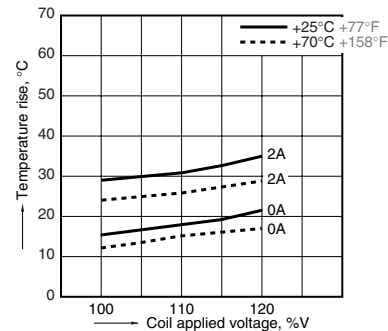

5-(2). Coil temperature rise

Tested sample: TXD2-24V, 6 pcs.

Measured portion: Inside the coil

Ambient temperature: 25°C 77°F, 70°C 158°F

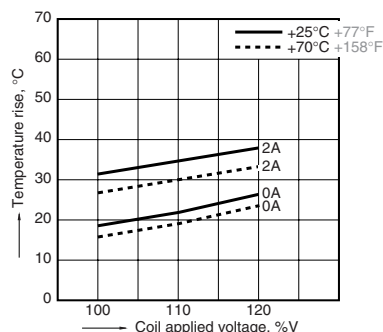

6-(1). Operate/release time characteristics (with diode)

Tested sample: TXD2-5V, 10 pcs.

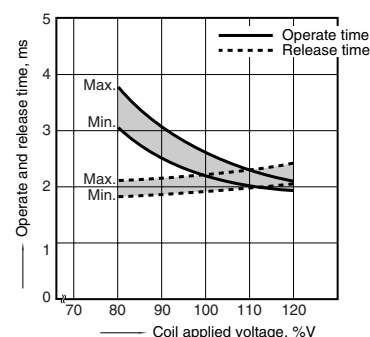

6-(2). Operate/release time characteristics (without diode)

Tested sample: TXD2-5V, 10 pcs.

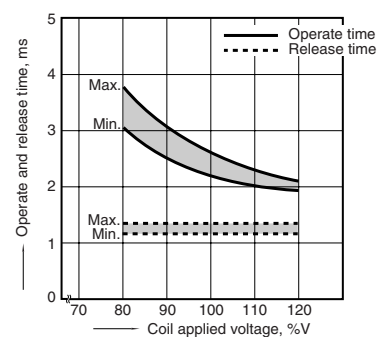

7. Distribution of pick-up and drop-out voltage

Tested sample: TXD2-5V, 50 pcs.

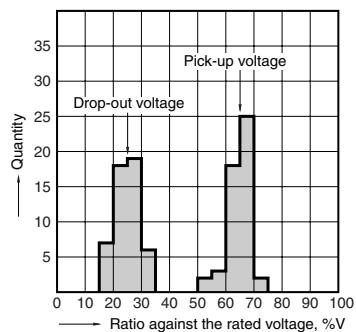

8. Distribution of set and reset voltage

Tested sample: TXD2-L-12V, 30 pcs.

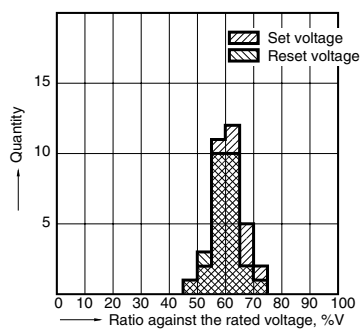

9. Ambient temperature characteristics

Tested sample: TXD2-5V, 5 pcs.

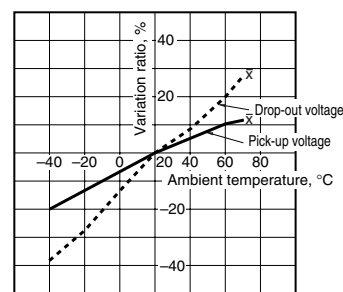

10. Distribution of contact resistance

Tested sample: TXD2-5V, 30 pcs. (30 x 4 contacts)

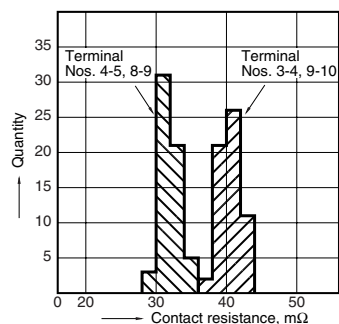

11-(1). High-frequency characteristics

Isolation characteristics

Tested sample: TXD2-12V, 2 pcs.

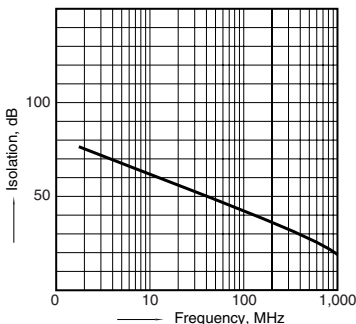

11-(2). High-frequency characteristics

Insertion loss characteristics

Tested sample: TXD2-12V, 2 pcs.

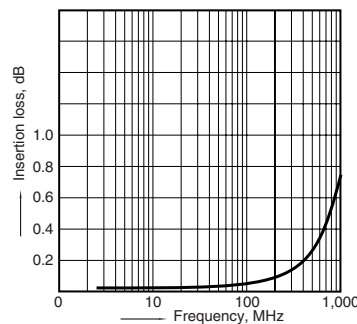

TX-D

12-(1). Malfunctional shock (single side stable)
Tested sample: TXD2-5V, 6 pcs

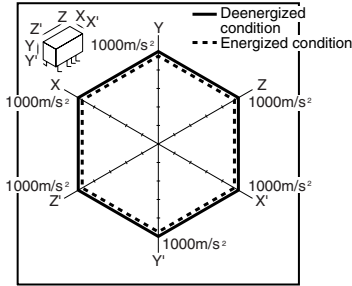

12-(2). Malfunctional shock (latching)
Tested sample: TXD2-L-12V, 6 pcs.

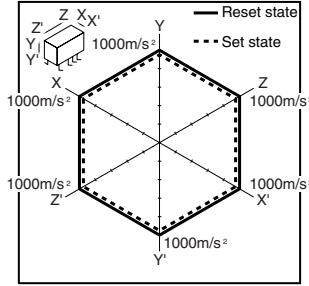

13-(1). Influence of adjacent mounting
Tested sample: TXD2-12V, 6 pcs.

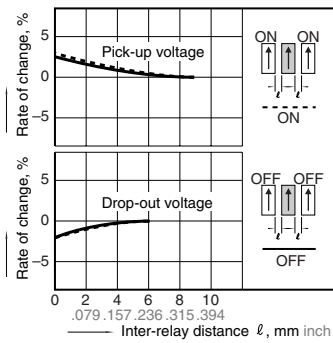

13-(2). Influence of adjacent mounting
Tested sample: TXD2-12V, 6 pcs.

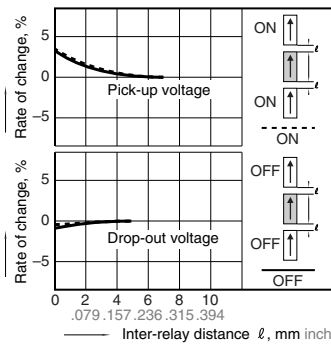

13-(3). Influence of adjacent mounting
Tested sample: TXD2-12V, 6 pcs.

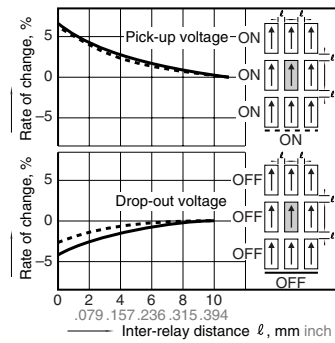

14. Actual load test (35 mA 48 V DC wire spring relay load)
Tested sample: TXD2-5V, 6 pcs.

Circuit

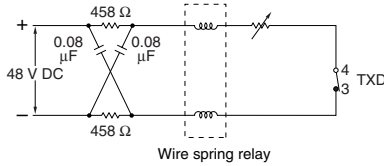

Change of pick-up and drop-out voltage

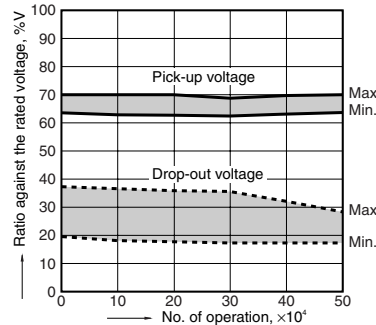

Change of contact resistance

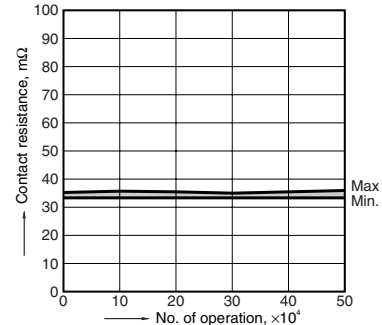

15-(1). Distribution of M.B.B. time
Tested sample: TXD2-2M-5V, 50 pcs.
Terminal No. 3-4-5: ON

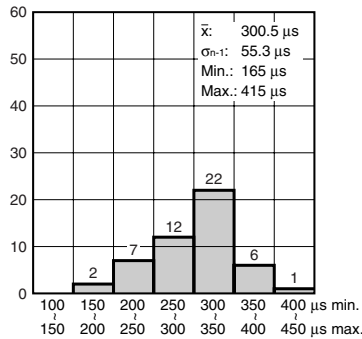

Terminal No. 3-4-5: OFF

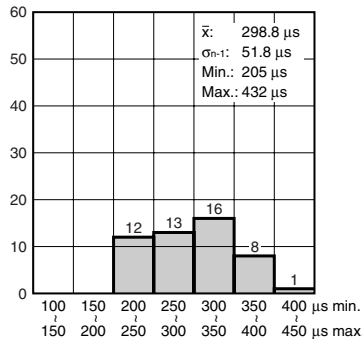

15-(2). Distribution of M.B.B. time
 Tested sample: TXD2-2M-5V, 50 pcs.
 Terminal No. 8-9-10: ON

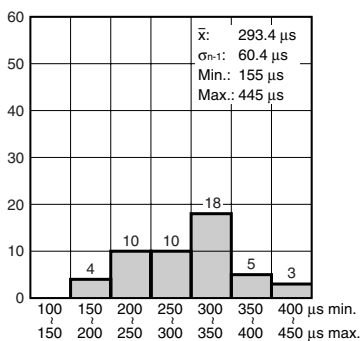

Terminal No. 8-9-10: OFF

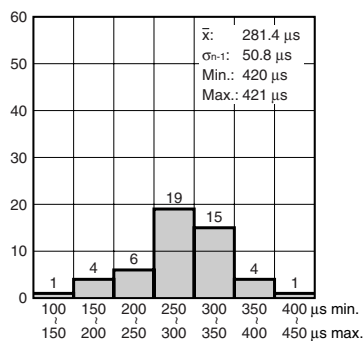

NOTES

1. Packing style

1) The relay is packed in a tube with the relay orientation mark on the left side, as shown in the figure below.

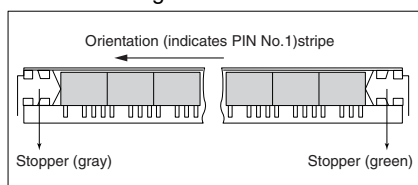

2) Tape and reel packing (surface-mount terminal type)

(1) Tape dimensions

(i) SA type

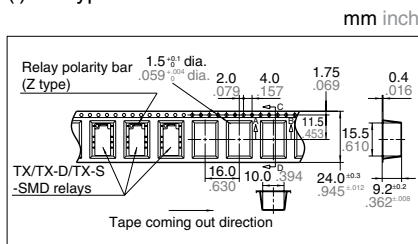

(ii) SL type

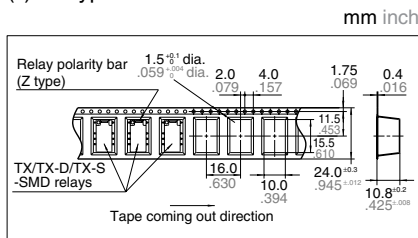

(iii) SS type

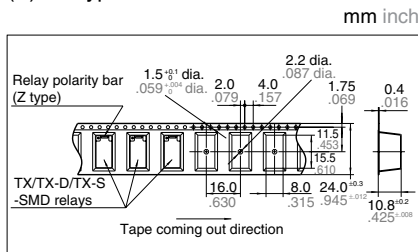

(2) Dimensions of plastic reel

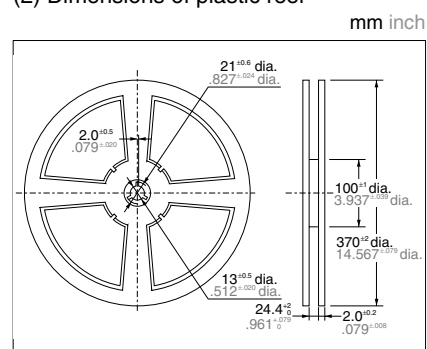

For Cautions for Use, see Relay Technical Information.