

## RU Series Universal Relays

### Full featured universal miniature relays Designed with environment taken into consideration

- Two terminal styles: plug-in and PCB mount
- Non-polarized LED indicator available on plug-in relays
- No internal wires, lead-free construction
- Cadmium-free contacts
- Mechanical flag indicator available on plug-in relays
- Manual latching lever with color coding for AC or DC coil
- Snap-on yellow marking plate; optional marking plates are available in four other colors
- Maximum contact ratings: 10A (RU2), 6A (RU4), 3A (RU42)
- UL Recognized, CSA Certified, EN Compliant



### With Latching or Momentary Lever

#### Mechanical Indicator\*

The contact position can be confirmed through the five small windows.

#### Marking Plate

Standard yellow marking plate is easily replaced with optional marking plates in four colors for easy identification of relays.

#### LED Indicator\*

Non-polarized green LED indicator is standard provision for plug-in terminal, latching lever types



#### Latching and Momentary Lever

Using the lever, operation can be checked without energizing the coil. The lever is color coded for AC and DC coils.

	Latching	Momentary
AC coil:	Orange	Red
DC coil:	Green	Blue

#### In Normal Operation



Note: Turn off the power to the relay coil when using the latching lever. After checking the operation, return the latching lever in the normal position.

### Standard (without lever)

#### AC/DC Color Marking

For identification of AC or DC coils.

AC coil: Yellow  
DC coil: Blue

#### Mechanical Indicator\*

#### Marking Plate

#### LED Indicator\*

Non-polarized green LED indicator is standard provision for plug-in terminal types.



AC Coil



DC Coil



Coil Voltage	Tape Color
24V AC	White
100 to 110V AC	Clear
110 to 120V AC	Blue
200 to 220V AC	Black
220 to 240V AC	Red
24V DC	Green
6V DC	Voltage marking on yellow tape
12V DC	
48V DC	
110V DC	



\*Not available on PCB type.

Part Number Selection

Contact	Model	Part Number			Coil Voltage Code (Standard Stock in bold)
		Standard	With Latching Lever	With Momentary Lever	
DPDT (10A) 	Standard	RU2S-C-	RU2S-	RU2S-M-	A24, <b>A110</b> , <b>A220</b> D6, D12, <b>D24</b> , D48, D110
	With RC (AC coil only)	RU2S-CR-	RU2S-R-	RU2S-MR-	A110, A220
	With diode (DC coil only)	RU2S-CD-	RU2S-D-	RU2S-MD-	D6, D12, <b>D24</b> , D48, D110
	PCB	RU2V-NF-	—	—	A24, A110, A220 D6, D12, <b>D24</b> , D48, D110
4PDT (6A) 	Standard	RU4S-C-	RU4S-	RU4S-M-	A24, <b>A110</b> , <b>A220</b> D6, D12, <b>D24</b> , D48, D110
	With RC (AC coil only)	RU4S-CR-	RU4S-R-	RU4S-MR-	A110, A220
	With diode (DC coil only)	RU4S-CD-	RU4S-D-	RU4S-MD-	D6, D12, D24, D48, D110
	PCB	RU4V-NF-	—	—	A24, <b>A110</b> , A220 D6, D12, <b>D24</b> , D48, D110
4PDT Bifurcated (3A) 	Standard	RU42S-C-	RU42S-	RU42S-M-	A24, A110, A220 D6, D12, <b>D24</b> , D48, D110
	With RC (AC coil only)	RU42S-CR-	RU42S-R-	RU42S-MR-	A110, A220
	With diode (DC coil only)	RU42S-CD-	RU42S-D-	RU42S-MD-	D6, D12, D24, D48, D110
	PCB	RU42V-NF-	—	—	A24, A110, A220 D6, D12, <b>D24</b> , D48, D110

- 1. Plug-in terminal models have an LED indicator and a mechanical indicator as standard.
- 2. PCB models do not have an LED indicator or a mechanical indicator.

**Ordering Information**  
 When ordering, specify the Part No. and coil voltage code:  
 (example) **RU2S-C** **A110**  
Part No.      Coil Voltage Code

Coil Voltage Table

Coil Voltage Code	A24	A110	A220	D6	D12	D24	D48	D110
Coil Rating	24V AC	110-120V AC	220-240V AC	6V DC	12V DC	24V DC	48V DC	110V DC

Sockets

Relays	Spring Clamp DIN Rail Mount	Standard DIN Rail Mount	Finger-safe DIN Rail Mount	Panel Mount	PCB Mount
RU2S (DPDT)	SU2S-11L	SM2S-05	SM2S-05C	SY4S-51	SM2S-61 SM2S-62
RU4S (4PDT) RU42S (4PDT)	SU4S-11L	SY4S-05	SY4S-05C		SY4S-61 SY4S-62

Switches & Pilot Lights

Display Lights



Relays & Sockets

Timers

Terminal Blocks

Circuit Breakers

**Hold Down Springs & Clips**

Appearance	Description	Relay	For DIN Mount Socket	For Through Panel & PCB Mount Socket	Min Order Qty
	Pullover Wire Spring	RU2S/RU4S/ RU42S	SY4S-02F1	SY4S-51F1	10
	Leaf Spring (side latch)	RU2S/RU4S/ RU42S	SFA-202	SFA-302	20
	Leaf Spring (top latch)	RU2S/RU4S/ RU42S	SFA-101	SFA-301	

**Accessories**

Name	Part Number	Color Code *	Min. Order Qty.
Marking Plate	RU9Z-P*	A (orange), G (green), S (blue), W (white), Y (yellow)	10



Specify a color code when ordering. The marking plate can be removed from the relay by inserting a flat screwdriver under the marking plate.

**Specifications**

Model (Contact)	RU2 (DPDT)	RU4 (4PDT)	RU42 (4PDT)
<b>Contact Material</b>	Silver alloy	Silver (gold clad)	Silver-nickel (gold clad)
<b>Contact Resistance</b> <sup>1</sup>	50 mΩ maximum		
<b>Minimum Applicable Load</b> <sup>2</sup>	24V DC, 5 mA (reference value)	1V DC, 1 mA	1V DC, 0.1 mA
<b>Operate Time</b> <sup>3</sup>	20 ms maximum		
<b>Release Time</b> <sup>3</sup>	20 ms maximum		
<b>Power Consumption</b>	AC: 1.1 to 1.4VA (50 Hz), 0.9 to 1.2VA (60 Hz) DC: 0.9 to 1.0W		
<b>Insulation Resistance</b>	100MΩ minimum (500V DC megger)		
<b>Dielectric Strength</b>	Between contact and coil: 2500V AC, 1 minute		
	Between contacts of different poles:		
	2500V AC, 1 minute	2000V AC, 1 minute	
<b>Operating Frequency</b>	Between contacts of the same pole: 1000V AC, 1 minute		
	Electrical: 1800 operations/h maximum Mechanical: 18,000 operations/h maximum		
<b>Vibration Resistance</b>	Damage limits: 10 to 55 Hz, amplitude 0.5 mm Operating extremes: 10 to 55 Hz, amplitude 0.5 mm		
<b>Shock Resistance</b>	Damage limits: 1000 m/s <sup>2</sup> (100G) Operating extremes: 150 m/s <sup>2</sup> (15G)		
<b>Mechanical Life</b>	AC: 50,000,000 operations DC: 100,000,000 operations		50,000,000 operations
<b>Electrical Life</b> <sup>4</sup>	See table on page 758		
<b>Operating Temperature</b> <sup>5</sup>	PCB model: -55 to +70°C (no freezing) Blade model: -55 to +60°C (no freezing)		
<b>Operating Humidity</b>	5 to 85% RH (no condensation)		
<b>Weight</b>	Approx. 35g		



1. Measured using 5V DC, 1A voltage drop method
2. Measured at operating frequency of 120 operations/min (failure rate level P, reference value)
3. Measured at the rated voltage (at 20°C), excluding contact bouncing;  
Release time of AC relays with RC: 25 ms maximum  
Release time of DC relays with diode: 40 ms maximum
4. Contact Load and Electrical Life (at ambient temperature 20°C)
5. Measured at the rated voltage.

Accessories

Description	Appearance	Use with	Part No.	Remarks
Aluminum DIN Rail (1 meter length)		All DIN rail sockets	BNDN1000	IDEC offers a low-profile DIN rail (BNDN1000). The BNDN1000 is designed to accommodate DIN mount sockets. Made of durable extruded aluminum, the BNDN1000 measures 0.413 (10.5mm) in height and 1.37 (35mm) in width (DIN standard). Standard length is 39" (1,000mm).
DIN Rail End Stop		DIN rail	BNL5	9.1 mm wide.
Replacement Hold-Down Spring Anchor		Horseshoe clip for DIN rail sockets	Y778-011	For use on DIN rail mount socket when using pullover wire hold down spring. 2 pieces included with each socket.

Coil Ratings

Rated Voltage (V)	Coil Voltage Code	Rated Current (mA) ±15% (at 20°C)		Coil Resistance (Ω) ±10% (at 20°C)	Operating Characteristics (values at 20°C)		
		50 Hz	60 Hz		Maximum Continuous Applied Voltage	Pickup Voltage	Dropout Voltage
AC (50/60 Hz)	24	A24	49.3	42.5	110%	80% maximum	30% minimum
	110-120	A110	8.4-10.0	7.1-8.2			
	220-240	A220	4.2-5.0	3.6-4.2			
DC	6	D6	155		110%	80% maximum	10% minimum
	12	D12	80				
	24	D24	44.7				
	48	D48	18				
	110	D110	8.9				

1. The rated current includes the current of the LED indicator.

Surge Suppressor Ratings

Model		Ratings
AC Coil	With RC	RC series circuit R: 20 kΩ, C: 0.033 μF
DC Coil	With Diode	Diode reverse voltage: 1000V Diode forward current: 1A

UL and c-UL Ratings

Voltage	Resistive			General Use			Horse Power Rating		
	RU2	RU4	RU42	RU2	RU4	RU42	RU2	RU4	RU42
250V AC	10A	—	3A	—	6A	—	—	1/10HP	—
30V DC	10A	6A	3A	—	—	—	—	—	—

Contact Ratings

Maximum Contact Capacity						
Contact	Continuous Current	Allowable Contact Power		Voltage (V)	Rated Load	
		Resistive Load	Inductive Load		Res. Load	Ind. Load
DPDT	10A	2500VA AC	1250VA AC	250 AC	10A	5A
		300W DC	150W DC	30 DC	10A	5A
4PDT	6A	1500VA AC	600VA AC	250 AC	3A	0.8A
		180W DC	90W DC	30 DC	3A	1.5A
4PDT bifurcated	3A	750VA AC	200VA AC	250 AC	3A	0.8A
		90W DC	45W DC	30 DC	3A	1.5A

1. On 4PDT relays, the maximum allowable total current of neighboring two poles is 6A. At the rated load, make sure that the total current of neighboring two poles does not exceed 6A (3A + 3A = 6A).  
2. Inductive load for the rated load — cos φ = 0.3, L/R = 7 ms

CSA Ratings

Voltage	Resistive
	RU42
250V AC	3A
30V DC	3A

TÜV Ratings

Voltage	Resistive			Inductive		
	RU2	RU4	RU42	RU2	RU4	RU42
250V AC	10A	6A	3A	5A	0.8A	0.8A
30V DC	10A	6A	3A	5A	1.5A	1.5A

Switches & Pilot Lights

Display Lights

Relays & Sockets

Timers

Terminal Blocks

Circuit Breakers

**Socket Specifications**

	Sockets	Terminal	Electrical Rating	Wire Size	Torque
DIN Rail Mount Sockets	SU2S-11L	Spring clamp terminals	250V/10A	24-16 AWG	—
	SU4S-11L	Spring clamp terminals	250V/6A (using RU4), 10A (using RU2)	24-16 AWG	—
	SM2S-05	M3 screw with captive wire clamp	300V, 10A	Maximum up to 2-#14AWG	5.5 - 9in•lbs
	SM2S-05C	M3 screw with captive wire clamp, fingersafe	300V, 10A	Maximum up to 2-#14AWG	5.5 - 9in•lbs
	SY4S-05	M3 screw with captive wire clamp	300V, 7A (using RU4), 10A (using RU2)	Maximum up to 2-#14AWG	5.5 - 9in•lbs
	SY4S-05C	M3 screw with captive wire clamp, fingersafe	300V, 7A (using RU4), 10A (using RU2)	Maximum up to 2-#14AWG	5.5 - 9in•lbs
Through Panel Mount Socket	SY4S-51	Solder	300V, 7A	—	—
PCB Mount Socket	SY4S-61	PCB mount	300V, 7A	—	—
	SY4S-62	PCB mount	250V, 7A	—	—

**Electrical Life Curves**

**RU2 (Resistive Load)**

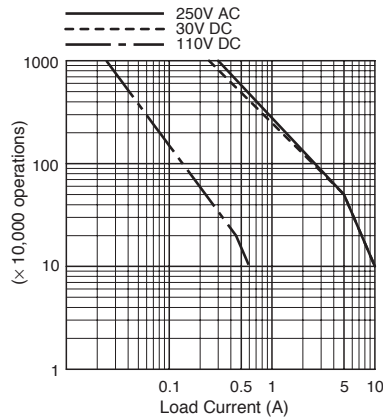

**RU4 (Resistive Load)**

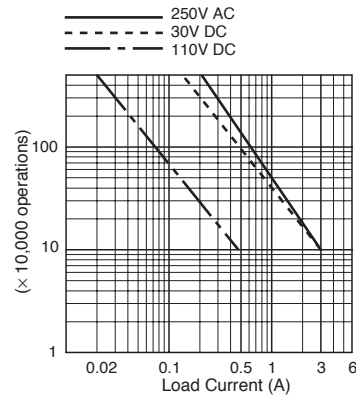

**RU42 (Resistive Load)**

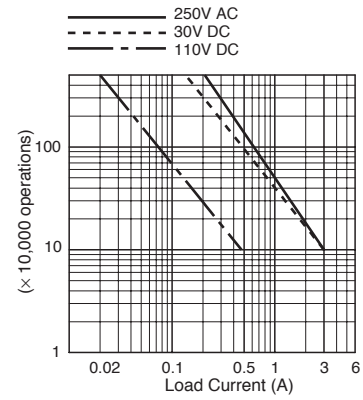

**RU2 (Inductive Load)**

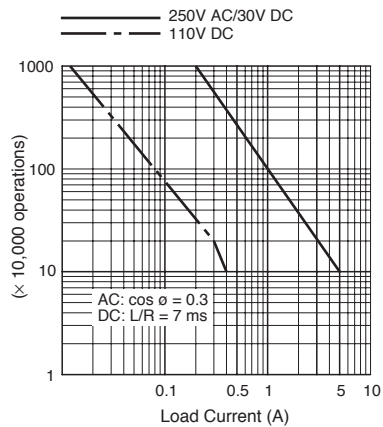

**RU4 (Inductive Load)**

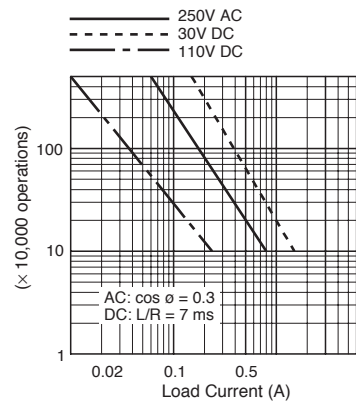

**RU42 (Inductive Load)**

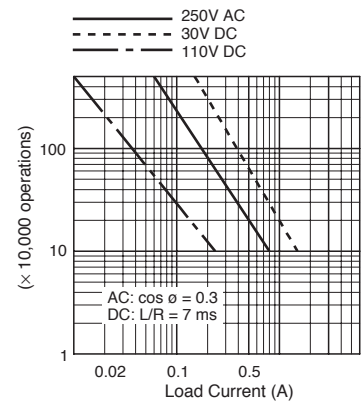

**Maximum Switching Current**

**RU2**

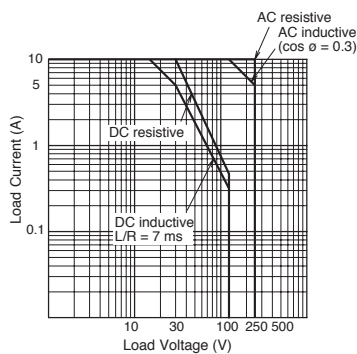

**RU4**

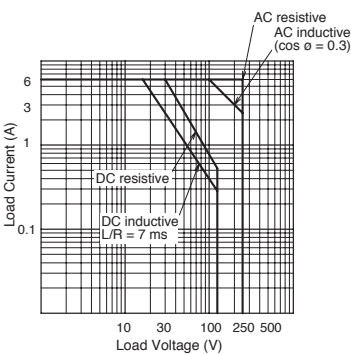

**RU42 (Bifurcated)**

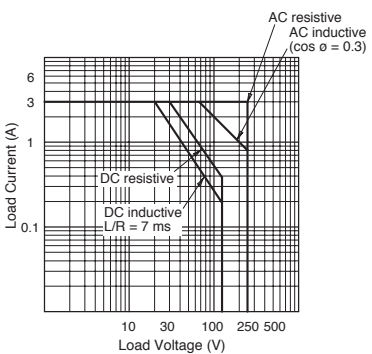

Ambient Temperature vs. Temperature Rise Curves

RU2 (AC Coil, 50 Hz)

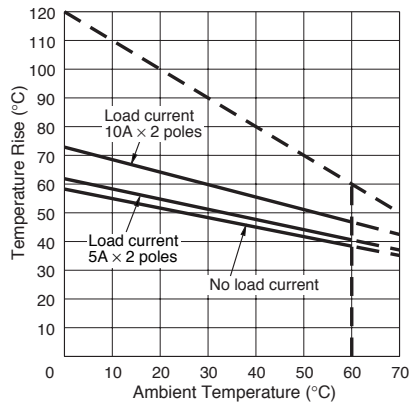

RU2 (AC Coil, 60 Hz)

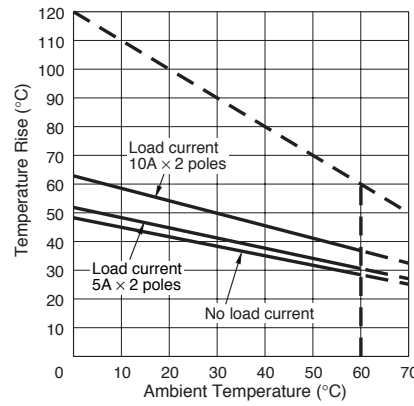

RU2 (DC Coil)

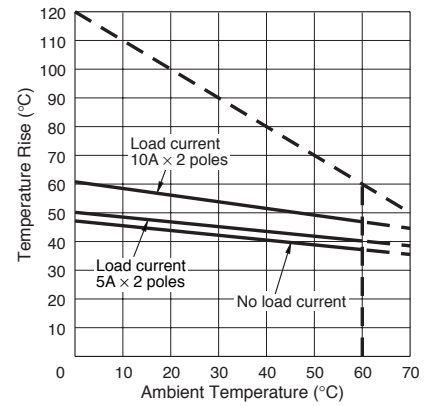

RU4/RU42 (AC Coil, 50 Hz)

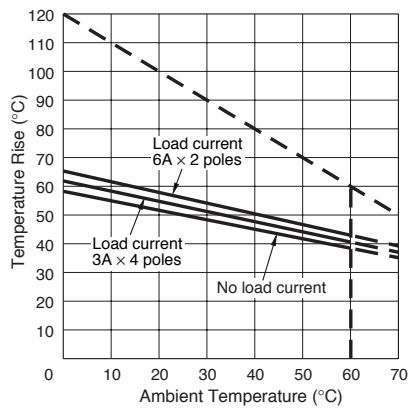

RU4/RU42 (AC Coil, 60 Hz)

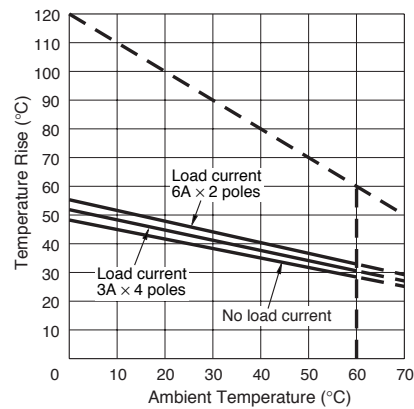

RU4/RU42 (DC Coil)

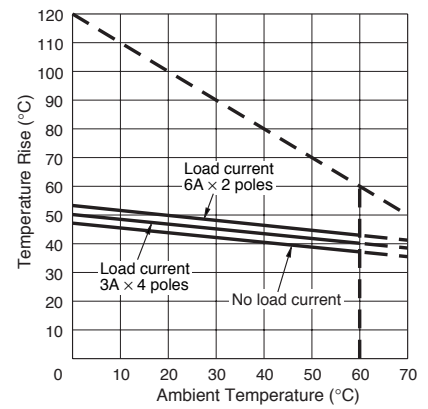

The above temperature rise curves show the characteristics when 100% the rated coil voltage is applied. The heat resistance of the coil is 120°C. The slant dashed line indicates the allowable temperature rise for the coil at different ambient temperatures. Load current 6A x 2 poles is for the RU4 models only.

**Internal Connection (View from Bottom)**

**RU2S-\* Standard**

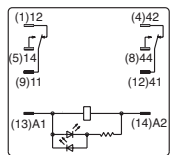

24V AC/DC coil or less

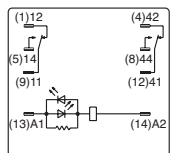

Over 24V AC/DC coil

**RU2S-\*R with RC**

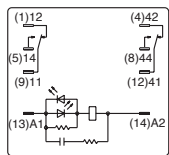

**RU2S-\*D With Diode**

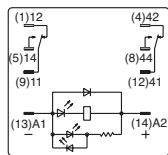

24V DC coil or less

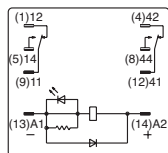

Over 24V DC coil

**RU2V-NF-\***

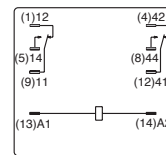

**RU4S-\*/RU42S-\* Standard**

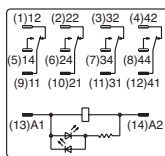

24V AC/DC coil or less

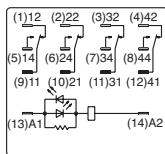

Over 24V AC/DC coil

**RU4S-\*R/RU42S-\*R With RC**

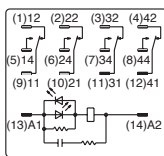

**RU4S-\*D/RU42S-\*D With Diode**

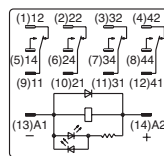

24V DC coil or less

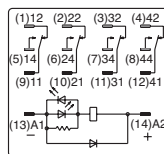

Over 24V DC coil

**RU4V-NF-\*/RU42V-NF-\***

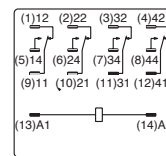

**Dimensions (mm)**

**RU2S**

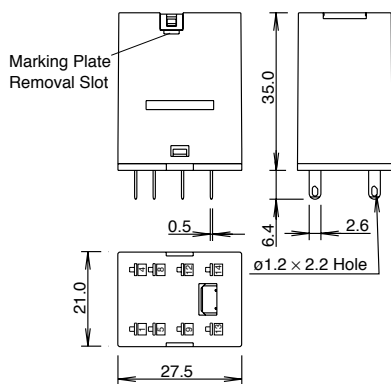

**RU2V**

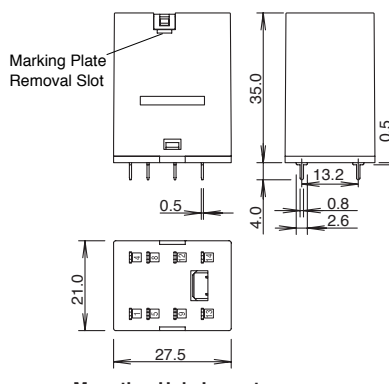

**Mounting Hole Layout**

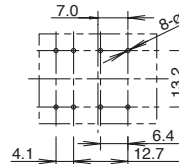

All dimensions in mm.

Marking plate removal slot is provided only on one side. Insert a flat screwdriver into the slot to remove the marking plate.

Switches & Pilot Lights

Display Lights

Relays & Sockets

Timers

Terminal Blocks

Circuit Breakers

Dimensions con't (mm)

RU4S

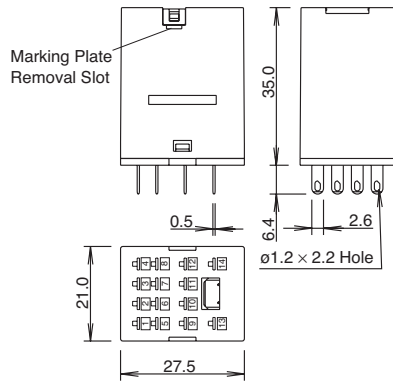

Marking plate removal slot is provided only on one side. Insert a flat screwdriver into the slot to remove the marking plate.

RU4V, RU42V

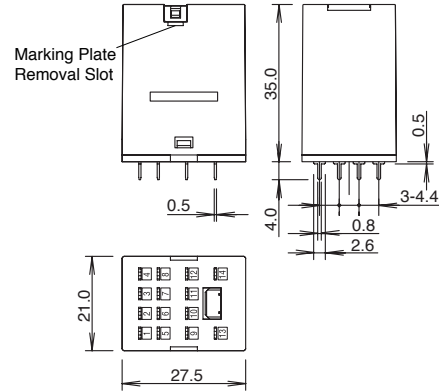

Mounting Hole Layout

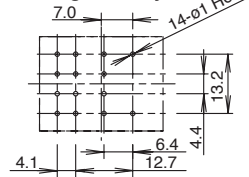

All dimensions in mm.

Spring Clamp DIN Rail Mount Sockets

SU2S-11L

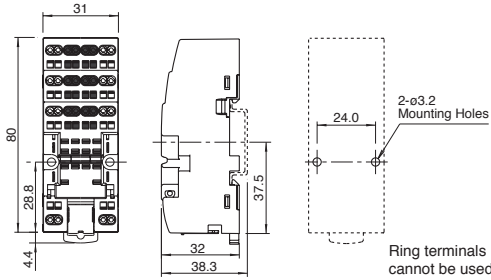

SU4S-11L

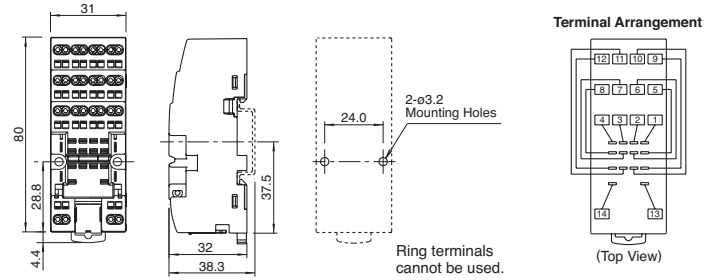

Standard DIN Rail Mount Sockets

SM2S-05

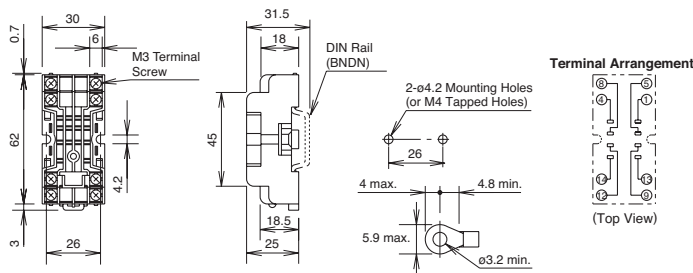

SY4S-05

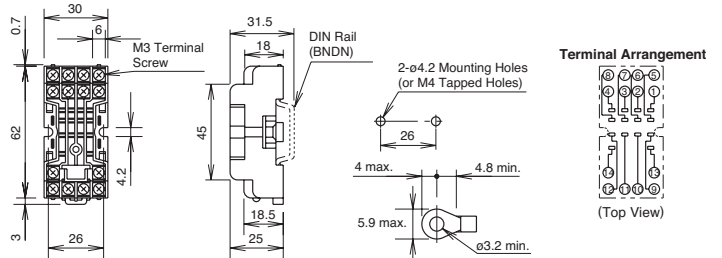



Dimensions con't (mm)

Finger-safe DIN Rail Mount Sockets

SM2S-05C

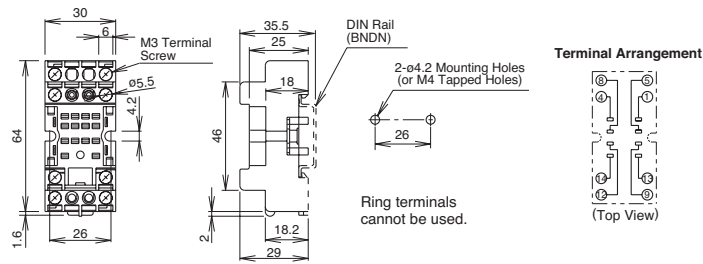

SY4S-05C

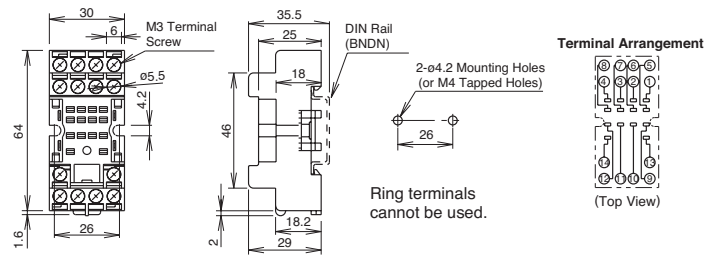

PCB Mount Sockets

SM2S-61

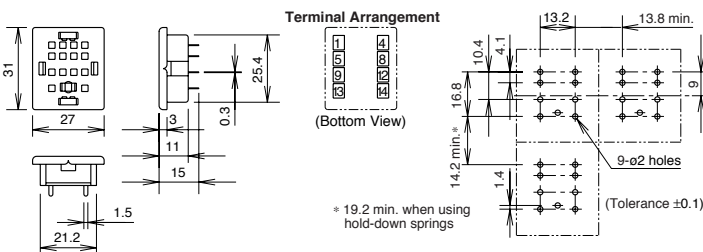

SM2S-62

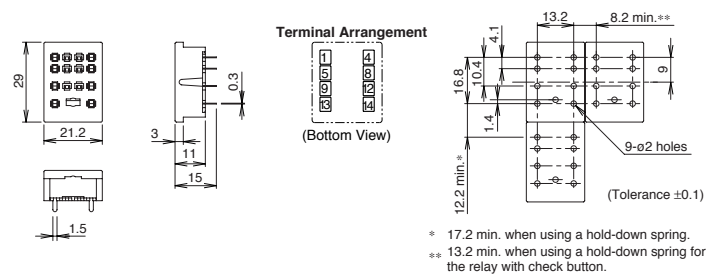

SY4S-61

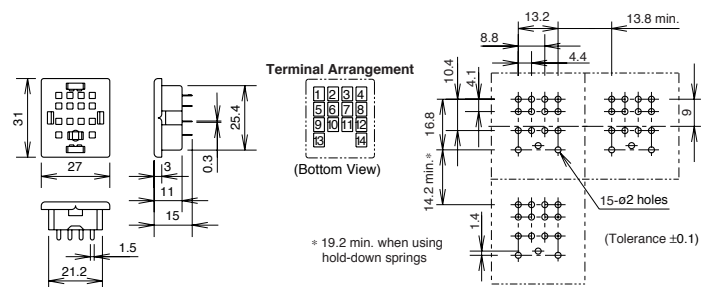

SY4S-62

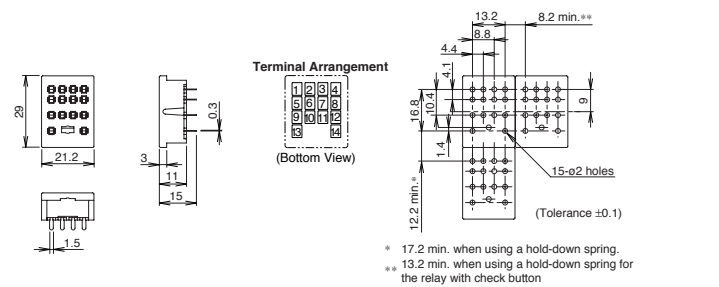

Through Panel Mount Socket

SY4S-51

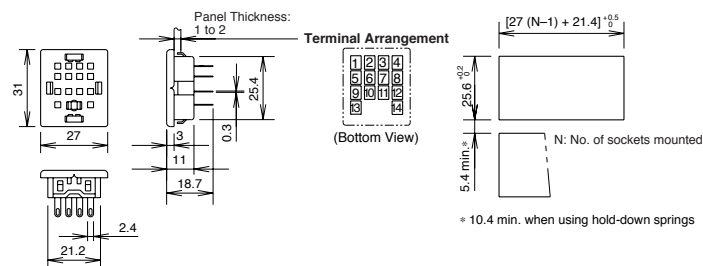

Switches & Pilot Lights

Display Lights

Relays & Sockets

Timers

Terminal Blocks

Circuit Breakers

Operating Instructions

Driving Circuit for Relays

- To ensure correct relay operation, apply rated voltage to the relay coil.
- Input voltage for the DC coil:  
A complete DC voltage is best for the coil power to make sure of stable relay operation. When using a power supply containing a ripple voltage, suppress the ripple factor within 5%. When power is supplied through a rectification circuit, the relay operating characteristics, such as pickup voltage and dropout voltage, depend on the ripple factor. Connect a smoothing capacitor for better operating characteristics as shown below.

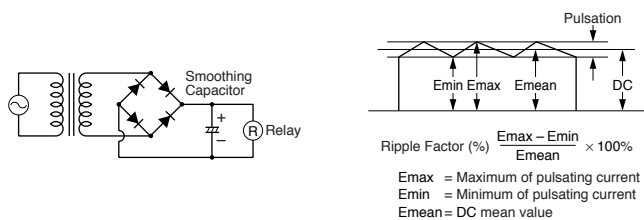

- Leakage current while relay is off:  
When driving an element at the same time as the relay operation, special consideration is needed for the circuit design. As shown in the incorrect circuit below, leakage current ( $I_0$ ) flows through the relay coil while the relay is off. Leakage current causes coil release failure or adversely affects the vibration resistance and shock resistance. Design a circuit as shown in the correct example.

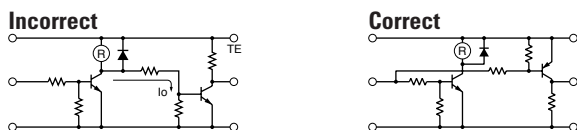

- Surge suppression for transistor driving circuits:  
When the relay coil is turned off, a high-voltage pulse is generated, causing a transistor to deteriorate and sometimes to break. Be sure to connect a diode to suppress the back electromotive force. Then, the coil release time becomes slightly longer. To shorten the coil release time, connect a Zener diode between the collector and emitter of the transistor. Select a Zener diode with a Zener voltage slightly higher than the power voltage.

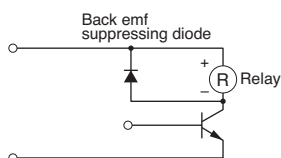

Protection for Relay Contacts

- The contact ratings show maximum values. Make sure that these values are not exceeded. When an inrush current flows through the load, the contact may become welded. If this is the case, connect a contact protection circuit, such as a current limiting resistor.
- Contact protection circuit:  
When switching an inductive load, arcing causes carbides to form on the contacts, resulting in increased contact resistance. In consideration of contact reliability, contact life, and noise suppression, use of a surge absorbing circuit is recommended. Note that the release time of the load becomes slightly longer. Check the operation using the actual load. Incorrect use of a contact protection circuit will adversely affect switching characteristics. Four typical examples of contact protection circuits are shown in the following table:

<b>RC</b>		This protection circuit can be used when the load impedance is smaller than the RC impedance in an AC load power circuit. • R: Resistor of approximately the same resistance value as the load • C: 0.1 to 1 $\mu$ F
<b>Diode</b>		This protection circuit can be used for DC load power circuits. Use a diode with the following ratings. Reverse withstand voltage: Power voltage of the load circuit x 10 Forward current: More than the load current
<b>Varistor</b>		This protection circuit can be used for both AC and DC load power circuits. For a best result, when using a power voltage of 24 to 48V AC/DC, connect a varistor across the load. When using a power voltage of 100 to 240V AC/DC, connect a varistor across the contacts.

- Do not use a contact protection circuit as shown below:

	This protection circuit is very effective in arc suppression when opening the contacts. But, the capacitor is charged while the contacts are opened. When the contacts are closed, the capacitor is discharged through the contacts, increasing the possibility of contact welding.
	This protection circuit is very effective in arc suppression when opening the contacts. But, when the contacts are closed, a current flows to charge the capacitor, causing contact welding.

Generally, switching a DC inductive load is more difficult than switching a DC resistive load. Using an appropriate arc suppressor, however, will improve the switching characteristics of a DC inductive load.

Soldering

- When soldering the relay terminals, use a soldering iron of 30 to 60W, and quickly complete soldering (within approximately 3 seconds).
- Use a non-corrosive rosin flux.

Switches & Pilot Lights

Display Lights

Relays & Sockets

Timers

Terminal Blocks

Circuit Breakers

## Operating Instructions con't

## Other Precautions

1. General notice:  
To maintain the initial characteristics, do not drop or shock the relay.  
  
The relay cover cannot be removed from the base during normal operation. To maintain the initial characteristics, do not remove the relay cover.  
  
Use the relay in environments free from condensation, dust, sulfur dioxide (SO<sub>2</sub>), and hydrogen sulfide (H<sub>2</sub>S).  
  
Make sure that the coil voltage does not exceed applicable coil voltage range.
2. UL and CSA ratings may differ from product rated values determined by IDEC.
3. Do not use relays in the vicinity of strong magnetic field, as this may affect relay operation.

## Safety Precautions

- Turn off the power to the relay before starting installation, removal, wiring, maintenance, and inspection of the relays. Failure to turn power off may cause electrical shock or fire hazard.
- Observe specifications and rated values, otherwise electrical shock or fire hazard may be caused.
- Use wires of the proper size to meet voltage and current requirements. Tighten the terminal screws on the relay socket to the proper tightening torque.
- Surge absorbing elements on AC relays with RC or DC relays with diode are provided to absorb the back electromotive force generated by the coil. When the relay is subject to an excessive external surge voltage, the surge absorbing element may be damaged. Add another surge absorbing provision to the relay to prevent damage.

## Precautions for the RU Relays

- Before operating the latching lever of the RU relay, turn off the power to the RU relay. After checking the circuit, return the latching lever to the original position.
- Do not use the latching lever as a switch. The durability of the latching lever is a minimum of 100 operations.
- When using DC loads on 4PDT relays, apply a positive voltage to terminals of neighboring poles and a negative voltage to the other terminals of neighboring poles to prevent the possibility of short circuits.
- DC relays with a diode have a polarity in the coil terminals. Apply the DC voltage to the correct terminals.