

Power Supplies



Selection Guide.....	106
PS5R Slim Line Series	107
NEW Part Numbers	108
Specifications.....	109
Dimensions and Terminal Markings	111
PS5R Standard Series	113
Part Numbers	113
Specifications.....	114
Dimensions	117
Terminal Markings	117
PS3L Series	118
Specifications.....	119
Dimensions	123
Safety Precautions	126















For more information on this product family, visit our website.

Additional resources include:

- New and updated product information
- Downloadable software demos & upgrades
- Part configuration tool & cross reference
- Online stock check & ordering
- IDEC field sales & distributor search
- Online literature request
- Downloadable manuals & CAD drawings
- Manufacturer's suggested retail price list
- Product training schedule & locations
- Advertising & trade show schedules
- Press releases & FAQs

www.idec.com/powersupplies

Selection Guide

		PS5R Slim Line	PS5R	PS3L
Appearance				
Page		107	113	118
Housing		Plastic		Metal
Mounting		DIN Rail or surface mount		Panel or bracket mount
Wattage Range		10W to 240W	7.5W to 240W	10W to 300W
Input Voltage		85 to 264 V AC, 100-370 V DC (100-350V DC, 120W & 240W)	85 to 264V AC, 105 to 370V DC	85 to 264V AC, 105 to 370V DC
Output Current Ratings	5VDC	2.0A	1.5A, 2.5A	2A, 3A, 6A
	12VDC	1.2A, 2.5A	0.6A, 1.2A, 2.5A	0.90A, 1.4A, 2.5A, 4.3A, 8.5A, 13A
	24VDC	0.65A, 1.3A, 2.5A, 3.75A, 5A, 10A	0.30A, 0.60A, 1.3A, 2.1A, 3.1A, 4.2A, 5A, 10A	0.50A, 0.70A, 1.3A, 2.2A, 4.5A, 6.5A, 12.5A
Typical Efficiency	5VDC	69%	69%	70-75%
	12VDC	75%, 78%	73% to 75%	74% to 80%
	24VDC	80% to 84%	75% to 85%	78% to 82%
Voltage Adjustments		+/-10% (V.ADJ control on front)		
Ripple Voltage		2% peak to peak max (including noise)		160mV maximum
Overvoltage Protection (input)		120% or more, auto reset	120% typical	
Overcurrent Protection (output)		105% min shutdown	105% minimum (Zener or auto reset)	
Operating Temperature		-10° to +60°C (14° to 140°F)		
Termination		M3.5 phillip/slotted, spring loaded, captive (fingersafe)		IEC Style screw terminals (fingersafe)
Approvals		  UL1604 Listed File#E234997   (SEMI F47 120W & 240W only)	  UL508 Listed File #E177168  Cert No. BL980213332392	  UL508 Listed File #E177168 

PLCs

Operator Interfaces

Automation Software

Power Supplies

Sensors

Communication & Networking

PS5R Slim Line Series Switching Power Supplies

Key features of the PS5R Slim Line series include:

- Lightweight and compact in size
- Wide power range: 10W-240W
- Universal input:
10W to 90W: 85-264V AC/100-370V DC
120W and 240W: 85-264V AC/100-350V DC
- Power Factor Correction for 60W to 240W (EN61000-3-2)
- Meets SEMI F47 Sag Immunity (120W & 240W only)
- Approved for Class 1, Div. 2 Hazardous Locations
- Overcurrent protection, auto-reset
- Overvoltage protection, shut down
- Spring-up screw terminal type, IP20
- DIN rail or panel surface mount
- Approvals:
CE Marked
TÜV
c-UL, UL508
UL1310 (PS5R-SB, -SC, -SD)



UL1604 (Hazardous locations)
EN50178:1997
LVD: EN60950:2000
EMC: Directive EN61204-3:2000 (EMI: Class B, EMS: Industrial)



Designed with Accessibility & Convenience in Mind!

DC Low Indicator (15W, 120W & 240W Slim Line Only)

The indicator turns on when the output voltage drops below 80% of the rated value. This assists in troubleshooting power supply problems.

DC ON Indicator

The indicator turns on when the unit is powered up. This is a convenient way to know when the power supply is receiving power.

Output Voltage Adjustment

The output voltage can be easily adjusted within $\pm 10\%$ of the rated voltage.



Fingersafe, Spring-up Screw Terminals

Don't worry about losing screws or getting an inadvertent shock from a terminal. The terminals are captive spring-up screws, which makes using them as easy as pushing a screw down and tightening it. They are shock and vibration resistant, and work with ring lugs, fork connectors or stripped wire connections. The terminals are rated IP20 (when tightened) meaning they are recessed to keep fingers and objects from touching the input contacts.

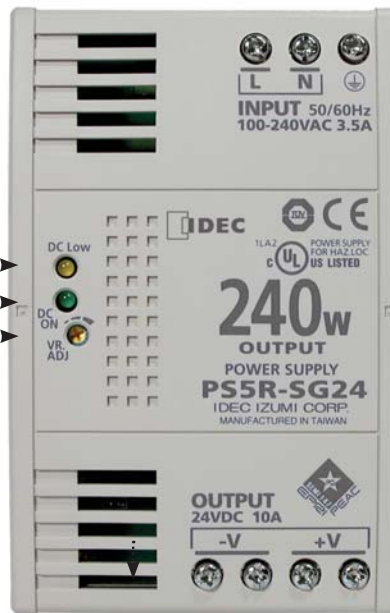

Universal Input Power

The applied input power has a range of 85-264V AC (100-350V DC) without the use of jumpers or slide switches. This makes IDEC power supplies suitable for use anywhere in the world.

Long Life Expectancy

IDEC power supplies are very reliable, with a life expectancy of 70,000 hrs. (minimum) or longer, depending on usage. Power factor correction has also been included to minimize harmonic distortion, resulting in a longer operating life and increased reliability.

Output Channel

With very low output ripples of less than 1% peak to peak, the 120W and 240W power supplies are some of the best in the industry. The output comes with overload protection that avoids damaging the power supply and the spring-up, fingersafe, screw terminals add a level of safety and ease for the user. The 240W power supply also has the convenience of two output terminals.

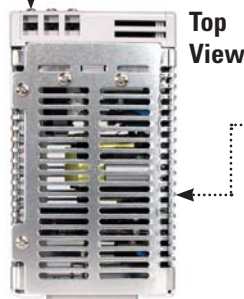

Ventilation Grill

Provides cooling for the power supply and prevents small objects from falling into the power supply circuitry.

PLCs

Operator Interfaces







Automation Software

Power Supplies



Sensors

Communication & Networking

Part Numbers

Item	Watts	Rated Voltage	Rated Current	Part Number	Item	Watts	Rated Voltage	Rated Current	Part Number	
 PLCs	10	5V DC	2.0A	PS5R-SB05	 Operator Interfaces	90	24V DC	3.75A	PS5R-SE24	
	15	12V DC	1.2A	PS5R-SB12		 Automation Software	120	24V DC	5A	PS5R-SF24
		24V DC	0.65A	PS5R-SB24			 Power Supplies	240	24V DC	10A
 Operator Interfaces	30	12V DC	2.5A	PS5R-SC12	 Automation Software	60		24V DC	2.5A	PS5R-SD24
		24V DC	1.3A	PS5R-SC24						

Accessories

Appearance	Description	Part Number
 Sensors	Panel Mounting Bracket for PS5R-SB	PS9Z-5R1B
	Panel Mounting Bracket for PS5R-SB (flat side mounting)	PS9Z-5R2B
	Panel Mounting Bracket for PS5R-SC and PS5R-SD	PS9Z-5R1C
	Panel Mounting Bracket for PS5R-SE	PS9Z-5R1E
	Panel Mounting Bracket for PS5R-SF & PS5R-SG	PS9Z-5R1G
 Communication & Networking	DIN rail (1000mm)	BNDN1000
 Communication & Networking	DIN rail end clip	BNL5

Specifications

Part Numbers	5V DC output	PS5R-SB05	–	–	–	–	–	
	12V DC output	PS5R-SB12	PS5R-SC12	–	–	–	–	
	24V DC output	PS5R-SB24	PS5R-SC24	PS5R-SD24	PS5R-SE24	PS5R-SF24	PS5R-SG24	
Output Capacity		15W (5V Model is 10W)	30W	60W	90W	120W	240W	
Input	Input Voltage (single-phase, 2-wire)	85 to 264V AC, 100 to 370V DC				85 to 264V AC, 100 to 350V DC		
	Input Current (maximum)	100VAC	0.45A	0.9A	1.7A	2.3A	1.8A	3.5A
		200VAC	0.3A	0.6A	1.0A	1.4A	1.0A	1.7A
	Internal Fuse Rating	2A	3.15A		4A		6.3A	
	Inrush Current (cold start)	50A maximum (at 200V AC)						
	Leakage Current (at no load)	132V AC: 0.38 mA maximum 264V AC: 0.75 mA maximum		0.75mA maximum			1mA maximum	
	Typical Efficiency	5V DC	69%	–	–	–	–	–
12V DC		75%	78%	–	–	–	–	
24V DC		79%	80%	83%	82%	84%		
Output Current Ratings	5V DC	2.0A	–	–	–	–	–	
	12V DC	1.2A	2.5A	–	–	–	–	
	24V DC	0.65A	1.3A	2.5A	3.75A	5A	10A	
Voltage Adjustment		±10% (V. ADJ control on front)						
Output Holding Time		20ms minimum (at rated input and output)						
Starting Time	200ms maximum	–	–	–	650ms maximum	500ms maximum		
Rise Time	100ms maximum (at rated input and output)				200ms maximum			
Line Regulation		0.4% maximum						
Load Regulation		1.5% maximum				0.8% max		
Temperature Regulation		0.05% degree C maximum						
Ripple Voltage		2% peak to peak maximum (including noise)				1% peak to peak maximum (including noise)		
Overcurrent Protection		105% or more, auto reset			105 to 130%, auto reset		103 to 110%, auto reset	
Overvoltage Protection		120% min. SHUTDOWN						
Operation Indicator		LED (green)						
Voltage Low Indication		LED (amber)	–	–	–	LED (amber)		
Dielectric Strength		Between Input and Ground: 2000 V AC, 1 minute Between input and output: 3000V AC, 1 minute; Between output and ground: 500V AC, 1 minute.						
Insulation Resistance		Between Input & Output Terminals: 100 MΩ Min						
Operating Temperature		–10 to +65°C (14 to 149°F)		–10 to 60°C (14 to 140°F)				
Storage Temperature		–25 to 75°C (-13 to +167°F)						
Operating Humidity		20 to 90% relative humidity (no condensation)						
Vibration Resistance		Frequency 10 to 55Hz, Amplitude 0.375mm						
Shock Resistance		300m/s ² (30G) 3 times each in 6 axes						
Approvals		EMC: EN61204-3 (EMI: Class B, EMS: Industrial), c-UL (CSA 22.2 No. 14), UL1604, UL508, LVD: EN60950, EN50178 UL1310 Class 2, c-UL (CSA 22.2 No. 213 and 223)						
Harmonic Directive		N/A			EN61000-3-2 A14 class A			
Weight (approx.)		160g	250g	285g	440g	630g	1000g	
Terminal Screw		M3.5 slotted-Phillips head screw (screw terminal type)						
IP protection		IP20 fingersafe						
Dimensions H x W x D (mm)		90 x 22.5 x 95	95 x 36 x 108		115 x 46 x 121	115 x 50 x 129	125 x 80 x 149.5	
Dimensions H x W x D (inches)		3.54 x 0.89 x 3.74	3.74 x 1.42 x 4.25		4.53 x 1.81 x 4.76	4.53 x 1.97 x 5.08	4.92 x 3.15 x 5.89	

PLCs

Operator Interfaces

Automation Software

Power Supplies

Sensors

Communication & Networking



1. For dimensions, see page 111.

Temperature Derating Curves

All IDEC Slim Line power supplies are listed to UL508, which allows operation at 100% capacity inside a panel. This eliminates the need to use oversize power supplies or utilize two power supplies derated at 50% of their rated output.

The charts below show that the PS5R Slim 10W (at 60°C) and 15W (at 60°C), 30W/60W/90W (at 55°C), 120W (at 40°C), and 240W (at 45°C) meet the elevated, ambient operating temperature required by UL508 and EN60950 standards to operate at an output current of 100%. The output current starts to derate beyond the required temperature.

PS5R-SB

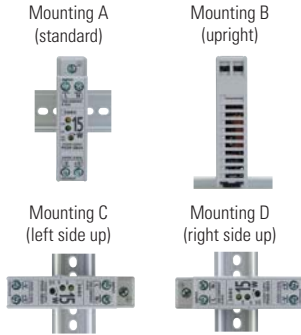
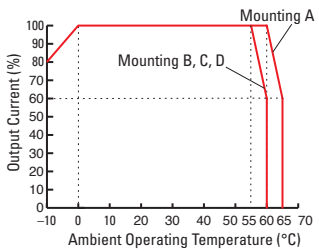

Derating curve for PS5R-SB varies depending on mounting method (see right).

PS5R-SC

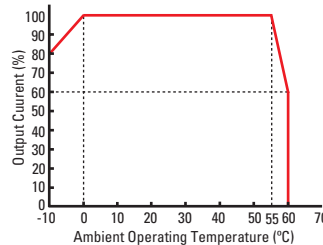

PS5R-SG

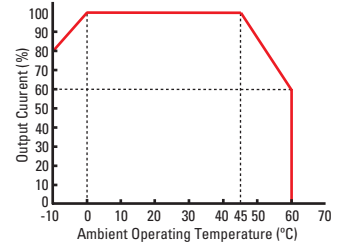

PS5R-SD, -SE, -SF

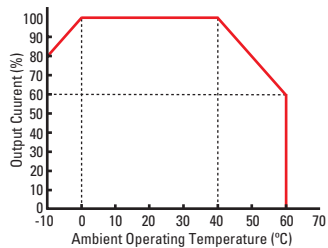

PS5R-SE 90W/3.75A/24V DC versus a Leading Competitor
Standard derating curve (operating temperature vs. output current)

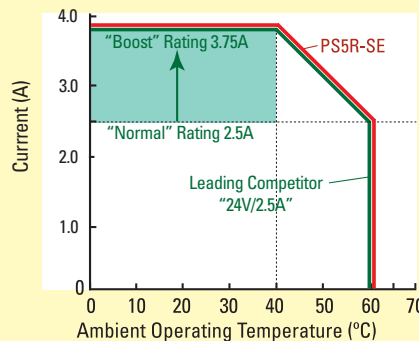

Don't Believe the Hype

Other companies use slick marketing to sell you 60W power supplies with a "BOOST," but what they don't tell you is that these are merely 90W power supplies that have been renamed to fool you into thinking they have a unique feature. IDEC 90W power supplies are just what they claim, 90W power supplies. The truth is IDEC led the market by incorporating UL508 DIN rail mount power supplies as a standard product. Don't let the other guys pull a fast one on you by claiming to provide features that just aren't true, or even possible. See what IDEC has to offer, no strings attached.

Overload Protection

Overload protection prevents the power supply from being damaged when an overload occurs. There are two kinds of protection.

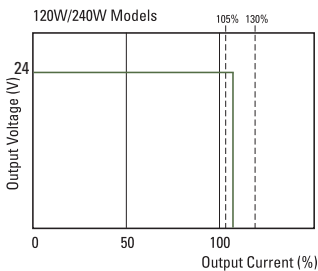

Overcurrent Protection

When the output current exceeds 105% of the rated current, overload protection is triggered, and the output voltage starts decreasing. When the output current returns within the rated range, the overload protection function is automatically cleared.

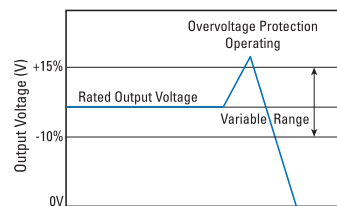

Overvoltage Protection

When the output voltage of the power supply rises to 120% or more of the rated value, the output will shut off. To restore power, only manual reset is available which is an advantage in troubleshooting.

Overcurrent Protection
PS5R-SF, -SG

Overvoltage Protection

SEMI-F47 Approved

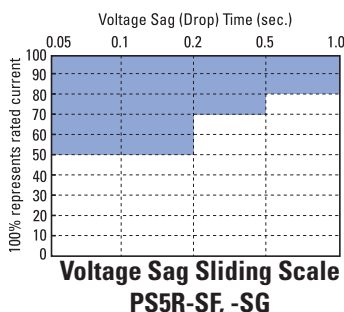

The SEMI F47 (Semiconductor Processing Equipment Voltage Sag Immunity) defines the minimum voltage sag ride-through requirements for semiconductor processing, automated test equipment, and other equipment. It requires that the equipment be able to tolerate voltage sags on an AC power line without interrupting operations. This avoids the loss of production and money.

The graph shows how the equipment must tolerate sags to 50% for 200ms, sags to 70% for up to 0.5 seconds, and sags to 80% for up to 1 second.

Dimensions and Terminal Markings

PS5R-SB

Height 90mm
Width 22.5mm
Depth 95mm

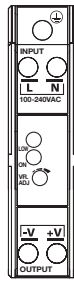

**PS5R-SC
PS5R-SD**

Height 95.0mm
Width 36.0mm
Depth 108.0mm

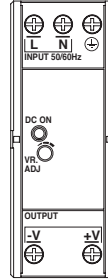

PS5R-SE

Height 115.0mm
Width 46.0mm
Depth 121.0mm

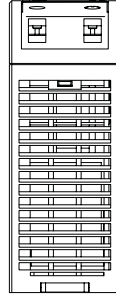
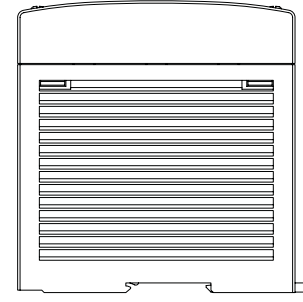
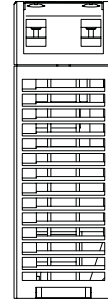
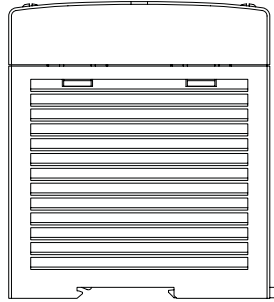
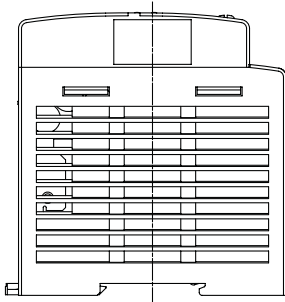
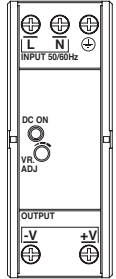

PS5R-SF

Height 115.0mm
Width 50.0mm
Depth 129.0mm

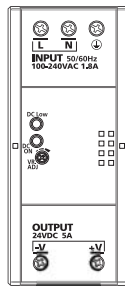

PS5R-SG

Height 125.0 mm
Width 80.0 mm
Depth 149.5 mm

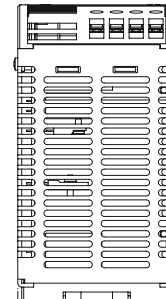
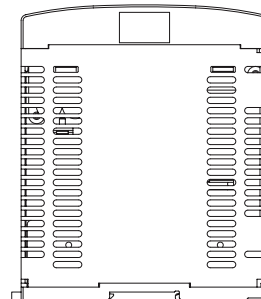
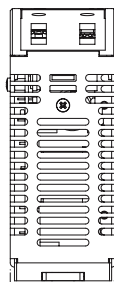
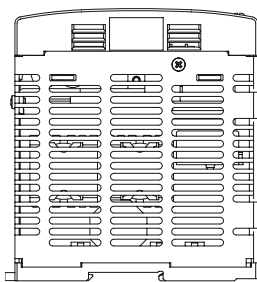
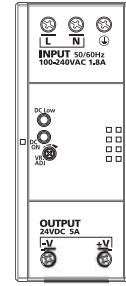

Front Panel (terminals)

Markings	Name	Description
V. ADJ	Voltage adjustment	Adjusts within $\pm 10\%$; turn clockwise to increase output voltage.
DC ON	Operation indicator	Green LED is lit when output voltage is on.
DC Low	Output indicator	Amber LED is lit when output voltage drops below 80% of rated voltage.
+V, -V	DC output terminals	+V: Positive output Terminal -V: Negative output terminal
	Frame ground	Ground this terminal to reduce high-frequency noise caused by switching power supply.
L, N	Input terminals	Accept a wide range of voltages and frequencies (no polarity at DC input).

PLCs

Operator Interfaces

Automation Software

Power Supplies

Sensors

Communication & Networking

Mounting Bracket Dimensions (mm)

PS9Z-5R1B (for PS5R-SB)

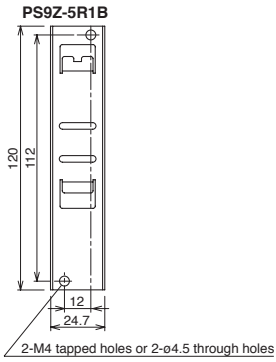

PS9Z-5R2B (for PS5R-SB)

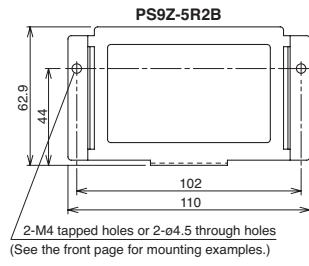

PS9Z-5R1C (for PS5R-SC & PS5R-SD)

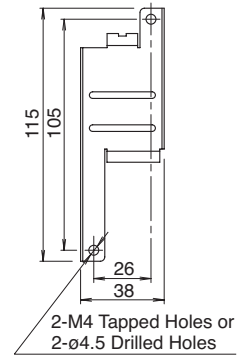

PS9Z-5R1E (for PS5R-SE)

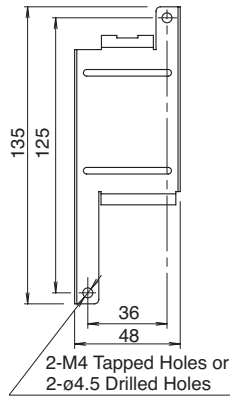

PS9Z-5R1G (for PS5R-SF & PS5R-SG)

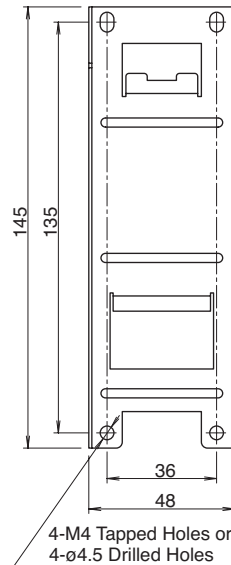

PLCs
Operator Interfaces

Automation Software

Power Supplies

Sensors

Communication & Networking

PS5R Standard Series Switching Power Supplies

Key features of the PS5R standard series include:

- Wide power range: 7.5W-240W
- Universal input :
7.5W-50W: 85-264V AC/105-370V DC
100W: 85-132V AC/170-264V AC
240-370V DC (selectable)
75W, 120W, 240W: 85-264V AC/110-350V DC
- Overcurrent/overvoltage protection
- Power Factor Correction (75W, 120W, 240W models)
EN61000-3-3
EN61000-3-2
- Voltage adjustment +10%
- Spring-up crew terminal, IP20 (finger-safe)
- DIN rail or panel surface mount
- Approvals:
CE marked
UL 508 Listed
UL, c-UL
TÜV approved
EMC Directives:
EN50081-2
EN50082-2
EN61000-6-2
LVD EN60950:2000



Part Numbers

Item	Watts	Rated Voltage	Rated Current	Part Number	Item	Watts	Rated Voltage	Rated Current	Part Number
	7.5	5V DC	1.5A	PS5R-A05		75	24V DC	3.1A	PS5R-Q24
		12V DC	0.6A	PS5R-A12					
		24V DC	0.3A	PS5R-A24					
	15	5V DC	2.5A	PS5R-B05		100	24V DC	4.2A	PS5R-E24
		12V DC	1.2A	PS5R-B12					
		24V DC	0.6A	PS5R-B24					
	30	12V DC	2.5A	PS5R-C12		120	24V DC	5A	PS5R-F24
		24V DC	1.3A	PS5R-C24					
	50	24V DC	2.1A	PS5R-D24		240	24V DC	10A	PS5R-G24

PLCs

Operator Interfaces

Automation Software

Power Supplies

Sensors

Communication & Networking

Specifications

Part Numbers	PS5R-A05	PS5R-B05*	—	—	—	—	—	—
	PS5R-A12	PS5R-B12	PS5R-C12	—	—	—	—	—
	PS5R-A24	PS5R-B24	PS5R-C24	PS5R-D24	PS5R-Q24	PS5R-E24	PS5R-F24	PS5R-G24
Output Capacity	7.5W	15W	30W	50W	75W	100W	120W	240W
Input Voltage (single-phase, 2-wire)	100 to 240V AC nominal (85 to 264V AC), 50/60Hz (47 to 63Hz) 110 to 340V DC nominal (105 to 370V DC)					100 to 120V AC, 50/60Hz 200 to 240V AC, 50/60Hz (jumper selectable) 240 to 370V DC	100 to 240V AC, 50/60Hz, 110 to 340V DC	
Input Current (typical)	0.17A at 100V AC	0.3A at 100V AC	0.68A at 100V AC	1.15A at 100V AC	1.1A at 100V AC	2.5A at 100V AC 1.5A at 200V AC	1.8A at 100V AC	4A at 100V AC
Internal Fuse Rating	2A	2A	3.15A	3.15A	3.15A	4A	4A	6.3A
Inrush Current	50A maximum (at cold start at 200V AC)				70A maximum (at cold start at 230V AC)	50A maximum (at cold start at 200V AC)	70A maximum (at cold start at 230V AC)	
Leakage Current (at no load)	0.75mA maximum (60Hz, measured in conformance with UL, CSA, VDE)							
Typical Efficiency	69% at 5V 75% at 12V 79% at 24V		75% at 12V 75% at 24V	79% at 24V	83% at 24V	85% at 24V	83% at 24V	
Oversvoltage Protection	Outputs turns off at 105% (typical)							
Voltage and Current Ratings	5V, 1.5A 12V, 0.6A 24V, 0.3A	5V, 2.5A 12V, 1.2A 24V, 0.6A	12V, 2.5A 24V, 1.3A	24V, 2.1A	24V, 3.1A	24V, 4.2A	24V, 5A	24V, 10A
Voltage Adjustments	±10% (V.ADJ screw on top)							
Output Holding Time	20ms minimum (at full rated input and output)							
Rise Time	200ms maximum (at full rated input and output)							150ms max.
Line Regulation	0.4% maximum							
Load Regulation	1.5% maximum							
Fluctuation due to Ambient Temperature Change	0.05% maximum							
Ripple Voltage	2% peak to peak maximum (including noise)							
Overload Protection	120% typical (Zener-limiting)				120% typical, auto reset			
Operation Indicator	LED (green)							
Parallel Operation Allowed	PS5R-A	PS5R-B	PS5R-C	PS5R-D	PS5R-Q	PS5R-E	PS5R-F	PS5R-G
	No				Yes	No	Yes	
Dielectric Strength	Between input and output terminals: 3,000V AC, 1 minute Between input terminals and housing: 2,000V AC, 1 minute Between output terminal and housing: 500V AC, 1 minute							
Insulation Resistance	Between input and output terminals/input terminals and housing: 100MΩ minimum (500V DC megger)							
Operating Temperature	-10° to +60°C (14° to 140°F) (see derating curves)							
Storage Temperature	-30° to +85°C (-22° to 185°F)							
Operating Humidity	20 to 90% relative humidity (no condensation)							
Vibration Resistance	45m/s ² , 10 to 55Hz, 2 hours on each of 3 axes				10 to 50Hz, 0.75mm p-p, 2 hrs on each of 3 axes			
Shock Resistance	300m/s ² (30G), 3 shocks in each of 6 directions							
Approvals	Conforms to EMC Directives EN50081-2 & EN50082-2. LVD Directive EN60529 — Certified to EN60950. UL508 listed. UL, c-UL, TUV approved. CE marked. EN61000-3-2							
Weight	150g	170g	360g	390g	800g	600g	1200g	2000g
Termination	Spring-up, fingersafe terminals with captive M3.5 screws							
IP protection	IP20 (finger safe)							
Dimensions H x W x D (mm)	75 x 45 x 70	75 x 45 x 95	75 x 90 x 95	75 x 90 x 95	120 x 85 x 140	75 x 145 x 95	120 x 115 x 140	120 x 200 x 140
Dimensions H x W x D (inches)	2.95 x 1.77 x 2.76	2.95 x 1.77 x 3.74	2.95 x 3.54 x 3.74	2.95 x 3.54 x 3.74	4.72 x 3.35 x 5.52	2.95 x 5.71 x 3.74	4.72 x 4.53 x 5.52	4.72 x 7.87 x 5.51

1. For dimensions, see page 117.
2. For usage instructions, see page 116.
3. *12.5W for 5VDC model.

Temperature Derating Curves

PS5R-A/B

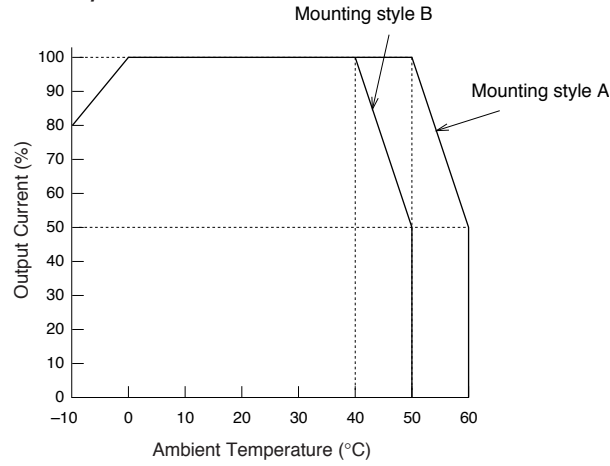

PS5R-C/D

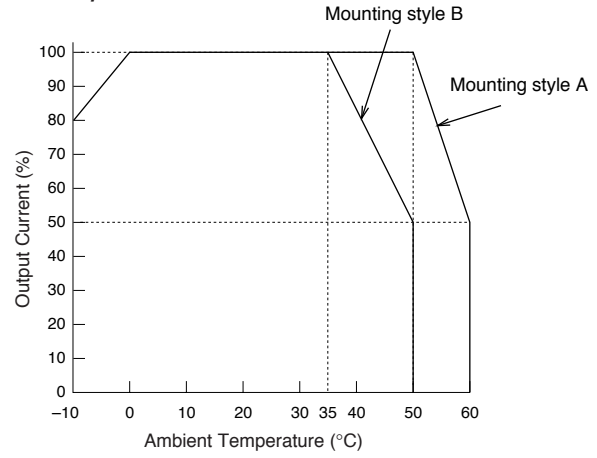

PS5R-E

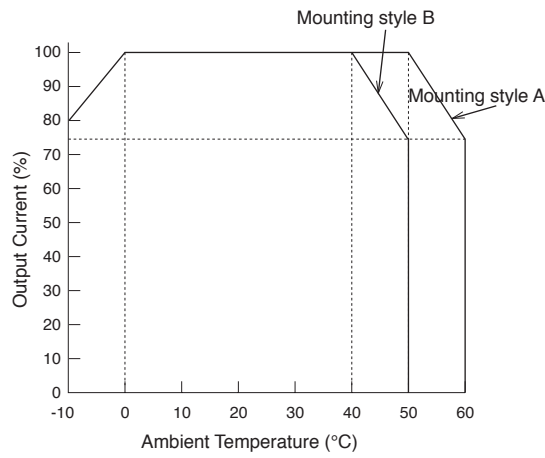

PS5R-Q

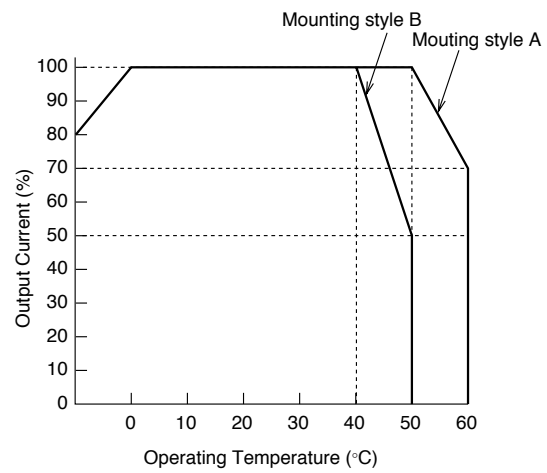

PS5R-F/G

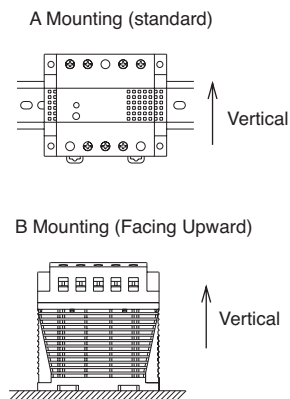
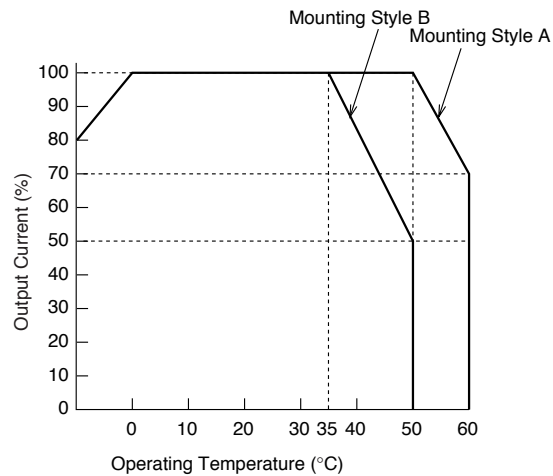

PLCs

Operator Interfaces

Automation Software

Power Supplies

Sensors

Communication & Networking

Accessories

Part Numbers: PS5R Accessories

Appearance	Description	Part Number
	DIN rail (1000mm)	BNDN1000
	DIN rail end clip	BNL5

Installation Instructions

Time-Saving Spring-up Terminals

The innovative terminals on the PS5R series use a special, spring-loaded screw. This makes installation as easy as pushing down and turning with a screwdriver. Installation time is cut in half since the screws do not need to be backed out to install wiring. The screws are held captive once installed and are 100% finger-safe. Screw terminals accept bare wire or ring or fork connectors.

1. Insert the wire connector into the slot on the side of the power supply.



2. Using a flat head or Phillips screwdriver, push down and turn the screw.

The wire is now connected, and the screw terminal is finger-safe!

Front Panel (terminals)

Markings	Name	Description
V. ADJ	Voltage adjustment	Adjusts within $\pm 10\%$; turn clockwise to increase output voltage
DC ON	Operation indicator	Green LED is lit when output voltage is on
+V, -V	DC output terminals	+V: Positive output Terminal -V: Negative output terminal
	Frame ground	Ground this terminal to reduce high-frequency currents caused by switching
L, N	Input terminals	Accept a wide range of voltages and frequencies (no polarity at DC input)
NC	No connection	Do not insert wires here, as this may damage the power supply

Overcurrent Protection Characteristics

PS5R-A/B

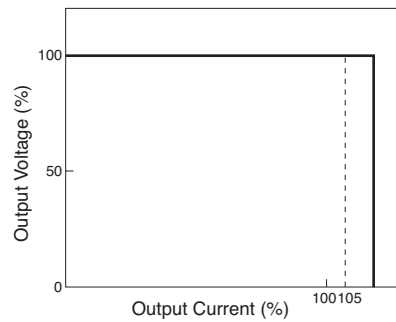

PS5R-C/D/E

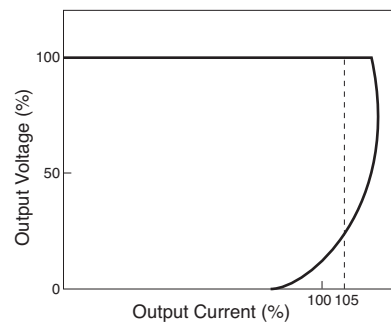

Parallel Operation

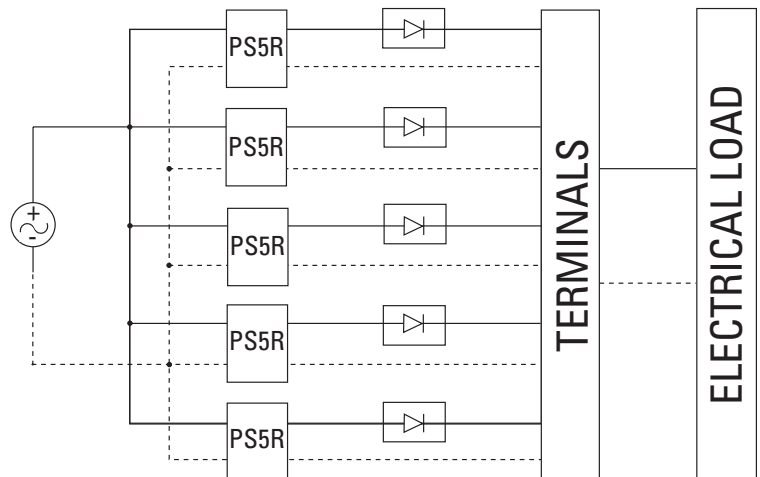

1. Parallel operation only recommended for PS5R-Q24, PS5R-F24 and PS5R-G24.
2. Factory recommended diode ST Microelectronics BYV54V-50, BYV54V-100, BYV54V-200, BYV541V-200 or with equivalent electrical specifications.
3. Using the voltage adjustment make sure out-voltage is the same for all power supplies.

PLCs

Operator Interfaces

Automation Software

Power Supplies

Sensors

Communication & Networking

Dimensions

PS5R-A (7.5W)

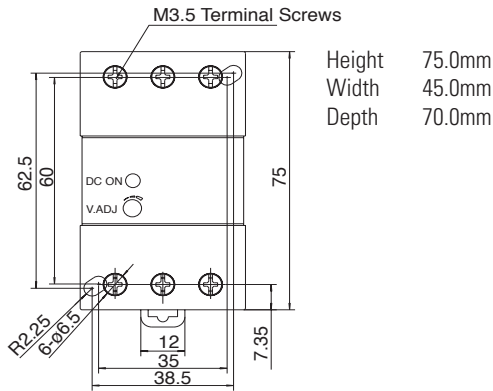

PS5R-B (15W)

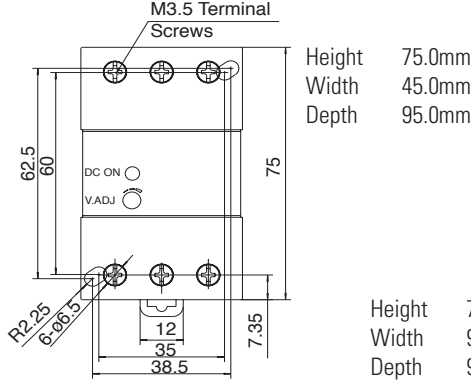

PS5R-C (30W)

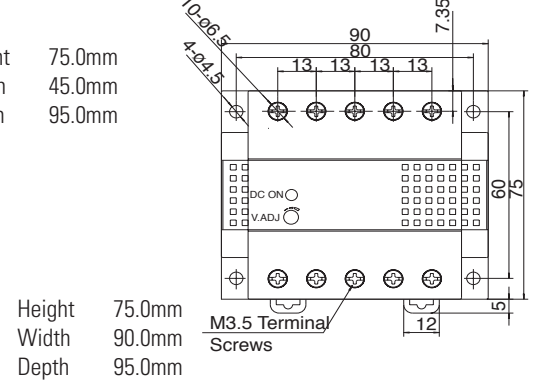

PS5R-D (50W)

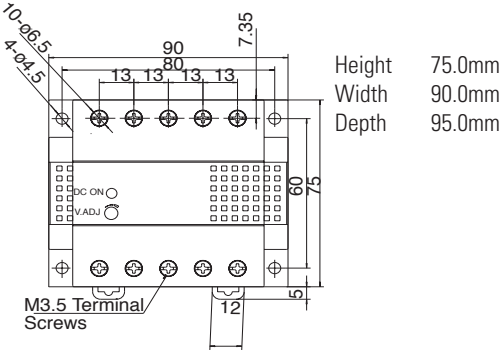

PS5R-Q (75W)

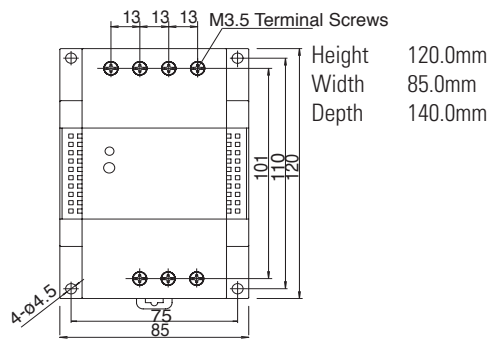

PS5R-F (120W)

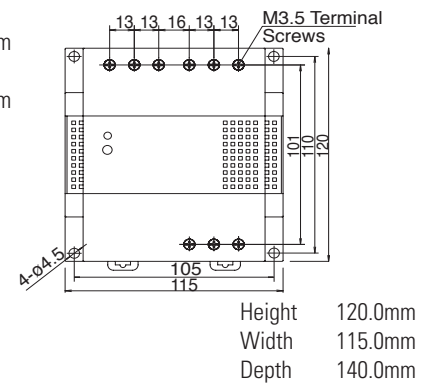

PS5R-E (100W)

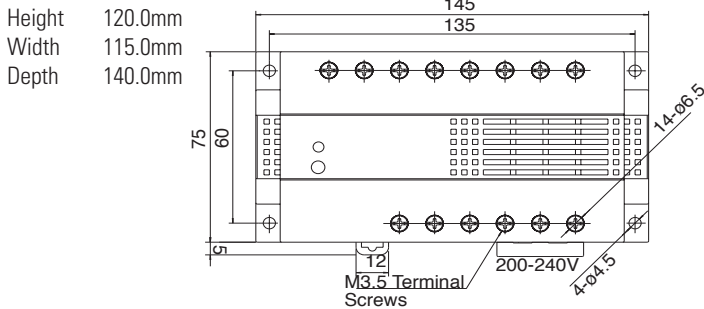

PS5R-G (240W)

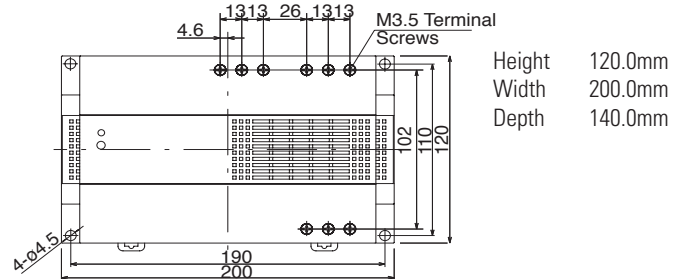

Terminal Markings

PS5R-A/B

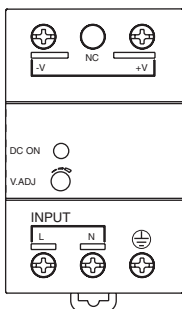

PS5R-C/D/Q/F/G

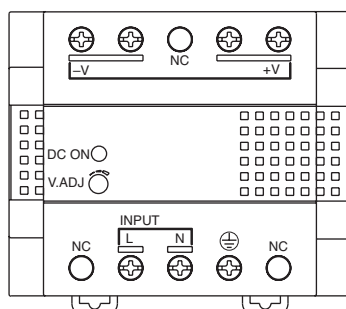

PS5R-E

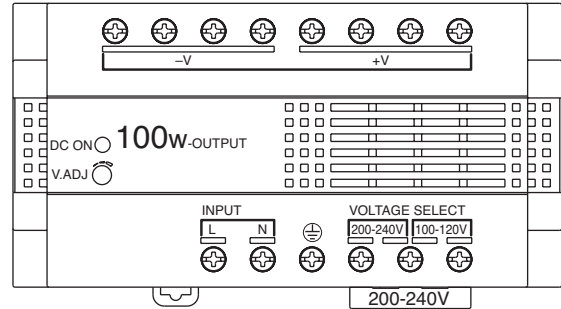

PLCs

Operator Interfaces

Automation Software

Power Supplies

Sensors

Communication & Networking

PS3L Series Metal Frame Switching Power Supplies

Key features of the PS3L series include:

- Metal frame
- Wide power range: 10W-300W
- Universal input:
10W-30W: 85-264V AC/105-370V DC
50W-300W: 85-264V AC/105-350V DC
- Screw terminals, IP20 (fingersafe)
- Power Factor Protection
EN61000-3-2
EN61000-3-3 (50W to 300W models)
- Overcurrent/overvoltage protection
- Voltage +10% adjustment
- DIN rail or panel surface mount
- Approvals:
CE marked
UL508 listed
EN50178 compliant
EMC Directives
EN50081-2
EN61000-6-2
LVD EN60950:2000



Item	Watts	Rated Voltage	Rated Current	Part Number
	10	5V DC	2A	PS3L-A05AFF
		12V DC	0.9A	PS3L-A12AFF
		24V DC	0.5A	PS3L-A24AFF
	15	5V DC	3A	PS3L-B05AFF
		12V DC	1.4A	PS3L-B12AFF
		24V DC	0.7A	PS3L-B24AFF
	30	5V DC	6A	PS3L-C05AFF
		12V DC	2.5A	PS3L-C12AFF
		24V DC	1.3A	PS3L-C24AFF
	50	12V DC	4.3A	PS3L-D12AFF
		24V DC	2.2A	PS3L-D24AFF

Item	Watts	Rated Voltage	Rated Current	Part Number
	100	12V DC	8.5A	PS3L-E12AFF
		24V DC	4.5A	PS3L-E24AFF
	150	12V DC	13A	PS3L-F12AFF
		24V DC	6.5A	PS3L-F24AFF
	300	24V DC	12.5A	PS3L-G24AFF

PLCs

Operator Interfaces

Automation Software

Power Supplies

Sensors

Communication & Networking

Specifications

Type		PS3L-A (10W)	PS3L-B (15W)	PS3L-C (30W)	PS3L-D (50W)	PS3L-E (100W)	PS3L-F (150W)	PS3L-G24 (300W)	
Input	Input Voltage (Single-phase two-wire)	100 to 240V AC (Voltage range: 85 to 264V AC/105 to 370V DC)			100 to 240V AC (Voltage range: 85 to 264V AC/105 to 350V DC)				
	Frequency (AC input only)	47 to 63Hz							
	Input Current (Typical)	100V	0.25A	0.37A	0.68A	0.68A	1.4A	2.0A	3.8A
		200V	0.16A	0.23A	0.45A	0.34A	0.65A	0.95A	2.0A
	Inrush Current (Cold start)	100V	20A max.	20A max.	20A max.	30A max.	30A max.	30A max.	30A max.
		200V	40A max.	40A max.	40A max.	60A max.	60A max.	60A max.	60A max.
	Leakage Current	0.75 mA max. (60Hz; UL, CSA, VDE)							
Power Factor (Typical)	—				0.99 (100V AC input, rated output), 0.95 (200V AC, rated output)				
Efficiency (Typical)	5V DC:	70%	73%	75%	—	—	—	—	
	12V DC:	74%	75%	77%	76%	78%	80%	—	
	24V DC:	78%	78%	79%	79%	81%	83%	81%	
Output	Rated Voltage/Current	5V/2A	5V/3A	5V/6A	—	—	—	—	
		12V/0.9A	12V/1.4A	12V/2.5A	12V/4.3A	12V/8.5A	12V/13A	—	
		24V/0.5A	24V/0.7A	24V/1.3A	24V/2.2A	24V/4.5A	24V/6.5A	24V/12.5A	
	Adjustable Voltage Range	±10% (V.ADJ control on front)							
	Output Holding Time	20msec minimum (at the rated input and output)							
	Start Time	200msec maximum (at the rated input and output)			500msec maximum (at the rated input and output)				
	Rise Time	100msec maximum (at the rated input and output)			200msec maximum (at the rated input and output)				
	Regulation	Input Fluctuation	5V: 20mV maximum, 12V: 48mV maximum, 24V: 96mV maximum						
		Load Fluctuation	5V: 40mV maximum, 12V: 100mV maximum, 24V: 150mV maximum						
		Temperature Change (-10 to +50°C)	5V: 50mV maximum 12V: 120mV maximum 24V: 240mV maximum			5V: 60mV maximum 12V: 150mV maximum 24V: 290mV maximum			
Ripple Voltage			-10 to 0°C: 5V: 160mV maximum, 12V/24V: 180mV maximum ¹					200 mV maximum ¹	
Supplementary Functions	Overcurrent Protection	105% (Typical), Automatic reset ²							
	Overvoltage Protection	120% min. ³	Output off at 120%, reset when input voltage is restored. ⁴						
	Operation Indicator	LED (green)							
Dielectric Strength		Between input and output terminals: 3,000V AC, 1 minute Between input terminal and housing: 2,000V AC, 1 minute Between output terminal and housing: 500V AC, 1 minute							
Insulation Resistance		Between input and output terminals: 100MW minimum (500V DC megger) Between input terminal and housing: 100MW minimum (500V DC megger)							
Operating Temperature ⁵		-10° to +70°C			-10° to +60°C		-10° to +65°C		
Storage Temperature		-30° to +75°C							
Operating Humidity		20 to 90% RH (no condensation, no freezing)							
Vibration Resistance		10 to 55Hz, 20m/s ² constant, sweep cycle 1 minute, 2 hours each in 3 axes							
Shock Resistance		200m/s ² , 11ms, 1 shock each in 3 axes							
Dimensions H X W X D (mm)		97 x 35 x 86	97 x 35 x 86	96 x 35 x 114.5	97 x 37 x 147.5	97 x 54 x 200	97 x 62 x 200	158 x 63 x 230	
Weight (Approx.)		240g	250g	340g	350g	630g	730g	1550g	
Terminal Screw		M4 slotted-Phillips head screw (screw terminal type)							



- Including noise. Measured at the terminal block according to EIAJ.
- Protection against short-circuit and overcurrent of 30 seconds maximum. Overload for 30 seconds or longer may damage the internal elements.
- Zener limiter method
- Turn the input off and after one minute, turn the input on again.
- Refer to the derating characteristics. No freezing. The maximum temperature is the temperature at 100% output current (natural air-cooling) in the derating characteristics.

PLCs

Operator Interfaces

Automation Software

Power Supplies

Sensors

Communication & Networking

Characteristics

Operating Temperature vs. Output Current Characteristics (Derating Curves)

PS3L-A/B/C/D

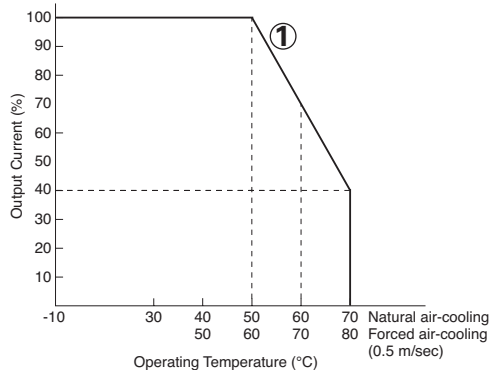

Conditions: At rated input/output (operating temperature is the temperature around the power supply)

① Mounting Directions A and B

PS3L-E/F

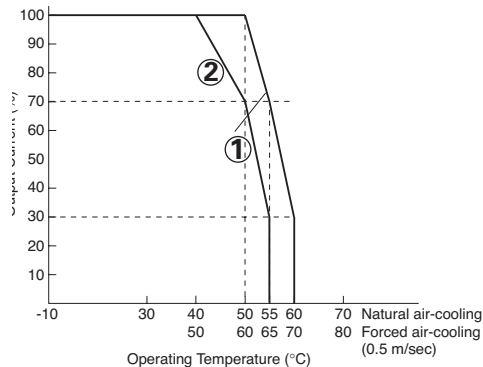

Conditions: At rated input/output (operating temperature is the temperature around the power supply)

① Mounting Direction A
② Mounting Direction B

PS3L-G

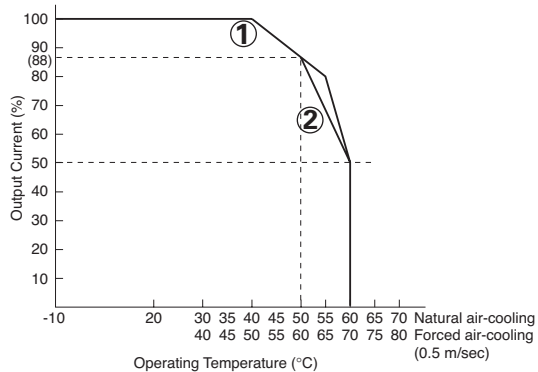

Conditions: At rated input/output (operating temperature is the temperature around the power supply)

① Mounting Direction A
② Mounting Direction B

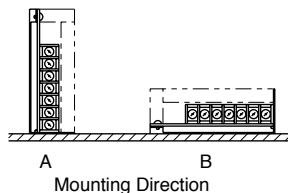

Overcurrent Protection Characteristics

PS3L-A/B

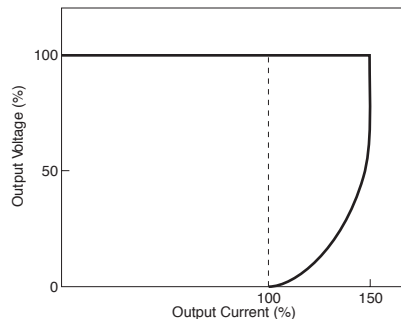

PS3L-C/D/E/F/G

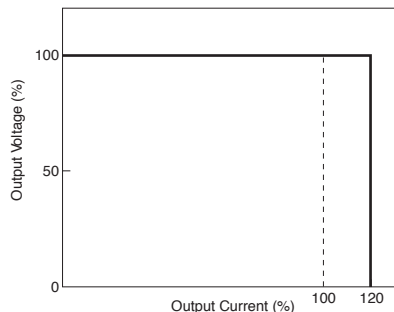

PLCs

Operator Interfaces

Automation Software

Power Supplies

Sensors

Communication & Networking

Terminal Markings

PS3L-A/B

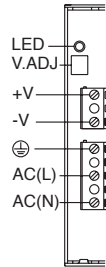

PS3L-C/D

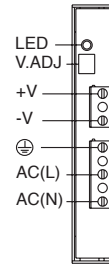

PS3L-E/F

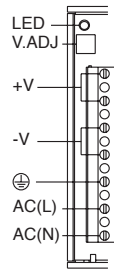

PS3L-G

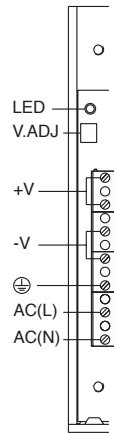

Marking	Name	Description
V.ADJ	Output Voltage Adjustment	Allows adjustment within $\pm 10\%$. Turning clockwise increases the output voltage.
LED	Operation Indicator (Green)	Lights when the output voltage is on.
+V -V	DC Output Terminals	+V: Positive output terminal -V: Negative output terminal
	Ground Terminal	Grounding the terminal reduces high-frequency currents caused by switching.
AC	Input Terminal	Accepts a wide range of voltage and frequency. Polarity is irrelevant when using a DC input.

Accessories

Mounting Bracket (Optional)

Model	Mounting Plate	L-shaped Bracket (wide)	L-shaped Bracket (narrow)	Dimensions
PS3L-A/B	PS9Z-3E1B	PS9Z-3E2B	PS9Z-3E3B	See page 124
PS3L-C	PS9Z-3E1C	PS9Z-3E2C	PS9Z-3E3C	
PS3L-D	PS9Z-3E1D	PS9Z-3E2D	PS9Z-3E3D	
PS3L-E	PS9Z-3L1F	PS9Z-3E2E	PS9Z-3E3E	
PS3L-F	PS9Z-3L1F	PS9Z-3E2F	PS9Z-3E3F	
PS3L-G	PS9Z-3L1G	—	—	

DIN-Rail Mounting Bracket (Optional)

Model	Part Number
PS3L-A	PS9Z-3E4C
PS3L-B	
PS3L-C	PS9Z-3E4D
PS3L-D	
PS3L-E	PS9Z-3E4F
PS3L-F	

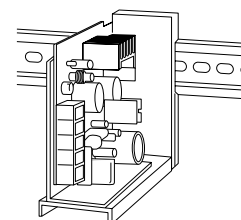

DIN-rail mounting brackets are ordered separately from switching power supplies.

DIN-Rail Mounting Bracket Dimensions

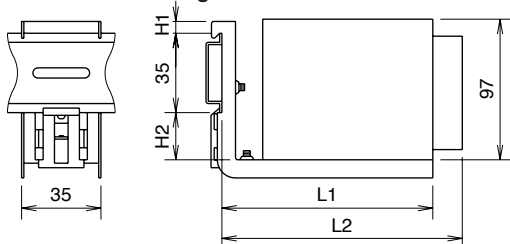

Part Number	Model	L1 (mm)	L2 (mm)	L3 (mm)	H1 (mm)	H2 (mm)
PS9Z-3E4C	PS3L-A	134	117	35	5.2	20.8
	PS3L-B					
	PS3L-C					
PS9Z-3E4D	PS3L-D	186	178.8	39.5	5.2	20.8
PS9Z-3E4F	PS3L-E	216.8	230.8	65	11.2	20
	PS3L-F					

DIN Rail (Optional)

Part Number	Length	Material
BNDN1000	1000 mm	Aluminum

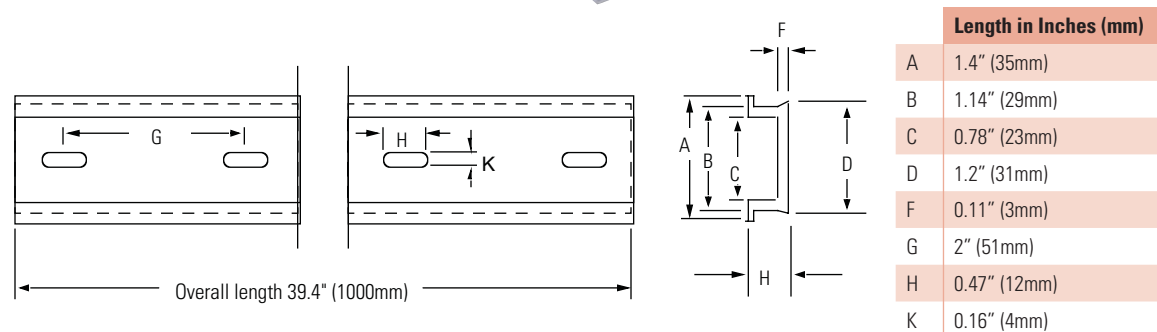

End Clip (Optional)

Item	Package No.
DIN Rail End Clip	BNL5



PLCs

Operator Interfaces

Automation Software

Power Supplies

Sensors

Communication & Networking

Dimensions
(tolerance $\pm 1\text{mm}$)

PS3L-A/B (10/15W)

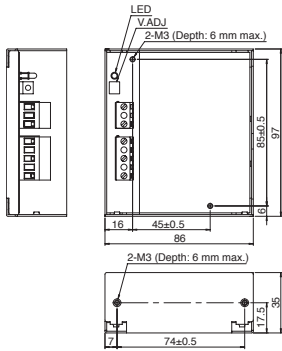

Height 97.0mm
Width 35.0mm
Depth 86.0mm

PS3L-C (30W)

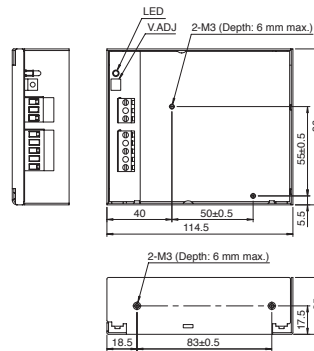

Height 96.0mm
Width 35.0mm
Depth 114.5mm

PS3L-D (50W)

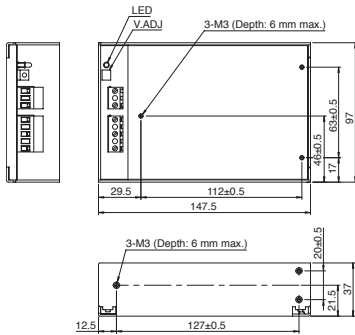

Height 97.0mm
Width 37.0mm
Depth 147.5mm

PS3L-E (100W)

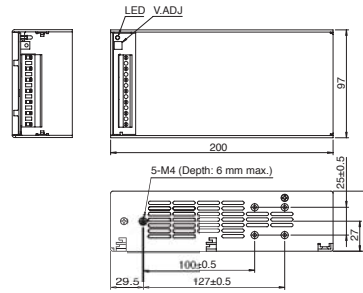

Height 97.0mm
Width 54.0mm
Depth 200.0mm

PS3L-F (150W)

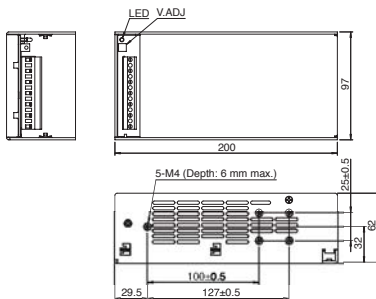

Height 97.0mm
Width 62.0mm
Depth 200.0mm

PS3L-G (300W)

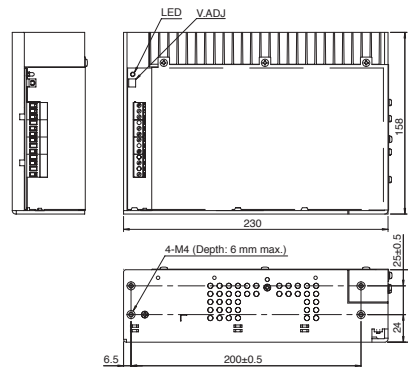

Height 158.0mm
Width 63.0mm
Depth 230.0mm

PLCs

Operator Interfaces

Automation Software

Power Supplies

Sensors

Communication & Networking

Mounting Bracket Dimensions (PS9Z-3E1/PS9Z-3E2/PS9Z-3E3/PS9Z-3L)

Mounting Plate

PS9Z-3E1B/3E1C

(For 10W/15W/30W Types)

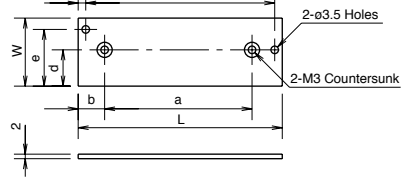

Part Number	Dimensions (mm)							
	W	L	l	a	b	c	d	e
PS9Z-3E1B	35	101	94	74	14.5	3.5	17.5	30
PS9Z-3E1C	33	138.5	128.5	83	32	5	17.5	26

PS9Z-3E1D

(For 50W Type)

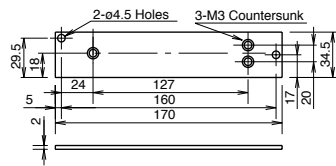

PS9Z-3L1F

(For 100W/150W Types)

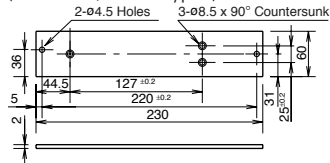

PS9Z-3L1G

(For 300W Type)

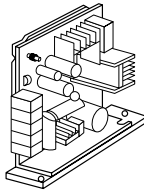
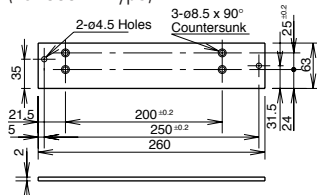

Mounting Hole Layout

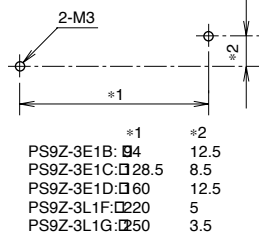

L-shaped Bracket (wide)

PS9Z-3E2B/3E2C

(For 10W/15W/30W Types)

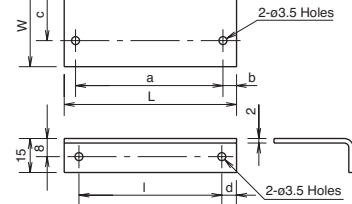

Part Number	Dimensions (mm)						
	W	L	l	a	b	c	d
PS9Z-3E2B	36	95.5	80.5	74	9.5	18.5	7.5
PS9Z-3E2C	38	118.5	104	83	15	20.5	7.5

PS9Z-3E2D

(For 50W Type)

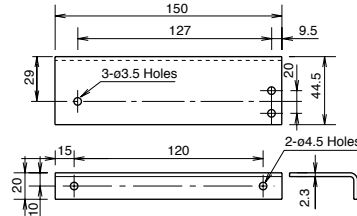

PS9Z-3E2E/3E2F

(For 100W/150W Types)

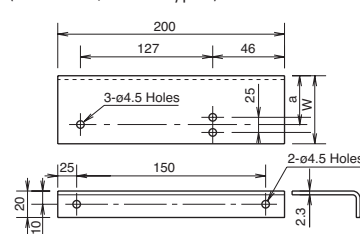

Part Number	Dimensions (mm)	
	W	a
PS9Z-3E2E	59	34.5
PS9Z-3E2F	70	40

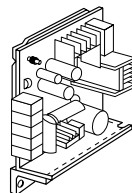

Mounting Hole Layout

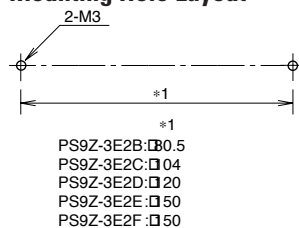

L-shaped Bracket (narrow)

PS9Z-3E3B/3E3C

(For 10W/15W/30W Types)

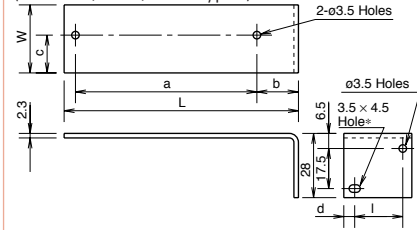

Part Number	Dimensions (mm)						
	W	L	l	a	b	c	d
PS9Z-3E3B	31	103	22.5	74	18	13.5	4.5
PS9Z-3E3C	33	126	25	83	21	15.5	4

PS9Z-3E3D

(For 50W Type)

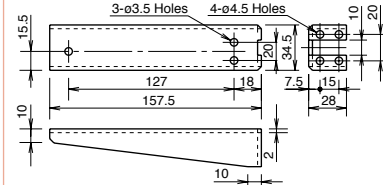

PS9Z-3E3E/3E3F

(For 100W/150W Types)

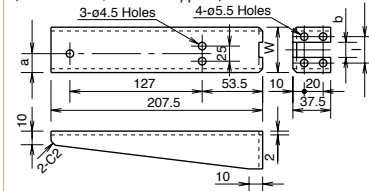

Part Number	Dimensions (mm)			
	W	l	a	b
PS9Z-3E3E	54	32.5	27	12.5
PS9Z-3E3F	65	40	32.5	20

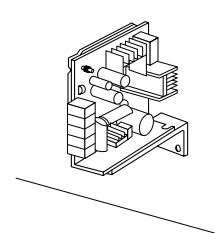

Mounting Hole Layout

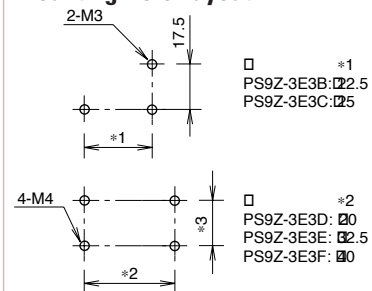

Direct Mount Installation

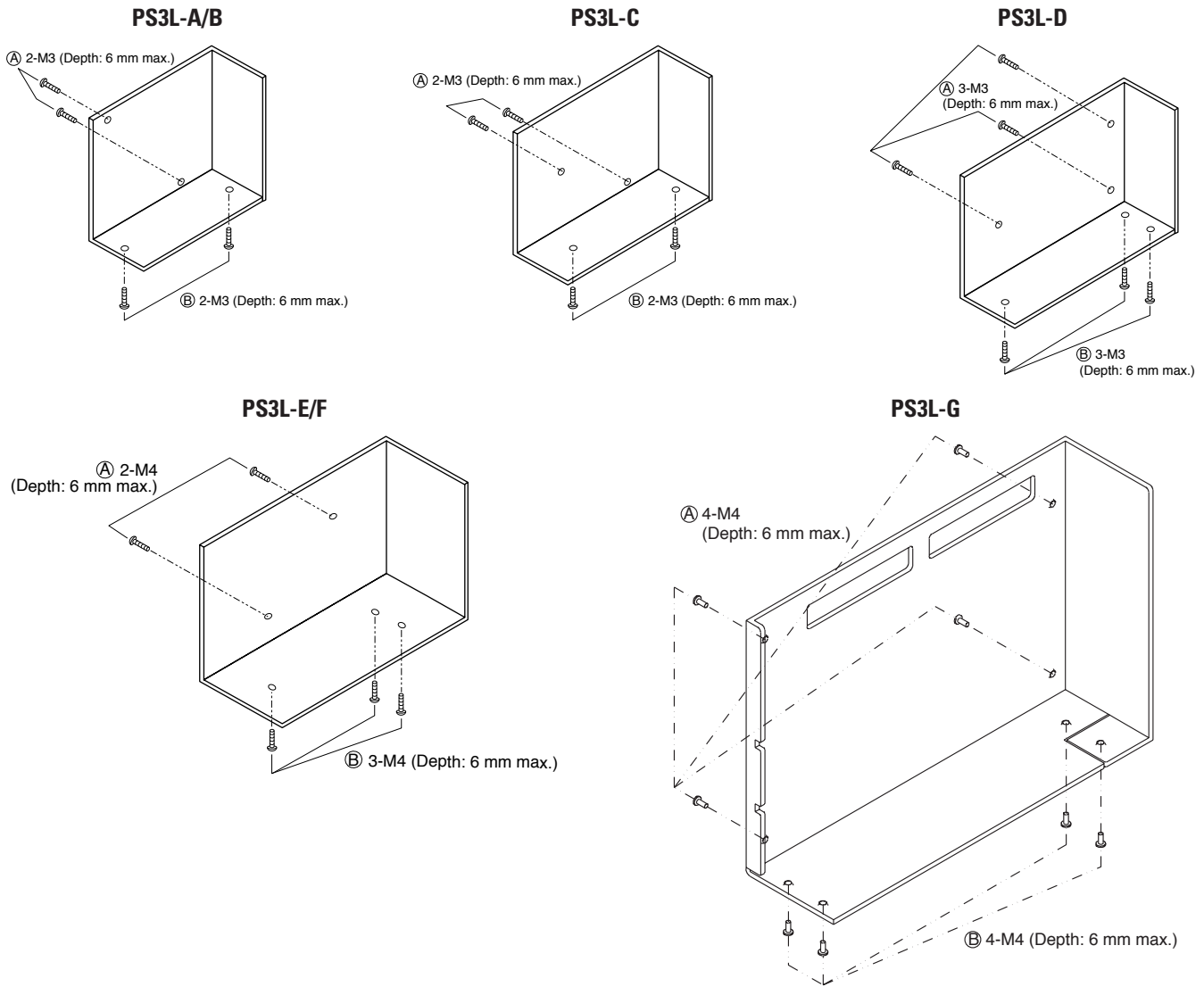

The figures above show the frames only. PC board and parts are omitted for illustration purposes. Mounting screws NOT supplied with power supplies.

Installation	Mounting Hole Layout				
	PS3L-A/B	PS3L-C	PS3L-D	PS3L-E/F	PS3L-G
A Side Mounting (screw from the back)					
B Side Mounting (screw from the back)					

Instructions

Notes for Installation

- PS3L switching power supplies can be installed in either (A) or (B) directions as shown below. For PS3L-E/F/G types, the operating temperature vs. output current characteristics vary with the mounting direction. See the derating curves 120.

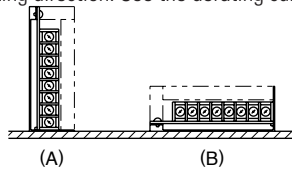

- Mount the switching power supply on a metallic surface that provides adequate heat dissipation. Be sure to prevent heat build-up around power supplies.

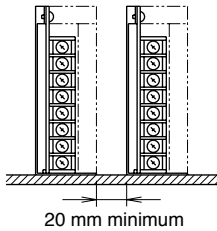

- Maintain 20 mm clearance between the power supplies.
- Use mounting screws of a proper length so that screws do not penetrate into the housing of the switching power supply 6 mm or more.
- Mounting screws cannot be fastened on a PC board. Be sure to fasten the screws on the chassis side.

Adjustment of Output Voltage

The output voltage can be adjusted within $\pm 10\%$ of the rated output voltage by using the V.ADJ control on the front. Turning the V.ADJ clockwise increases the output voltage. When using a higher output voltage, reduce the output current to make sure that the output capacity is within the rating. Note that overvoltage protection may work when increasing the output voltage.

Overcurrent Protection

The output voltage drops automatically when an overcurrent flows due to an overload or short circuit. Normal voltage is automatically restored when the load returns to normal conditions.

Overvoltage Protection (PS3L-A)

The PS3L-A uses a Zener diode for overvoltage protection. Do not apply an external overvoltage to the output terminal.

(PS3L-B/C/D/E/F/G)

The output is turned off by overvoltage protection when an overvoltage is applied. When the output voltage has dropped due to an overvoltage (120% or more), turn the input off, and after one minute, turn the input on again.

Series Operation

The following series operations are allowed.

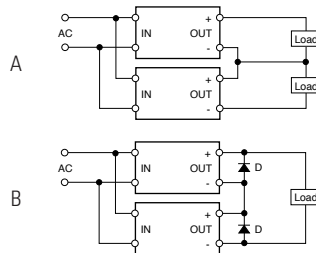

For series operation (B), insert Schottky diodes D as shown in the figure. Select a Schottky diode in consideration of the rated current.

Notes for Operation

- Output interruption may indicate blown fuses.
- The internal fuse inside the power supply is for AC input. When using with DC input, install an external fuse for DC input. To avoid blown fuses, select fuses in consideration of the rated current of internal fuses.

Rated Current of Internal Fuses

Part Number	Rated Fuse Current
PS3L-A	2A
PS3L-B	
PS3L-C	3.15A
PS3L-D	2A
PS3L-E	4A
PS3L-F	
PS3L-G	6.3A

- Avoid overload and short-circuit for a long period of time, otherwise the internal elements may be damaged.

4. Not suitable for parallel operation.

- DC input operation is not subject to safety standards.

Insulation/Dielectric Test

When conducting an insulation/dielectric test, short-circuit the input (between AC) and output (between + and -). Do not apply or interrupt the voltage suddenly, otherwise the surge voltage may be generated and the power supply may be damaged.

Safety Precautions

- Do not use switching power supplies with electric equipment whose malfunction or inadvertent operation may damage the human body or life directly.
- Make sure that the input voltage and output current do not exceed the ratings. If the input voltage and output current exceed the ratings, electric shock, fire, or malfunction may occur.
- Do not disassemble, repair, or modify the power supplies.
- Do not touch the switching power supplies while input voltage is applied, otherwise electric shock may occur.
- Provide the final product with protection against malfunction or damage that may be caused by the malfunction of switching power supplies.
- Operating temperatures should not exceed the ratings. Be sure to note the derating characteristics. If the operating temperature exceeds the ratings, electric shock, fire, or malfunction may occur.
- Blown fuses indicate that the internal circuits are damaged. Do not just replace the fuse and reoperate, otherwise electric shock, fire, or malfunction may occur.
- Do not use the switching power supplies to charge rechargeable batteries.**