

**FLAT/VERTICAL TYPE
HIGH POWER BIFURCATED
CONTACT**

HN RELAYS (AHN)

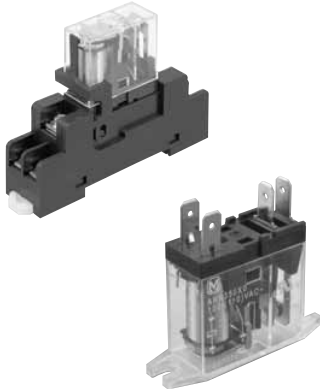

RoHS Directive compatibility information
<http://www.mew.co.jp/ac/e/environment/>

FEATURES

- 1. Slim and compact size**
20% smaller (width and height) than existing model* (with the condition of screw terminal socket for DIN rail)
*Compared with our HC/HJ relay.
- 2. High-capacity and high reliability**
Max. switching current:
16 A (for 1 Form C type at AC load)
Uses gold-flashed contacts for highly reliable contact (for 2 Form C type).
- 3. Environmentally friendly**
Cadmium-free contacts and lead-free solder are used.
- 4. Slim screw terminal socket and PC board terminal socket**
Utilizes relay-securing hook for easy relay removal.
One-touch relay removal possible.
Terminal sockets with finger protect function available.

- 5. Full lineup**
We added a TM type that can be built into devices.

TYPICAL APPLICATIONS

- Control panels**
- Power supply units**
- Molding machines**
- Machine tools**
- Welding equipment**
- Agricultural equipment**
- Office equipment**
- Vending machines**
- Communications equipment**
- Amusement machines, etc.**

ORDERING INFORMATION

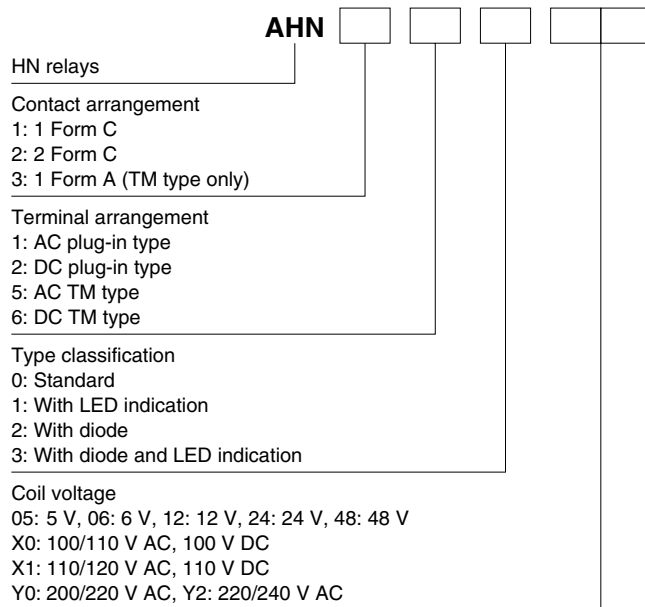

Note: Products conform to UL/C-UL and VDE, as standard.
(VDE under application for TM type.)

HN (AHN)

TYPES

1. Plug-in type

Coil voltage	1 Form C	2 Form C
	Part No.	Part No.
5V DC	AHN12005	AHN22005
6V DC	AHN12006	AHN22006
12V DC	AHN12012	AHN22012
24V DC	AHN12024	AHN22024
48V DC	AHN12048	AHN22048
100V DC	AHN120X0	AHN220X0
110V DC	AHN120X1	AHN220X1
12V AC	AHN11012	AHN21012
24V AC	AHN11024	AHN21024
100/110V AC	AHN110X0	AHN210X0
110/120V AC	AHN110X1	AHN210X1
200/220V AC	AHN110Y0	AHN210Y0
220/240V AC	AHN110Y2	AHN210Y2

Note: Packing quantity; Carton: 50 pcs, Case: 500 pcs.

2. Plug-in type (with LED indication)

Coil voltage	1 Form C	2 Form C
	Part No.	Part No.
5V DC	AHN12105	AHN22105
6V DC	AHN12106	AHN22106
12V DC	AHN12112	AHN22112
24V DC	AHN12124	AHN22124
48V DC	AHN12148	AHN22148
100V DC	AHN121X0	AHN221X0
110V DC	AHN121X1	AHN221X1
12V AC	AHN11112	AHN21112
24V AC	AHN11124	AHN21124
100/110V AC	AHN111X0	AHN211X0
110/120V AC	AHN111X1	AHN211X1
200/220V AC	AHN111Y0	AHN211Y0
220/240V AC	AHN111Y2	AHN211Y2

Note: Packing quantity; Carton: 50 pcs, Case: 500 pcs.

3. Plug-in type (with diode)

Coil voltage	1 Form C	2 Form C
	Part No.	Part No.
5V DC	AHN12205	AHN22205
6V DC	AHN12206	AHN22206
12V DC	AHN12212	AHN22212
24V DC	AHN12224	AHN22224
48V DC	AHN12248	AHN22248
100V DC	AHN122X0	AHN222X0
110V DC	AHN122X1	AHN222X1

Note: Packing quantity; Carton: 50 pcs, Case: 500 pcs.

4. Plug-in type (with diode and LED indication)

Coil voltage	1 Form C	2 Form C
	Part No.	Part No.
5V DC	AHN12305	AHN22305
6V DC	AHN12306	AHN22306
12V DC	AHN12312	AHN22312
24V DC	AHN12324	AHN22324
48V DC	AHN12348	AHN22348
100V DC	AHN123X0	AHN223X0
110V DC	AHN123X1	AHN223X1

Note: Packing quantity; Carton: 50 pcs, Case: 500 pcs.

5. TM type

Coil voltage	1 Form A
	Part No.
5V DC	AHN36005
6V DC	AHN36006
12V DC	AHN36012
24V DC	AHN36024
48V DC	AHN36048
100V DC	AHN360X0
110V DC	AHN360X1
12V AC	AHN35012
24V AC	AHN35024
100/110V AC	AHN350X0
110/120V AC	AHN350X1
200/220V AC	AHN350Y0
220/240V AC	AHN350Y2

Note: Packing quantity; Carton: 50 pcs, Case: 500 pcs.

6. Accessories

Type	No. of poles	Item	Part No.
Screw terminal socket	1-pole	HN1 screw terminal socket	AHNA11
		HN1 screw terminal socket (Finger protect type)	AHNA11P
	2-pole	HN2 screw terminal socket	AHNA21
		HN2 screw terminal socket (Finger protect type)	AHNA21P
PC board terminal socket	1-pole	HN1 PC board terminal socket	AHNA13
	2-pole	HN2 PC board terminal socket	AHNA23

Notes: 1. Packing quantity: 10pcs. (Carton), 100pcs. (Case)
2. Products conform to UL/C-UL, as standard.

• Specifications

Item		Performance					
Type		HN1 screw terminal socket	HN1 screw terminal socket (Finger protect type)	HN1 PC board terminal socket	HN2 screw terminal socket	HN2 screw terminal socket (Finger protect type)	HN2 PC board terminal socket
Contact arrangement		1 Form C			2 Form C		
Max. continuous current (Ambient temperature: -40 to +70°C -40 to +158°F)		16A*	10A	10A	5A	5A	5A
Initial breakdown voltage	Between open contacts	1,000 Vrms for 1 min. (Detection current: 10mA)					
	Between contact sets	—		3,000 Vrms for 1 min. (Detection current: 10mA)			
	Between contact and coil	5,000 Vrms for 1 min. (Detection current: 10mA)					
Initial insulation resistance		1,000 MΩ between each terminal (500V DC)					

* When using with current of 16 A (for HN1 screw terminal socket), the maximum ambient temperature is 50°C.

When using between 50°C and 70°C, please reduce by 0.1 A/°C.

Notes: 1. In order to prevent breakage and disfiguring, the screw tightening torque for the terminal socket should be within the range of 0.5 to 0.8 N-m.

2. When attaching the terminal socket directly to a chassis, please use the metric coarse thread screw.

- AHNA11 and AHNA21: M3 × 16, - AHNA11P and AHNA21P: M3 × 30

RATING

1. Coil data

1) DC coils

Coil voltage	Pick-up voltage (at 20°C 68°F)	Drop-out voltage (at 20°C 68°F)	Nominal coil current [±20%]	Coil resistance (at 20°C 68°F)	Nominal operating power	Max. allowable voltage (at 20°C 68°F)
5V DC	70%V or less of nominal voltage (Initial)	15%V or more of nominal voltage (Initial)	106.4mA	47Ω [±10%]	0.53W	170%V of nominal voltage
6V DC			88.2mA	68Ω [±10%]		
12V DC			44.4mA	270Ω [±10%]		
24V DC			22.0mA	1,090Ω [±10%]		
48V DC			11.0mA	4,350Ω [±10%]		
100V DC			5.3mA	18,870Ω [±10%]		
110V DC			4.8mA	22,830Ω [±10%]		

2) AC coils (50/60Hz)

Coil voltage	Pick-up voltage (at 20°C 68°F)	Drop-out voltage (at 20°C 68°F)	Nominal coil current [±20%]		Nominal operating power		Max. Allowable voltage (at 20°C 68°F)
			50Hz	60Hz	50Hz	60Hz	
12V AC	80%V or less of nominal voltage (Initial)	30%V or more of nominal voltage (Initial)	93mA	75mA	Approx. 1.1 to 1.4 V A	Approx. 0.9 to 1.2 V A	140%V of nominal voltage
24V AC			46.5mA	37.5mA			
100/110V AC			11.0/13.0mA	9.0/10.6mA			
110/120V AC			10.0/11.8mA	8.2/9.7mA			
200/220V AC			5.5/6.5mA	4.5/5.3mA			
220/240V AC			5.0/5.9mA	4.1/4.8mA			

HN (AHN)

2. Specifications (Plug-in Standard type and TM type)

Characteristics	Item	Specifications			
		1 Form C	2 Form C	1 Form A (TM type)	
Contact	Arrangement	1 Form C	2 Form C	1 Form A (TM type)	
	Initial contact resistance, max	Max. 100 mΩ (By voltage drop 6 V DC 1A)	Max. 50 mΩ (By voltage drop 6 V DC 1A)	Max. 100 mΩ (By voltage drop 6 V DC 1A)	
	Contact material	AgSnO ₂ type	Au-flashed AgNi type	AgSnO ₂ type	
Rating	Nominal switching capacity (resistive load)	10A 250V AC, 10A 30V DC	5A 250V AC, 5A 30V DC	16A 250V AC, 16A 30V DC	
	Max. switching power (resistive load)	4,000VA, 300W	1,250VA, 150W	4,000VA, 480W	
	Max. switching voltage	250V AC, 30V DC			
	Max. switching current	16A (at AC load), 10A (at DC load)	5A	16A	
	Nominal operating power	0.53W, 0.9VA			
	Min. switching capacity (Reference value)*1	100mA 5V DC	1mA 1V DC	100mA 5V DC	
Electrical characteristics	Insulation resistance (Initial)	Min. 1,000MΩ (at 500V DC) Measurement at same location as "Initial breakdown voltage" section.			
	Breakdown voltage (Initial)	Between open contacts	1,000 Vrms for 1min. (Detection current: 10mA.)		
		Between contact sets	—	3,000 Vrms for 1min. (Detection current: 10mA.)	—
		Between contact and coil	5,000 Vrms for 1min. (Detection current: 10mA.)		
	Temperature rise (at 70°C 158°F)	Max. 60°C (By resistive method, nominal voltage)			
	Operate time (at 20°C 68°F)*2	Max. 15ms (Nominal voltage applied to the coil, excluding contact bounce time.)			
	Release time (at 20°C 68°F)*2	Max. 5ms (Nominal voltage applied to the coil, excluding contact bounce time.) (without diode)/ Max. 20ms (with diode)			
Mechanical characteristics	Shock resistance	Functional	Min. 100 m/s ² (Half-wave pulse of sine wave: 11 ms; detection time: 10μs.)		
		Destructive	Min. 1,000 m/s ² (Half-wave pulse of sine wave: 6 ms.)		
	Vibration resistance	Functional	10 to 55 Hz at double amplitude of 1.5 mm (Detection time: 10μs.)		
		Destructive	10 to 55 Hz at double amplitude of 1.5 mm		
Expected life	Mechanical	AC: Min. 10 ⁷ ; DC: Min. 2×10 ⁷ (at 300 cpm)			
	Electrical (resistive load)	Min. 10 ⁵ (at 20 cpm)	Min. 10 ⁵ (at 10 cpm)		
Conditions	Conditions for operation, transport and storage*3 (Not freezing and condensing at low temperature)	Ambient temperature: -40°C to +70°C -40°F to +158°F Humidity: 5 to 85% R.H. (Not freezing and condensing at low temperature)			
	Max. Operating speed	20 cpm (at rated load)		10 cpm (at rated load)	
	Unit weight	Approx. 19 g .67 oz	Approx. 17 g .60 oz	Approx. 19 g .67 oz	

Notes: *1 This value can change due to the switching frequency, environmental conditions and desired reliability level, therefore it is recommended to check this with the actual load.

*2 For the AC coil types, the operate/release time will differ depending on the phase.

*3 Refer to 6. Conditions for operation, transport and storage mentioned in AMBIENT ENVIRONMENT.

REFERENCE DATA

1-(1). Max. switching capacity (1 Form C and 1 Form A)

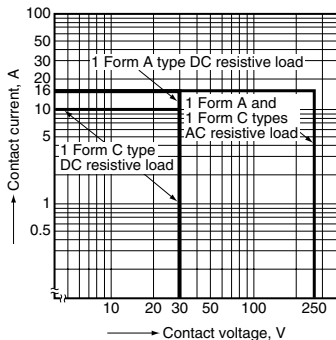

1-(2). Max. switching capacity (2 Form C)

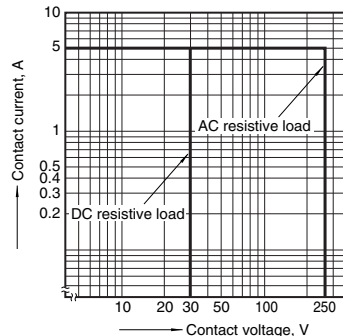

2-(1). Coil temperature rise (1 Form C/AC and 1 Form A/AC types)

Measured portion: Inside the coil
Ambient temperature: 70°C 158°F

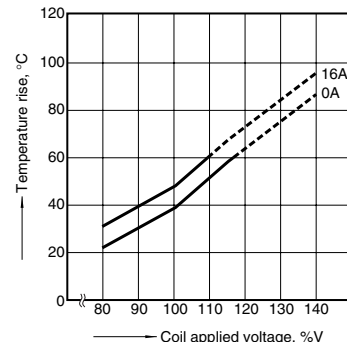

2-(2). Coil temperature rise (1 Form C/DC and 1 Form A/DC types)
 Measured portion: Inside the coil
 Ambient temperature: 70°C 158°F

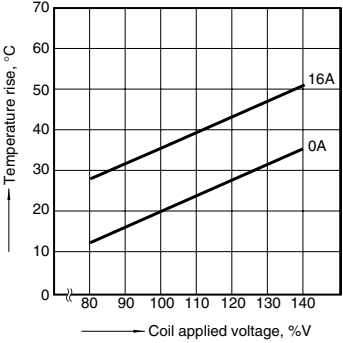

2-(3). Coil temperature rise (2 Form C/AC type)
 Measured portion: Inside the coil
 Ambient temperature: 70°C 158°F

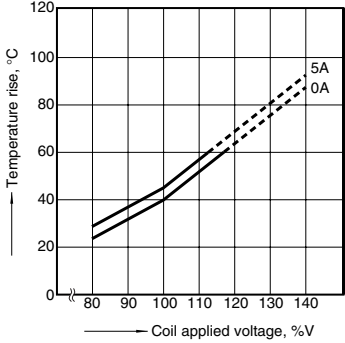

2-(4). Coil temperature rise (2 Form C/DC type)
 Measured portion: Inside the coil
 Ambient temperature: 70°C 158°F

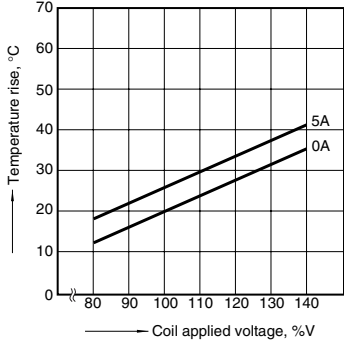

DIMENSIONS (Unit: mm inch)

1. Plug-in type 1 Form C

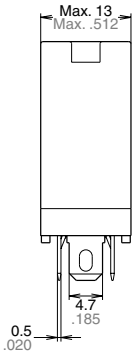

External dimensions

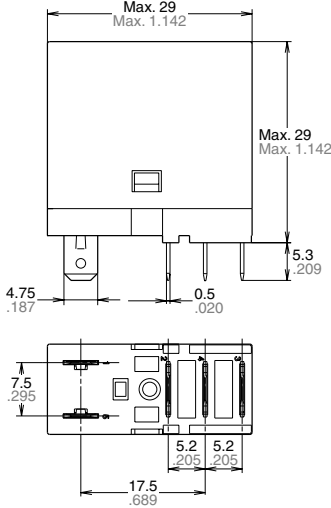

Schematic (Bottom view)
Standard type

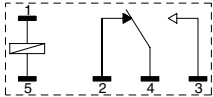

With LED AC type

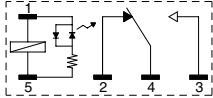

With LED DC type

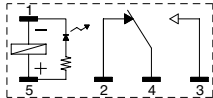

With Diode type

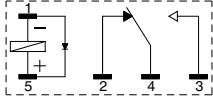

With Diode and LED type

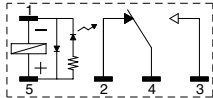

Dimension :	Tolerance
Max. 1mm .039 inch:	±0.1 ±.004
1 to 3mm .039 to .118 inch:	±0.2 ±.008
Min. 3mm .118 inch:	±0.3 ±.012

2. Plug-in type 2 Form C

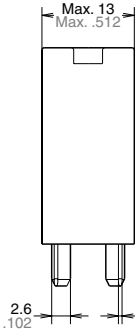

External dimensions

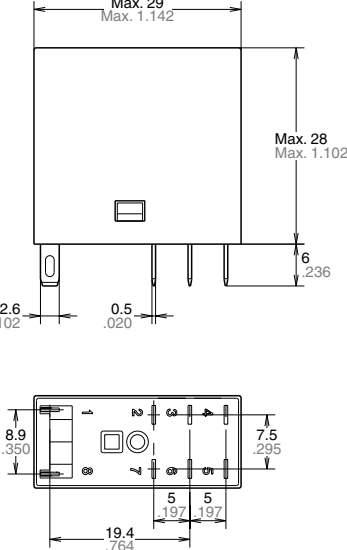

Schematic (Bottom view)
Standard type

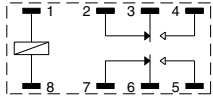

With LED AC type

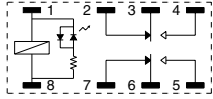

With LED DC type

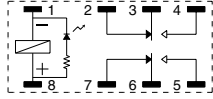

With Diode type

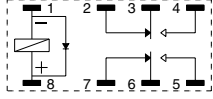

With Diode and LED type

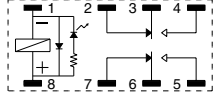

Dimension :	Tolerance
Max. 1mm .039 inch:	±0.1 ±.004
1 to 3mm .039 to .118 inch:	±0.2 ±.008
Min. 3mm .118 inch:	±0.3 ±.012

HN (AHN)

3. TM type 1 Form A

External dimensions

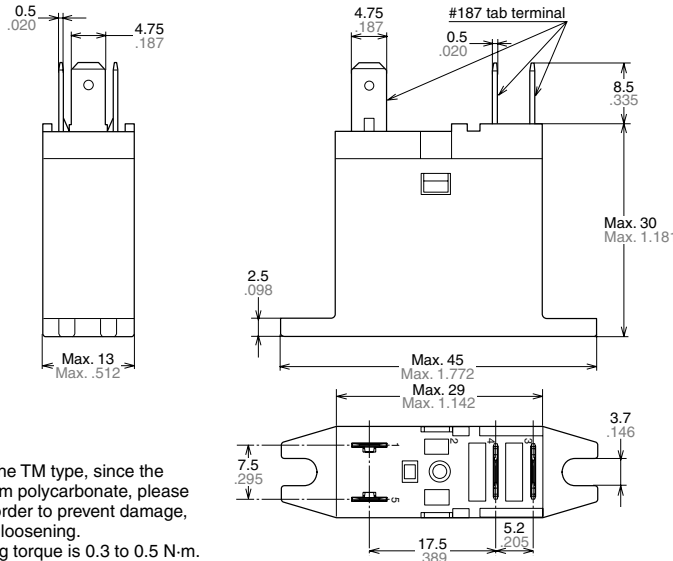

Notes: 1. When mounting the TM type, since the cover is made from polycarbonate, please use a washer in order to prevent damage, deformation, and loosening.
2. Suitable tightening torque is 0.3 to 0.5 N·m.

Schematic

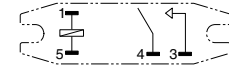

Mounting hole dimensions

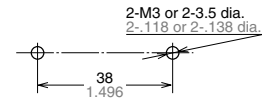

Dimension :	Tolerance
Max. 1mm .039 inch:	±0.1 ±0.004
1 to 3mm .039 to .118 inch:	±0.2 ±0.008
Min. 3mm .118 inch:	±0.3 ±0.012

4. HN1 Screw terminal socket

External dimensions

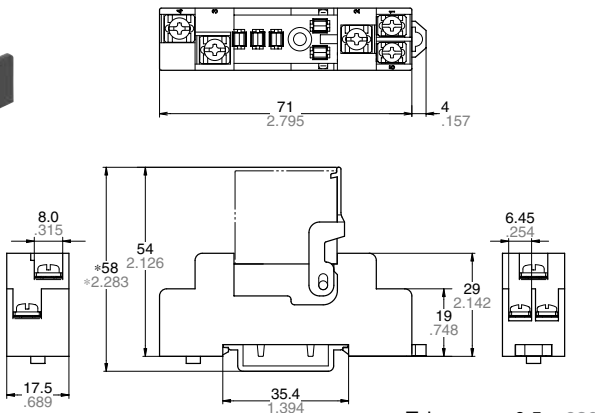
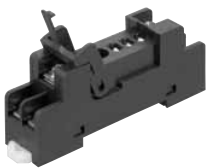

Tolerance: ±0.5 ±0.020

* Reference in case of using DIN rail (ATA48011)

Schematic (Top view)

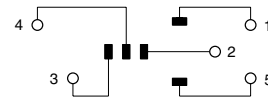

Mounting hole dimensions

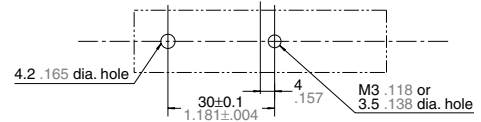

5. HN1 Screw terminal socket (Finger protect type)

External dimensions

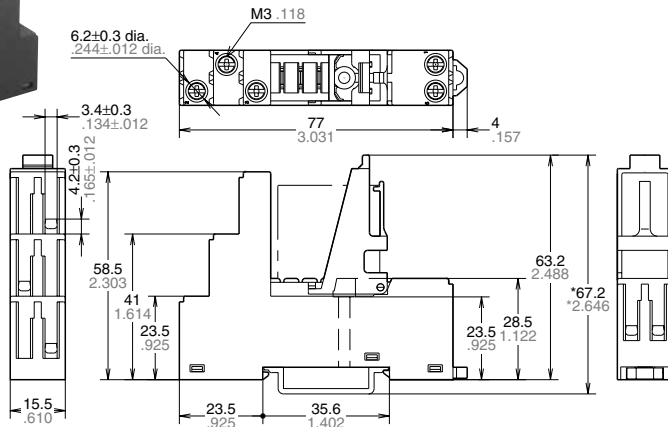
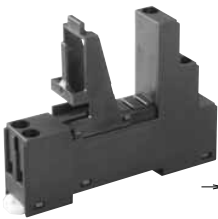

Tolerance: ±0.5 ±0.020

* Reference in case of using DIN rail (ATA48011)

Schematic (Top view)

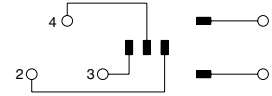

Mounting hole dimensions

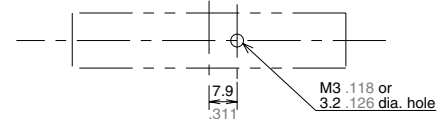

Note: Use rod or plate terminals, etc. (You cannot use Y-shape or round terminals.)

6. HN2 Screw terminal socket



External dimensions

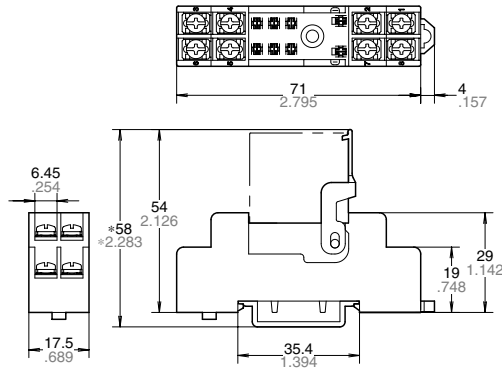

Tolerance: $\pm 0.5 \pm 0.020$

* Reference in case of using DIN rail (ATA48011)

Schematic (Top view)

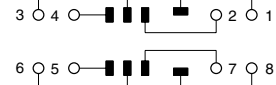

Mounting hole dimensions

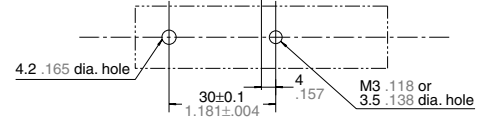

7. HN2 Screw terminal socket (Finger protect type)



External dimensions

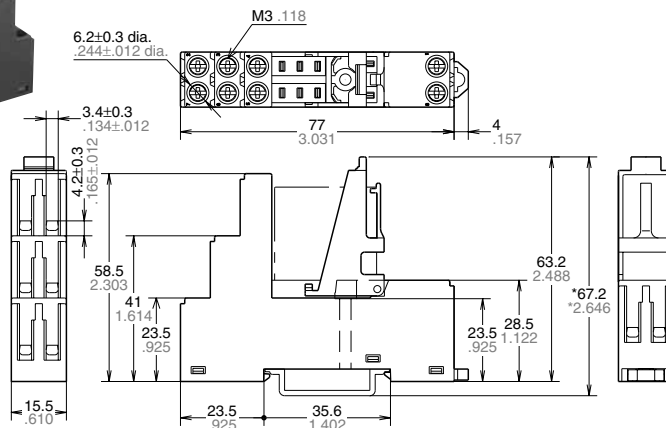

Tolerance: $\pm 0.5 \pm 0.020$

* Reference in case of using DIN rail (ATA48011)

Note: Use rod or plate terminals, etc. (You cannot use Y-shape or round terminals.)

Schematic (Top view)

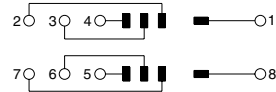

Mounting hole dimensions

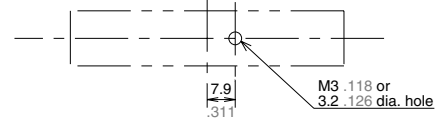

8. HN1 PC board terminal socket



External dimensions

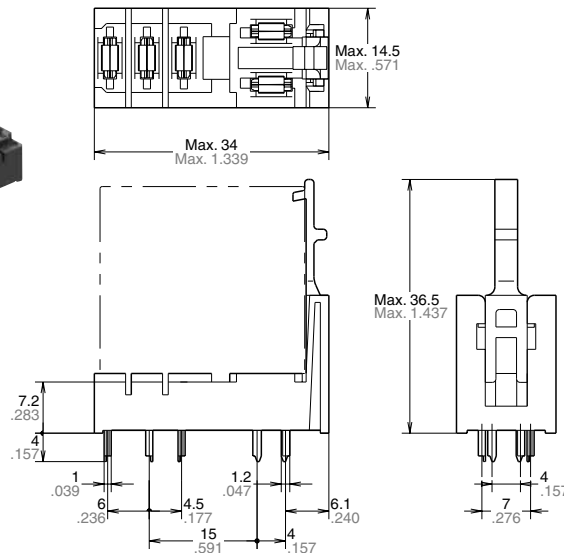

PC board pattern (Bottom view)

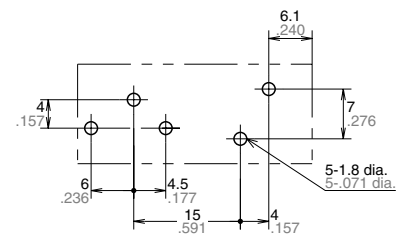

Tolerance: $\pm 0.1 \pm 0.004$

Dimension :	Tolerance
Max. 1mm .039 inch:	$\pm 0.1 \pm 0.004$
1 to 3mm .039 to .118 inch:	$\pm 0.2 \pm 0.008$
Min. 3mm .118 inch:	$\pm 0.3 \pm 0.012$

HN (AHN)

9. HN2 PC board terminal socket

External dimensions

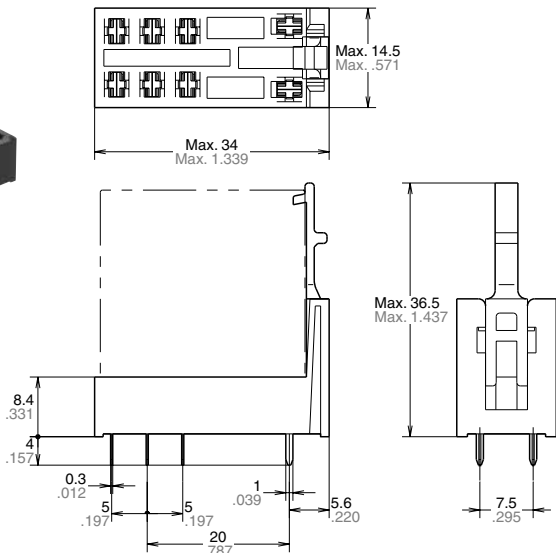

PC board pattern (Bottom view)

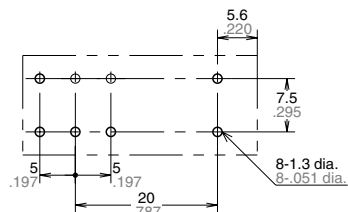

Tolerance: $\pm 0.1 \pm 0.04$

Dimension :	Tolerance
Max. 1mm .039 inch:	$\pm 0.1 \pm 0.04$
1 to 3mm .039 to .118 inch:	$\pm 0.2 \pm 0.08$
Min. 3mm .118 inch:	$\pm 0.3 \pm 0.12$

NOTES

1. Coil operating power

To ensure proper operation, the voltage applied to both terminals of the coil should be $\pm 5\%$ (at 20°C 68°F) the rated operating voltage of the coil.

Also, be aware that the pick-up and drop-out voltages will fluctuate depending on the ambient temperature and operating conditions.

2. LED indications

The light of the light emitting diode is what displays operation. If voltage remains after relay dropout, the LED might illuminate briefly.

3. Switching lifetime

The switching lifetime is defined under the standard test condition specified in the JIS C 5442(*2) standard (temperature 15 to 35°C 59 to 95°F , humidity 25 to 75% R.H.). Check this with the real device as it is affected by coil driving circuit, load type, activation frequency, activation phase, ambient conditions and other factors.

Also, be especially careful of loads such as those listed below.

1) When used for AC load-operating and the operating phase is synchronous. Rocking and fusing can easily occur due to contact shifting.

2) High-frequency load-operating When high-frequency opening and closing of the relay is performed with a load that causes arcs at the contacts, nitrogen and oxygen in the air is fused by the arc energy and HNO_3 is formed. This can corrode metal materials.

Three countermeasures for these are listed here.

(1) Incorporate an arc-extinguishing circuit.

(2) Lower the operating frequency

(3) Lower the ambient humidity

4. Direct mount type (TM type)

If the current to the connection terminal will exceed 10 A , we recommend connecting with solder. If you are going to use a tab terminal when the current will exceed 10 A , make sure to verify the temperature rise on the receptacle side under actual conditions before using.

5. Conditions for operation, transport and storage

1) Ambient temperature, humidity, and atmospheric pressure during usage, transport, and storage of the relay:

(1) Temperature: -40 to $+70^\circ\text{C}$ -40 to $+158^\circ\text{F}$

(2) Humidity: 5 to 85% RH (Avoid freezing and condensation.)

The humidity range varies with the temperature. Use within the range indicated in the graph below.

Temperature and humidity range for usage, transport, and storage

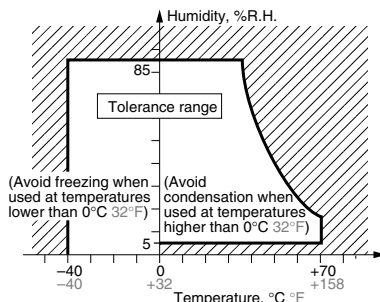

(3) Atmospheric pressure: 86 to 106 kPa

6. About the relay-securing hook

• Screw terminal socket

1) Installation of the securing hook is easily performed by pressing upward in the direction of the arrows.

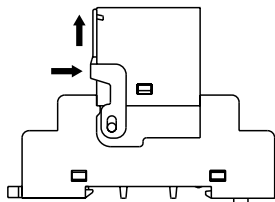

2) Removal of the securing hook is easily performed by releasing the hook and pressing down, as shown in the figure.

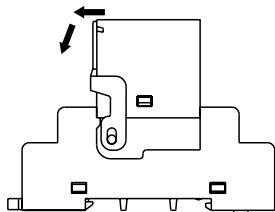

• Screw terminal socket

(Finger protect type)

1) Install the securing hook by pressing the parts with arrows after inserting the relay.

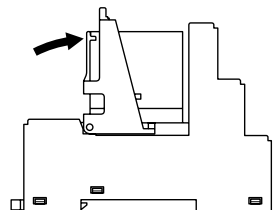

2) Removal of the relay is easily performed by pressing the parts with arrows.

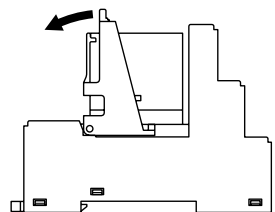

• PC board terminal socket

1) Installation of the securing hook is easily performed by pressing upward in the direction of the arrows.

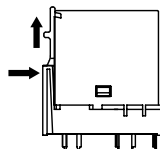

2) Removal of the securing hook is easily performed by releasing the hook and pressing down, as shown in the figure.

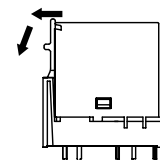

* To prevent damage and deformity, please use the relay-securing hook at 10 N or less.

7. Diode characteristics

1) Reverse breakdown voltage:

Min. 1,000V (with diode type)

Min. 400V (with diode and LED indication type)

8. Diode type

Since the diode inside the relay coil are designed to absorb the counter emf, the element may be damaged if a large surge, etc., is applied to the diode.

If there is the possibility of a large surge voltage from the outside, please implement measures to absorb it.

9. Installation

If you will be installing adjacent to other relays, please keep a distance of at least 5 mm from the relay.

For Cautions for Use, see Relay Technical Information.