

# ZB5CW143

red square projecting illum pushbutton head  
Ø22 spring return for integral LED



## Main

|                                 |                                 |
|---------------------------------|---------------------------------|
| Range of product                | Harmony XB5                     |
| Product or component type       | Head for illuminated pushbutton |
| Device short name               | ZB5                             |
| Product compatibility           | Integral LED                    |
| Bezel material                  | Plastic                         |
| Mounting diameter               | 22 mm                           |
| Sale per indivisible quantity   | 1                               |
| Shape of signaling unit head    | Square                          |
| Type of operator                | Spring return                   |
| Operator profile                | Red projecting unmarked         |
| Operator additional information | For insertion of legend         |

## Complementary

|                                    |                                      |
|------------------------------------|--------------------------------------|
| CAD overall width                  | 30 mm                                |
| CAD overall height                 | 30 mm                                |
| CAD overall depth                  | 34 mm                                |
| Product weight                     | 0.024 kg                             |
| Resistance to high pressure washer | 7000000 Pa at 55 °C, distance: 0.1 m |
| Mechanical durability              | 5000000 cycles                       |

## Environment

|  |  |
|--|--|
| Protective treatment                       | TC   |
| Ambient air temperature for storage        | -40...70 °C  |
| Ambient air temperature for operation      | -25...70 °C  |
| Class of protection against electric shock | Class II conforming to IEC 60536   |
| IP degree of protection                    | IP66 conforming to IEC 60529   |
| NEMA degree of protection                  | NEMA 13<br>NEMA 4X   |
| IK degree of protection                    | IK05 conforming to EN 50102  |
| Standards                                  | CSA C22-2 No 14<br>EN/IEC 60947-1<br>EN/IEC 60947-5-4<br>EN/IEC 60947-5-1<br>EN/IEC 60947-5-5<br>UL 508<br>JIS C 4520                                |
| Product certifications                     | DNV (Det Norske Veritas)<br>GL<br>UL listed<br>RINA<br>BV<br>LROS (Lloyds register of shipping)<br>CSA   |
| Vibration resistance                       | 5 gn (f = 2...500 Hz) conforming to IEC 60068-2-6  |
| Shock resistance                           | 50 gn for 11 ms half sine wave acceleration conforming to IEC 60068-2-27<br>30 gn for 18 ms half sine wave acceleration conforming to IEC 60068-2-27 |

The information provided in this documentation contains general descriptions and/or technical characteristics of the performance of the products contained herein. This documentation is not intended as a substitute for and is not to be used for determining suitability or reliability of these products for specific user applications. It is the duty of any such user or integrator to perform the appropriate and complete risk analysis, evaluation and testing of the products with respect to the relevant specific application or use thereof. Neither Schneider Electric Industries SAS nor any of its affiliates or subsidiaries shall be responsible or liable for misuse of the information contained herein.

Dimensions of Heads for Spring Return Illuminated Pushbuttons, for Light Source Types

LED

ZB5 AW3•3, ZB5 AW3•3S, ZB5 AA•8

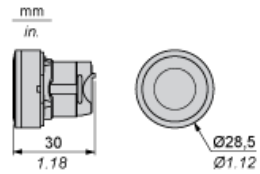

ZB5 AW1•3, ZB5 AW1•3S, ZB5 AL•8

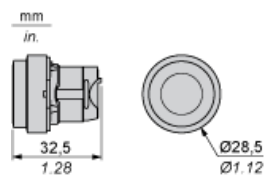

ZB5 AW9•3

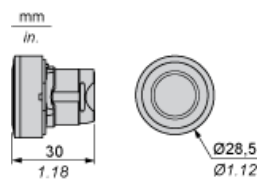

ZB5 AW5•3

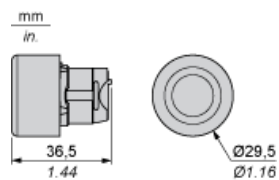

ZB5 CW3•3

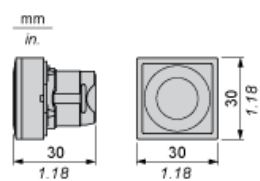

ZB5 CW1•3

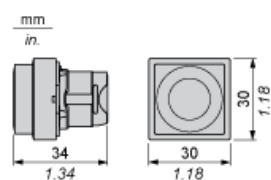

Bulb with BA9s Base Fitting

ZB5 AW3•, ZB5 AW3•S

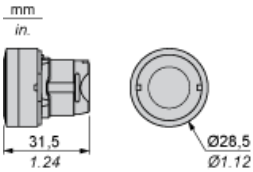

ZB5 AW1•, ZB5 AW1••S

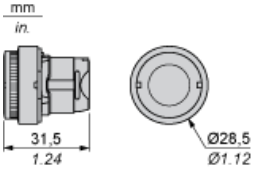

Panel Cut-out for Pushbuttons, Switches and Pilot Lights (Finished Holes, Ready for Installation)

Connection by Screw Clamp Terminals or Plug-in Connectors or on Printed Circuit Board

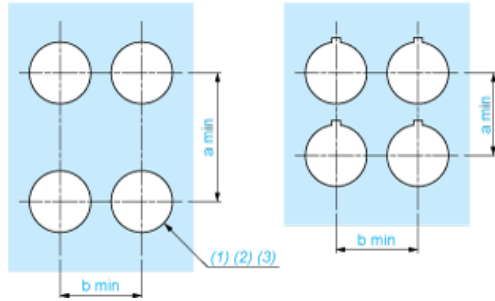

- (1) Diameter on finished panel or support
- (2) For selector switches and Emergency stop buttons, use of an anti-rotation plate type ZB5 AZ902 is recommended.
- (3)  $\varnothing 22.5$  mm recommended ( $\varnothing 22.3$   $0^{+0.4}$ ) /  $\varnothing 0.89$  in. recommended ( $\varnothing 0.88$  in.  $0^{+0.016}$ )

| Connections                                   | a in mm | a in in. | b in mm | b in in. |
|---|---------|----------|---------|----------|
| By screw clamp terminals or plug-in connector | 40      | 1.57     | 30      | 1.18     |
| By Faston connectors                          | 45      | 1.77     | 32      | 1.26     |
| On printed circuit board                      | 30      | 1.18     | 30      | 1.18     |

Detail of Lug Recess

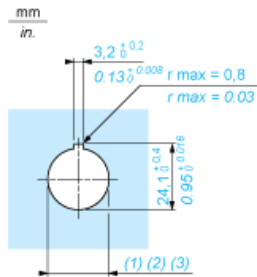

- (1) Diameter on finished panel or support
- (2) For selector switches and Emergency stop buttons, use of an anti-rotation plate type ZB5 AZ902 is recommended.
- (3)  $\varnothing 22.5$  mm recommended ( $\varnothing 22.3$   $0^{+0.4}$ ) /  $\varnothing 0.89$  in. recommended ( $\varnothing 0.88$  in.  $0^{+0.016}$ )

Pushbuttons, Switches and Pilot Lights for Printed Circuit Board Connection

Panel Cut-outs (Viewed from Installer's Side)

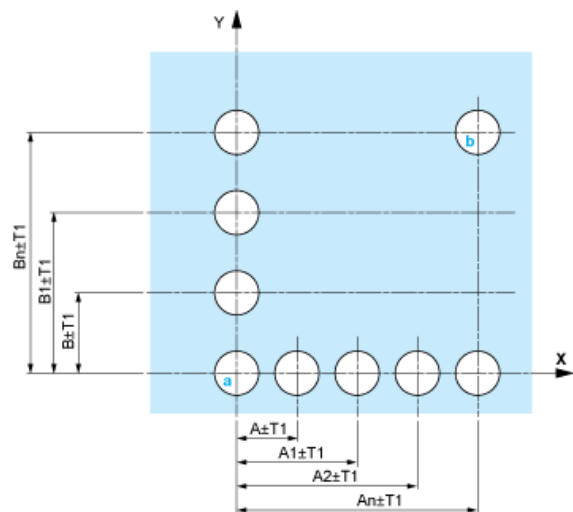

- A: 30 mm min. / 1.18 in. min.
- B: 40 mm min. / 1.57 in. min.

Printed Circuit Board Cut-outs (Viewed from Electrical Block Side)

Dimensions in mm

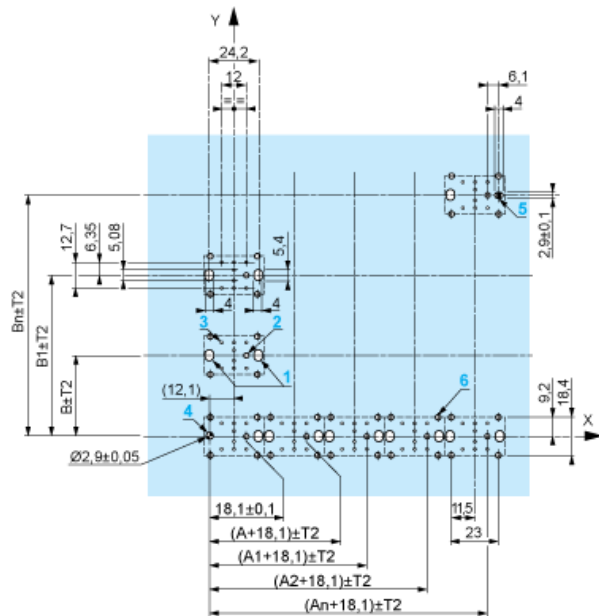

- A: 30 mm min.
- B: 40 mm min.

Dimensions in in.

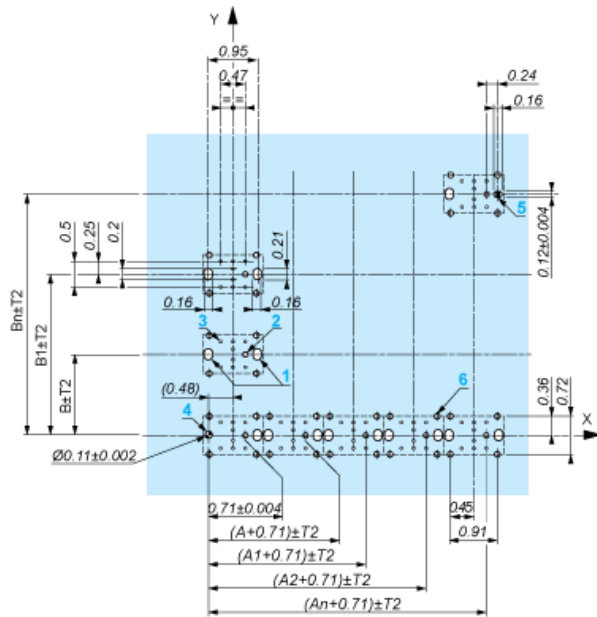

A: 1.18 in. min.  
B: 1.57 in. min.

### General Tolerances of the Panel and Printed Circuit Board

The cumulative tolerance must not exceed 0.3 mm / 0.012 in.:  $T1 + T2 = 0.3 \text{ mm max.}$

### Installation Precautions

- Minimum thickness of circuit board: 1.6 mm / 0.06 in.
- Cut-out diameter: 22.4 mm  $\pm$  0.1 / 0.88 in.  $\pm$  0.004
- Orientation of body/fixing collar ZB4 BZ009:  $\pm 2^\circ 30'$  (excluding cut-outs marked a and b).
- Tightening torque of screws ZBZ 006: 0.6 N.m. max.
- Allow for one ZB4 BZ079 fixing collar/pillar and its fixing screws:
  - every 90 mm / 3.54 in. horizontally (X), and 120 mm / 4.72 in. vertically (Y).
  - with each selector switch head (ZB5 AD\*, ZB5 AJ\*, ZB5 AG\*).

The fixing centers marked a and b are diagonally opposed and must align with those marked 4 and 5.

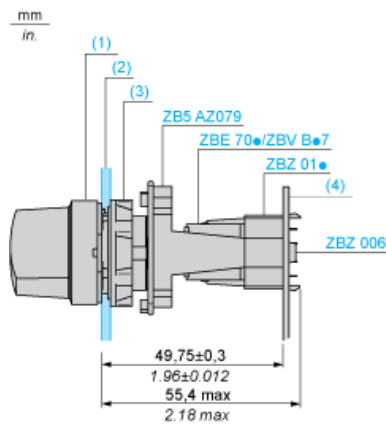

- (1) Head ZB5 AD\*  
(2) Panel  
(2) Nut  
(4) Printed circuit board

### Mounting of Adapter (Socket) ZBZ 01•

- 1 2 elongated holes for ZBZ 006 screw access
- 2 1 hole  $\varnothing$  2.4 mm  $\pm$  0.05 / 0.09 in.  $\pm$  0.002 for centring adapter ZBZ 01•
- 3 8  $\times$   $\varnothing$  1.2 mm / 0.05 in. holes
- 4 1 hole  $\varnothing$  2.9 mm  $\pm$  0.05 / 0.11 in.  $\pm$  0.002, for aligning the printed circuit board (with cut-out marked a)
- 5 1 elongated hole for aligning the printed circuit board (with cut-out marked b)
- 6 4 holes  $\varnothing$  2.4 mm / 0.09 in. for clipping in adapter ZBZ 01•

Dimensions An + 18.1 relate to the  $\varnothing 2.4 \text{ mm} \pm 0.05 / 0.09 \text{ in.} \pm 0.002$  holes for centring adapter ZBZ 01•.