



Main

Range of product	Harmony XB5
Product or component type	Head for non-illuminated pushbutton
Device short name	ZB5
Bezel material	Plastic
Mounting diameter	22 mm
Sale per indivisible quantity	1
Shape of signaling unit head	Square
Type of operator	Push-push
Operator profile	Blue flush unmarked

Complementary

CAD overall width	30 mm
CAD overall height	30 mm
CAD overall depth	28 mm
Product weight	0.02 kg
Resistance to high pressure washer	7000000 Pa at 55 °C, distance: 0.1 m
Mechanical durability	500000 cycles

Environment

Protective treatment	TH
Ambient air temperature for storage	-40...70 °C
Ambient air temperature for operation	-25...70 °C
Class of protection against electric shock	Class II conforming to IEC 60536
IP degree of protection	IP66 conforming to IEC 60529
NEMA degree of protection	NEMA 13 NEMA 4X
IK degree of protection	IK03 conforming to IEC 50102
Standards	EN/IEC 60947-5-1 UL 508 EN/IEC 60947-5-4 EN/IEC 60947-1 CSA C22-2 No 14 EN/IEC 60947-5-5 JIS C 4520
Product certifications	DNV (Det Norske Veritas) BV CSA RINA UL listed LROS (Lloyds register of shipping) GL
Vibration resistance	5 gn (f = 2...500 Hz) conforming to IEC 60068-2-6
Shock resistance	30 gn for 18 ms half sine wave acceleration conforming to IEC 60068-2-27 50 gn for 11 ms half sine wave acceleration conforming to IEC 60068-2-27

The information provided in this documentation contains general descriptions and/or technical characteristics of the performance of the products contained herein. This documentation is not intended as a substitute for and is not to be used for determining suitability or reliability of these products for specific user applications. It is the duty of any such user or integrator to perform the appropriate and complete risk analysis, evaluation and testing of the products with respect to the relevant specific application or use thereof. Neither Schneider Electric Industries SAS nor any of its affiliates or subsidiaries shall be responsible or liable for misuse of the information contained herein.

Dimensions of Heads for "Push-Push to Release" Pushbuttons

Heads for "Push-Push to Release" Pushbuttons

ZB5 AH0•

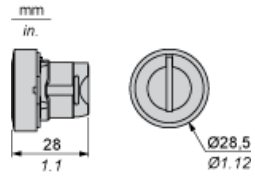

ZB5 AH•

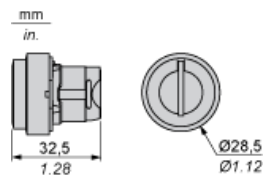

ZB5 CH0•

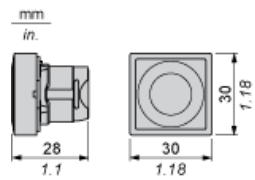

Panel Cut-out for Pushbuttons, Switches and Pilot Lights (Finished Holes, Ready for Installation)

Connection by Screw Clamp Terminals or Plug-in Connectors or on Printed Circuit Board

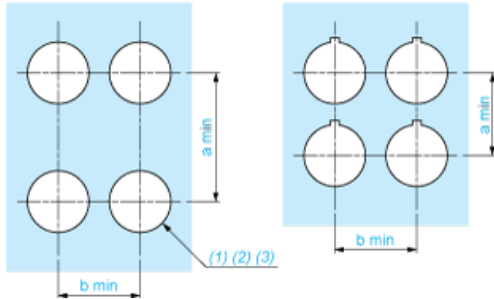

- (1) Diameter on finished panel or support
- (2) For selector switches and Emergency stop buttons, use of an anti-rotation plate type ZB5 AZ902 is recommended.
- (3) $\varnothing 22.5$ mm recommended ($\varnothing 22.3 \text{ }_0^{+0.4}$) / $\varnothing 0.89$ in. recommended ($\varnothing 0.88$ in. $_0^{+0.016}$)

Connections	a in mm	a in in.	b in mm	b in in.
By screw clamp terminals or plug-in connector	40	1.57	30	1.18
By Faston connectors	45	1.77	32	1.26
On printed circuit board	30	1.18	30	1.18

Detail of Lug Recess

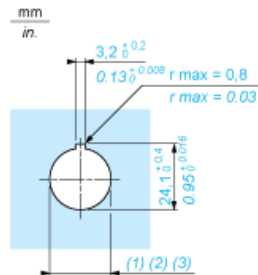

- (1) Diameter on finished panel or support
- (2) For selector switches and Emergency stop buttons, use of an anti-rotation plate type ZB5 AZ902 is recommended.
- (3) $\varnothing 22.5$ mm recommended ($\varnothing 22.3 \text{ }_0^{+0.4}$) / $\varnothing 0.89$ in. recommended ($\varnothing 0.88$ in. $_0^{+0.016}$)

Pushbuttons, Switches and Pilot Lights for Printed Circuit Board Connection

Dimensions in in.

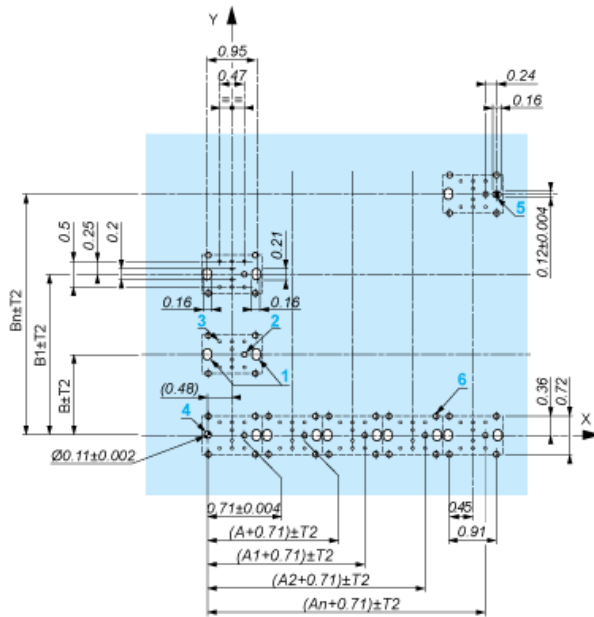

A: 1.18 in. min.
B: 1.57 in. min.

General Tolerances of the Panel and Printed Circuit Board

The cumulative tolerance must not exceed 0.3 mm / 0.012 in.: $T_1 + T_2 = 0.3 \text{ mm max.}$

Installation Precautions

- Minimum thickness of circuit board: 1.6 mm / 0.06 in.
- Cut-out diameter: 22.4 mm \pm 0.1 / 0.88 in. \pm 0.004
- Orientation of body/fixing collar ZB4 BZ009: $\pm 2^\circ 30'$ (excluding cut-outs marked a and b).
- Tightening torque of screws ZBZ 006: 0.6 N.m. max.
- Allow for one ZB4 BZ079 fixing collar/pillar and its fixing screws:
 - every 90 mm / 3.54 in. horizontally (X), and 120 mm / 4.72 in. vertically (Y).
 - with each selector switch head (ZB5 AD•, ZB5 AJ•, ZB5 AG•).

The fixing centers marked a and b are diagonally opposed and must align with those marked 4 and 5.

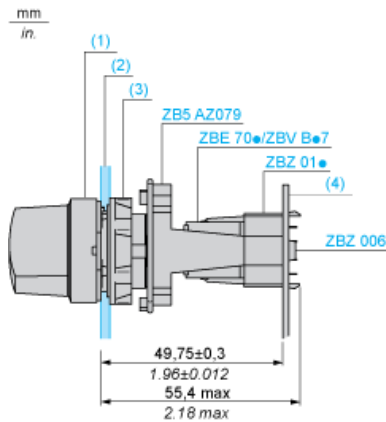

- (1) Head ZB5 AD•
(2) Panel
(2) Nut
(4) Printed circuit board

Mounting of Adapter (Socket) ZBZ 01•

- 1 2 elongated holes for ZBZ 006 screw access
- 2 1 hole \varnothing 2.4 mm \pm 0.05 / 0.09 in. \pm 0.002 for centring adapter ZBZ 01•
- 3 8 \times \varnothing 1.2 mm / 0.05 in. holes
- 4 1 hole \varnothing 2.9 mm \pm 0.05 / 0.11 in. \pm 0.002, for aligning the printed circuit board (with cut-out marked a)
- 5 1 elongated hole for aligning the printed circuit board (with cut-out marked b)
- 6 4 holes \varnothing 2.4 mm / 0.09 in. for clipping in adapter ZBZ 01•

Dimensions An + 18.1 relate to the $\varnothing 2.4 \text{ mm} \pm 0.05 / 0.09 \text{ in.} \pm 0.002$ holes for centring adapter ZBZ 01•.