

GP Series Sealed Ultraminiature Pushbutton Switches



A
Pushbutton

Features/Benefits

- Ultraminiature design saves space
- Process compatible, withstands most soldering and washing processes
- Thru-hole and surface mount models available
- Sealed construction—internal o-ring and epoxy base
- RoHS compliant

Typical Applications

- Telecommunications and network equipment
- Computers and peripheral products
- Instrumentation
- Medical Applications



Specifications

CONTACT RATING: 0.4 VA max. @ 20 V AC or DC max.
 MECHANICAL & ELECTRICAL LIFE: 40,000 make-and-break cycles at full load.
 CONTACT RESISTANCE: Below 50 mΩ typ. initial @ 2-4 V DC, 100 mA.
 INSULATION RESISTANCE: 10⁹Ω min.
 DIELECTRIC STRENGTH: 500 Vrms min. @ sea level.
 OPERATING TEMPERATURE: -30°C to 85°C.
 SOLDERABILITY: Per MIL-STD-202F method 208D, or EIA RS-186E method 9 (1 hour steam aging).
 DEGREE OF PROTECTION: IP57; Protection against harmful dust deposit, full-scale voltage protection, temporary immersion.
 PACKAGING: Surface mount switches standard in anti-static tape and reel packaging per EIA 481-3, see page A-80 for drawings and reel information. Thru-Hole parts are shipped in trays.
 All models are RoHS compliant and compliant.

Materials

HOUSING & BASE: Glass filled nylon 4/6, flame retardant, heat stabilized (UL 94V-0).
 ACTUATOR: Glass filled nylon 4/6, flame retardant (UL 94V-0) with standard internal o-ring seal.
 SWITCH SUPPORT: Brass, tin plated.
 MOVABLE CONTACT: Copper alloy, with gold plate over nickel plate.
 STATIONARY CONTACTS Copper alloy, with gold plate over nickel plate.
 TERMINALS: Copper alloy, with gold flash over nickel plate.
 TERMINAL SEAL: Epoxy/Urethane. All terminals insert molded.

NOTE: Any models supplied with B contact material are RoHS compliant and compatible.

NOTE: Materials listed above are general specifications. Specifications available for specific and custom switches, consult Customer Service Center.

CAUTION: PC mounting layouts and pads as shown are designed to be compatible with the latest equipment and reflow techniques. Care should be taken in the design and location of PC lands to suit individual needs. Orientation relative to reflow direction may significantly impact solder joint integrity.

How To Order

Complete part numbers for GP Series Sealed Ultraminiature Pushbutton Switches are shown on pages A-78 thru A-80.

PART NUMBER	SWITCH FUNCTION		SCHEMATIC
	POS.1	POS. 2	
GP11MCBE	OFF	MOM.	
Conn. Terms.	OPEN	1-3	SPST
GP12MCBE	ON	MOM.	
Conn. Terms.	2-1	2-3	SPDT

MOM. = Momentary

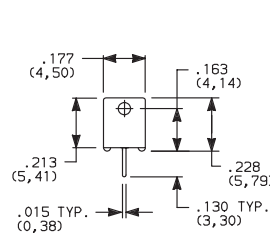

PC MOUNTING



GP11—omit center hole.

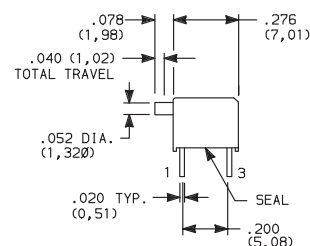

Terminal nos. for reference only.

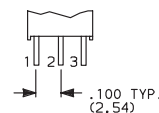

GP12 Model



GP11MCBE SPST



Dimensions are shown: Inches (mm)
 Specifications and dimensions subject to change



GP Series Sealed Ultraminiature Pushbutton Switches

A

Pushbutton



GP11MABE
SPST

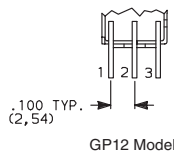
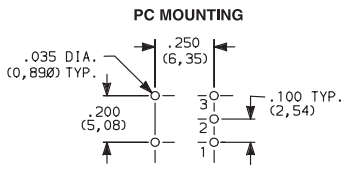
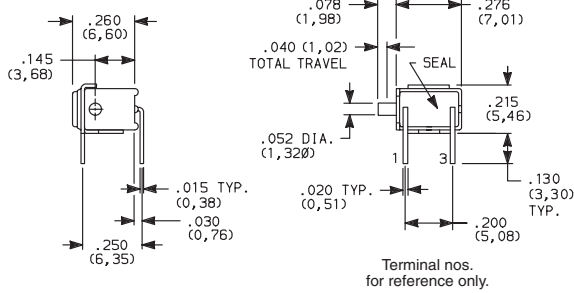

PART NUMBER	SWITCH FUNCTION		SCHEMATIC
	POS.1	POS. 2	
GP11MABE	OFF	MOM.	
Conn. Terms.	OPEN	1-3	
GP12MABE	ON	MOM.	
Conn. Terms.	2-1	2-3	

MOM. = Momentary



GP11MSABE
SPST

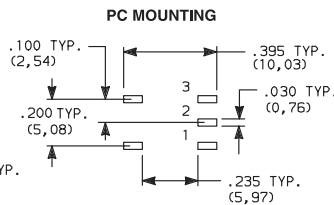
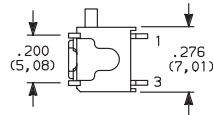
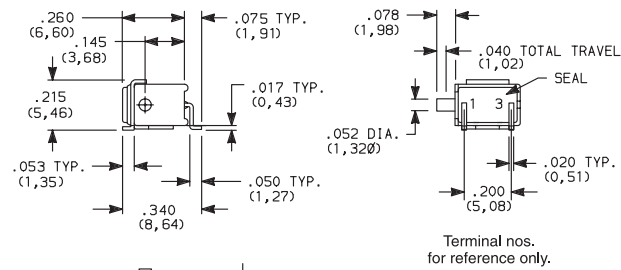

PART NUMBER	SWITCH FUNCTION		SCHEMATIC
	POS.1	POS. 2	
GP11MSABE	OFF	MOM.	
Conn. Terms.	OPEN	1-3	
GP12MSABE	ON	MOM.	
Conn. Terms.	2-1	2-3	

MOM. = Momentary



GP11MSA1BE
SPST

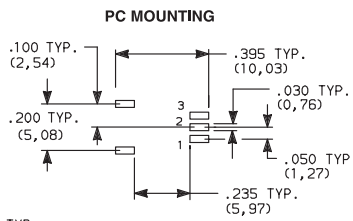
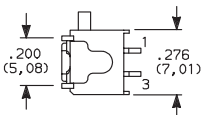
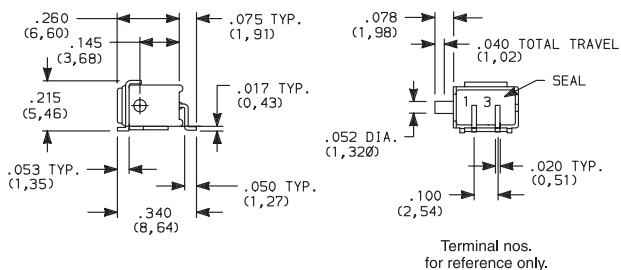

PART NUMBER	SWITCH FUNCTION		SCHEMATIC
	POS.1	POS. 2	
GP11MSA1BE	OFF	MOM.	
Conn. Terms.	OPEN	1-3	
GP12MSA1BE	ON	MOM.	
Conn. Terms.	2-1	2-3	

MOM. = Momentary

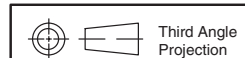

Dimensions are shown: Inches (mm)
Specifications and dimensions subject to change



GP Series Sealed Ultraminiature Pushbutton Switches



PART NUMBER	SWITCH FUNCTION		SCHEMATIC
	POS.1	POS. 2	
GP12MSCBE	ON	MOM.	 NC 1 ● 2 (COMM) ● 3 NO
Conn. Terms.	2-1	2-3	

MOM. = Momentary

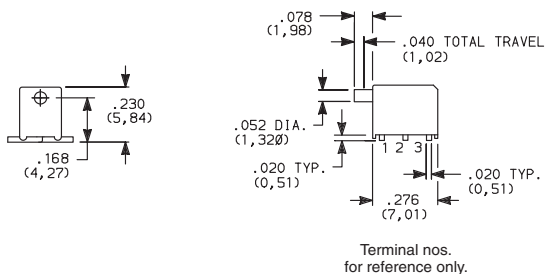

GP12MSCBE SPDT

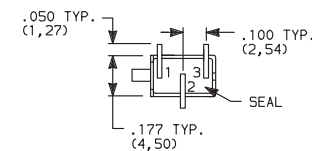
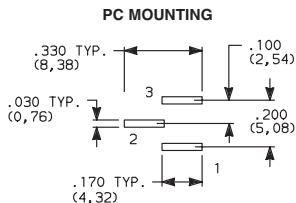

NOTE: Recommended for infrequent use applications only
For increased switch mounting strength, order, SV1 termination style with support bracket (see below).

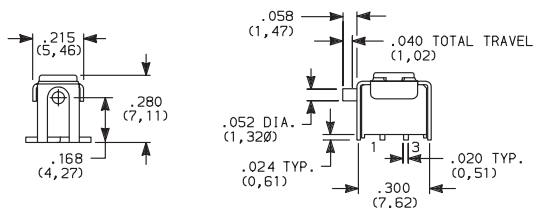

GP11MSV1BE SPST

PART NUMBER	SWITCH FUNCTION		SCHEMATIC
	POS.1	POS. 2	
GP11MSV1BE	OFF	MOM.	 1 ● 3
Conn. Terms.	OPEN	1-3	
GP12MSV1BE	ON	MOM.	 NC 1 ● 2 (COMM) ● 3 NO
Conn. Terms.	2-1	2-3	

MOM. = Momentary

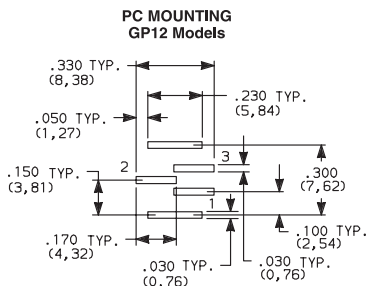
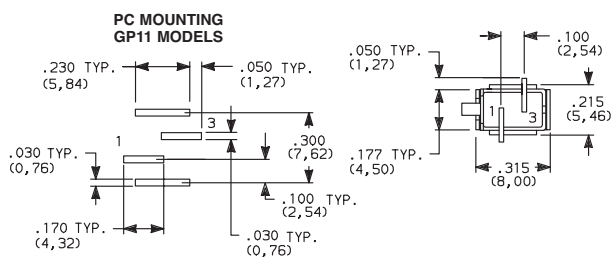

Terminal nos. for reference only.

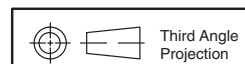

Dimensions are shown: Inches (mm)
Specifications and dimensions subject to change





Pushbutton
A

GP Series Sealed Ultraminiature Pushbutton Switches

TAPE & REEL

For part numbers GP11MSV1BE, GP12MSV1BE

REEL INFORMATION	
OUTSIDE DIAMETER	13.00 (330,0)
PILOT HOLE	.512 (13,0)
QUANTITY PER REEL	600

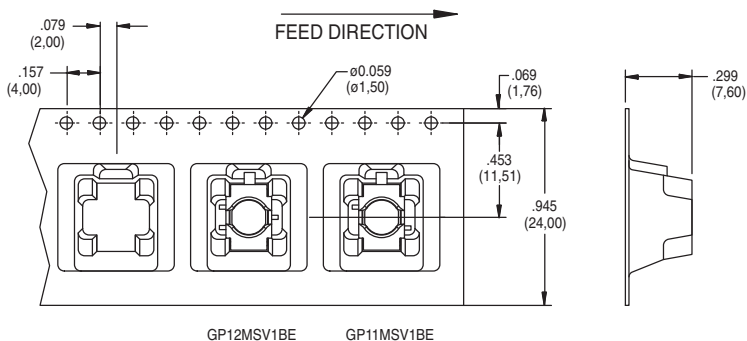

For part numbers GPXXSA1BE, GPXXMSABE

REEL INFORMATION	
OUTSIDE DIAMETER	13.00 (330,0)
PILOT HOLE	.512 (13,0)
QUANTITY PER REEL	600

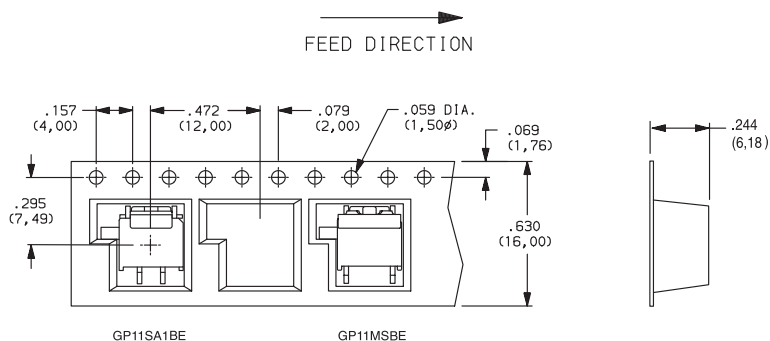

For part numbers GP12MSCBE

REEL INFORMATION	
OUTSIDE DIAMETER	13.00 (330,0)
PILOT HOLE	.512 (13,0)
QUANTITY PER REEL	600

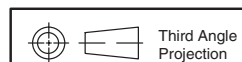
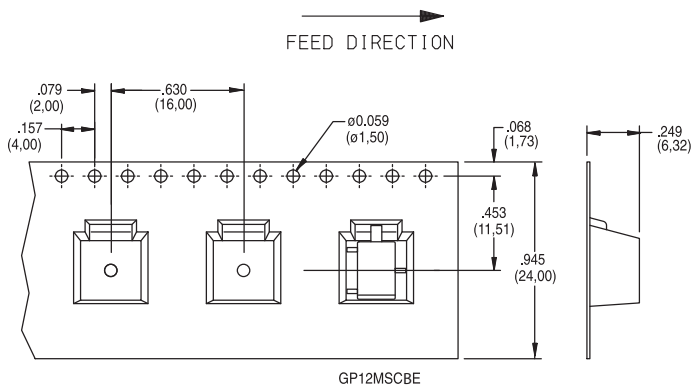

Dimensions are shown: Inches (mm)
Specifications and dimensions subject to change

