

P-Channel 20-V (D-S) MOSFET With Schottky Diode

MOSFET PRODUCT SUMMARY			
V_{DS} (V)	$r_{DS(on)}$ (Ω)	I_D (A) ^a	Q_g (Typ)
- 20	0.058 at $V_{GS} = -4.5$ V	6	5.5 nC
	0.100 at $V_{GS} = -2.5$ V	6	

SCHOTTKY PRODUCT SUMMARY		
V_{KA} (V)	V_f (V) Diode Forward Voltage	I_F (A) ^a
20	0.375 at 1 A	2

FEATURES

- LITTLE FOOT® Plus Power MOSFET
- New Thermally Enhanced PowerPAK® ChipFET® Package
 - Small Footprint Area
 - Low On-Resistance
 - Thin 0.8 mm Profile



RoHS
COMPLIANT

APPLICATIONS

- Charging Switch for Portable Devices
 - With Integrated Low V_f Trench Schottky Diode

PowerPAK® ChipFET® Dual

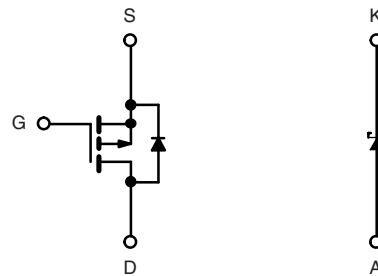
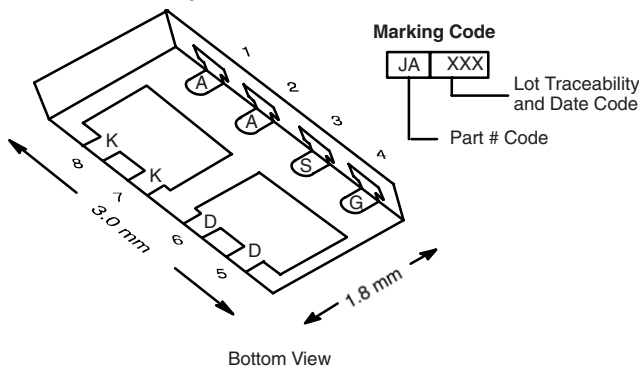

P-Channel MOSFET

Ordering Information: Si5857DU-T1-E3 (Lead (Pb)-free)

ABSOLUTE MAXIMUM RATINGS $T_A = 25$ °C, unless otherwise noted				
Parameter	Symbol	Limit	Unit	
Drain-Source Voltage (MOSFET)	V_{DS}	- 20	V	
Reverse Voltage (Schottky)	V_{KA}	20		
Gate-Source Voltage (MOSFET)	V_{GS}	± 12		
Continuous Drain Current ($T_J = 150$ °C) (MOSFET)	I_D	$T_C = 25$ °C	A	6 ^a
		$T_C = 70$ °C		6 ^a
		$T_A = 25$ °C		- 5 ^{b, c}
		$T_A = 70$ °C		- 4 ^{b, c}
Pulsed Drain Current (MOSFET)	I_{DM}	- 20		
Continuous Source Current (MOSFET Diode Conduction)	I_S	$T_C = 25$ °C	- 6 ^a	
		$T_A = 25$ °C	1.9 ^{b, c}	
Average Forward Current (Schottky)	I_F	2		
Pulsed Forward Current (Schottky)	I_{FM}	7		
Maximum Power Dissipation (MOSFET)	P_D	$T_C = 25$ °C	W	10.4
		$T_C = 70$ °C		6.7
		$T_A = 25$ °C		2.3 ^{b, c}
		$T_A = 70$ °C		1.5 ^{b, c}
Maximum Power Dissipation (Schottky)	P_D	$T_C = 25$ °C	W	7.8
		$T_C = 70$ °C		5
		$T_A = 25$ °C		2.1
		$T_A = 70$ °C		1.3
Operating Junction and Storage Temperature Range	T_J, T_{stg}	- 55 to 150	°C	
Soldering Recommendation (Peak Temperature) ^{d, e}		260		

THERMAL RESISTANCE RATINGS

Parameter	Symbol	Typical	Maximum	Unit
Maximum Junction-to-Ambient (MOSFET) ^{b, f}	R_{thJA}	43	55	°C/W
Maximum Junction-to-Case (Drain) (MOSFET)	R_{thJC}	9.5	12	
Maximum Junction-to-Ambient (Schottky) ^{b, g}	R_{thJA}	49	61	
Maximum Junction-to-Case (Drain) (Schottky)	R_{thJC}	13	16	

Notes:

a. Package limited.

b. Surface Mounted on FR4 Board.

c. $t \leq 5$ sec.d. See Solder Profile (<http://www.vishay.com/doc?73257>). The PowerPAK ChipFET is a leadless package. The end of the lead terminal is exposed copper (not plated) as a result of the singulation process in manufacturing. A solder fillet at the exposed copper tip cannot be guaranteed and is not required to ensure adequate bottom side solder interconnection. Rework Conditions: manual soldering with a soldering iron is not recommended for leadless components.

e. Rework Conditions: manual soldering with a soldering iron is not recommended for leadless components.

f. Maximum under Steady State conditions for MOSFETS is 105 °C/W.

g. Maximum under Steady State conditions for Schottky is 110 °C/W.

SPECIFICATIONS $T_J = 25$ °C, unless otherwise noted

Parameter	Symbol	Test Conditions	Min	Typ	Max	Unit
Static						
Drain-Source Breakdown Voltage	V_{DS}	$V_{GS} = 0$ V, $I_D = -250$ μ A	-20			V
V_{DS} Temperature Coefficient	$\Delta V_{DS/TJ}$	$I_D = -250$ μ A		-19		mV/°C
$V_{GS(th)}$ Temperature Coefficient	$\Delta V_{GS(th)/TJ}$		2.6			
Gate-Source Threshold Voltage	$V_{GS(th)}$	$V_{DS} = V_{GS}$, $I_D = -250$ μ A	-0.6		-1.5	V
Gate-Body Leakage	I_{GSS}	$V_{DS} = 0$ V, $V_{GS} = \pm 12$ V			± 100	ns
Zero Gate Voltage Drain Current	I_{DSS}	$V_{DS} = -20$ V, $V_{GS} = 0$ V			-1	μ A
		$V_{DS} = -20$ V, $V_{GS} = 0$ V, $T_J = 55$ °C			-10	
On-State Drain Current ^a	$I_{D(on)}$	$V_{DS} \leq -5$ V, $V_{GS} = -4.5$ V	-20			A
Drain-Source On-State Resistance ^a	$r_{DS(on)}$	$V_{GS} = -4.5$ V, $I_D = -3.6$ A		0.048	0.058	Ω
		$V_{GS} = -2.5$ V, $I_D = -1$ A		0.081	0.100	
Forward Transconductance ^a	g_{fs}	$V_{DS} = -10$ V, $I_D = -3.6$ A		10		S
Dynamic^b						
Input Capacitance	C_{iss}	$V_{DS} = -10$ V, $V_{GS} = 0$ V, $f = 1$ MHz		480		pF
Output Capacitance	C_{oss}		125			
Reverse Transfer Capacitance	C_{rss}		90			
Total Gate Charge	Q_g	$V_{DS} = -10$ V, $V_{GS} = -10$ V, $I_D = -5$ A		11	17	nC
				5.5	8.5	
Gate-Source Charge	Q_{gs}	$V_{DS} = -10$ V, $V_{GS} = -4.5$ V, $I_D = -5$ A		1.2		
Gate-Drain Charge	Q_{gd}			1.8		
Gate Resistance	R_g	$f = 1$ MHz		9		Ω
Turn-On Delay Time	$t_{d(on)}$	$V_{DD} = -10$ V, $R_L = 2.5$ Ω $I_D \cong -4$ A, $V_{GEN} = -4.5$ V, $R_g = 1$ Ω		11	20	ns
Rise Time	t_r			42	65	
Turn-Off Delay Time	$t_{d(off)}$			33	50	
Fall Time	t_f			50	75	
Turn-On Delay Time	$t_{d(on)}$	$V_{DD} = -10$ V, $R_L = 2.5$ Ω $I_D \cong -4$ A, $V_{GEN} = -10$ V, $R_g = 1$ Ω		5	10	
Rise Time	t_r			15	25	
Turn-Off Delay Time	$t_{d(off)}$			25	40	
Fall Time	t_f			10	20	



SPECIFICATIONS $T_J = 25\text{ }^\circ\text{C}$, unless otherwise noted						
Parameter	Symbol	Test Conditions	Min	Typ	Max	Unit
Drain-Source Body Diode Characteristics						
Continuous Source-Drain Diode Current	I_S	$T_C = 25\text{ }^\circ\text{C}$			- 6	A
Pulse Diode Forward Current	I_{SM}				- 20	
Body Diode Voltage	V_{SD}	$I_S = - 4\text{ A}, V_{GS} = 0\text{ V}$		- 0.9	- 1.2	V
Body Diode Reverse Recovery Time	t_{rr}	$I_F = - 4\text{ A di/dt} = 100\text{ A}/\mu\text{s } T_J = 25\text{ }^\circ\text{C}$		25	50	ns
Body Diode Reverse Recovery Charge	Q_{rr}			10	20	nC
Reverse Recovery Fall Time	t_a			9		ns
Reverse Recovery Rise Time	t_b			16		

Notes:

- a. Pulse test; pulse width $\leq 300\text{ }\mu\text{s}$, duty cycle $\leq 2\%$.
- b. Guaranteed by design, not subject to production testing.

SCHOTTKY SPECIFICATIONS $T_J = 25\text{ }^\circ\text{C}$, unless otherwise noted						
Parameter	Symbol	Test Conditions	Min	Typ	Max	Unit
Forward Voltage Drop	V_F	$I_F = 1\text{ A}$		0.34	0.375	V
		$I_F = 1\text{ A}, T_J = 125\text{ }^\circ\text{C}$		0.255	0.290	
Maximum Reverse Leakage Current	I_{rm}	$V_r = 20\text{ V}$		0.05	0.500	mA
		$V_r = 20\text{ V}, T_J = 85\text{ }^\circ\text{C}$		2	20	
		$V_r = 20\text{ V}, T_J = 125\text{ }^\circ\text{C}$		10	100	
Junction Capacitance	C_T	$V_r = 10\text{ V}$		90		pF

Stresses beyond those listed under "Absolute Maximum Ratings" may cause permanent damage to the device. These are stress ratings only, and functional operation of the device at these or any other conditions beyond those indicated in the operational sections of the specifications is not implied. Exposure to absolute maximum rating conditions for extended periods may affect device reliability.

MOSFET TYPICAL CHARACTERISTICS 25 °C, unless otherwise noted

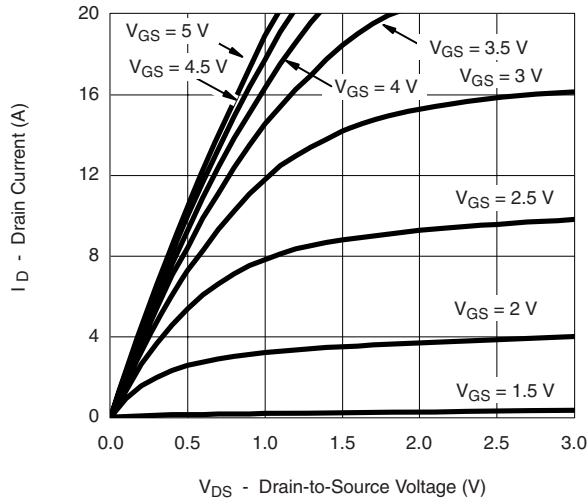

Output Characteristics

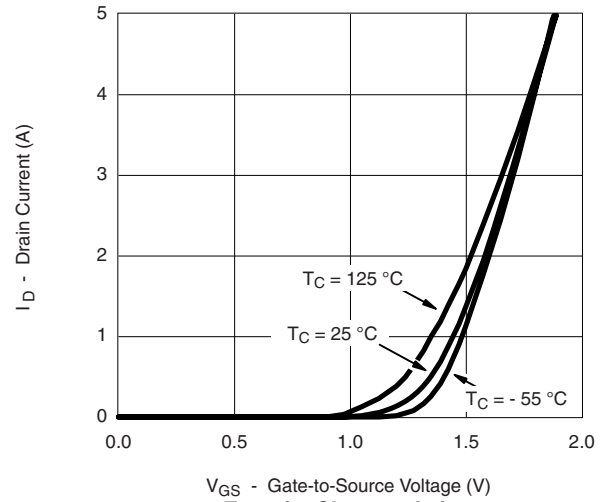

Transfer Characteristics

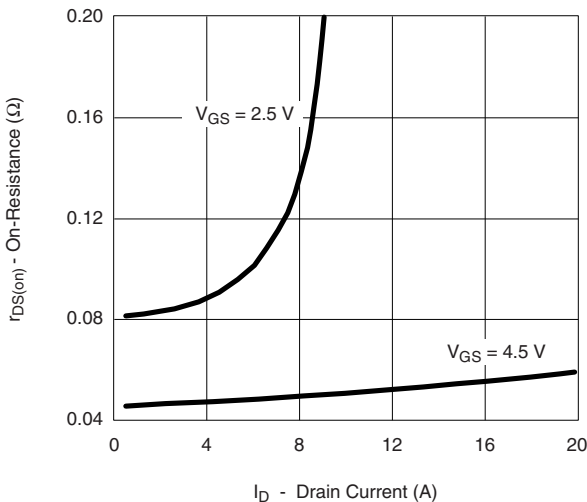

On-Resistance vs. Drain Current and Gate Voltage

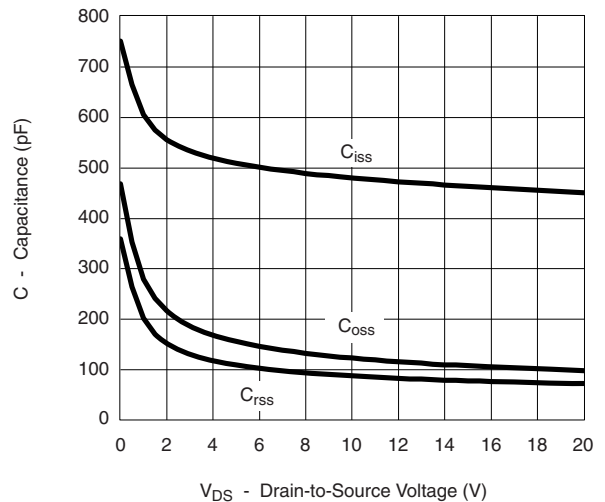

Capacitance

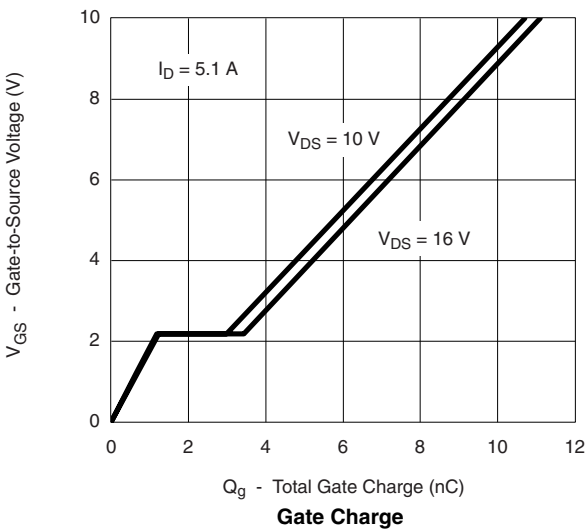

Gate Charge

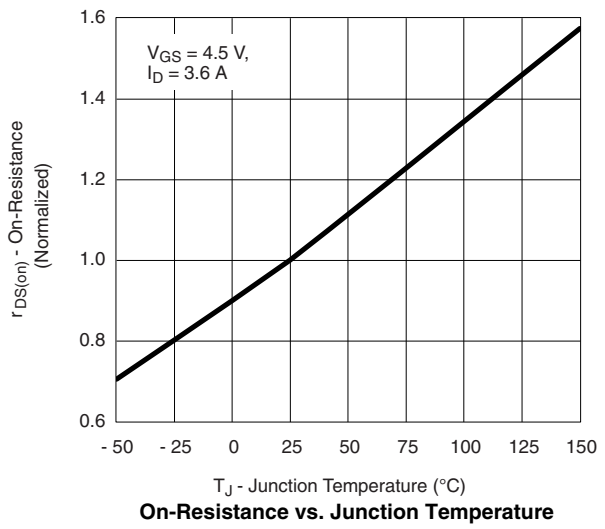

On-Resistance vs. Junction Temperature

MOSFET TYPICAL CHARACTERISTICS 25 °C, unless otherwise noted

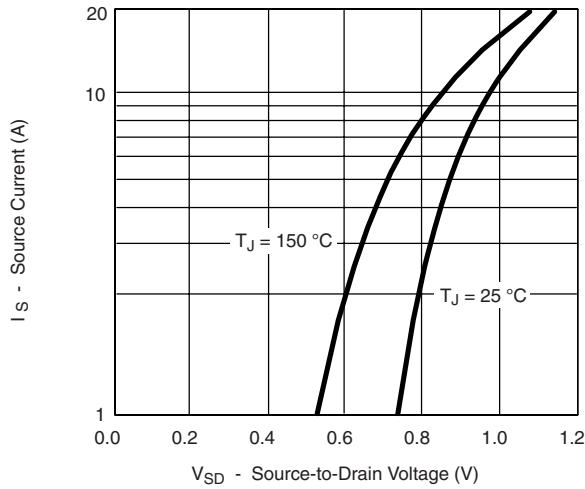

Source-Drain Diode Forward Voltage

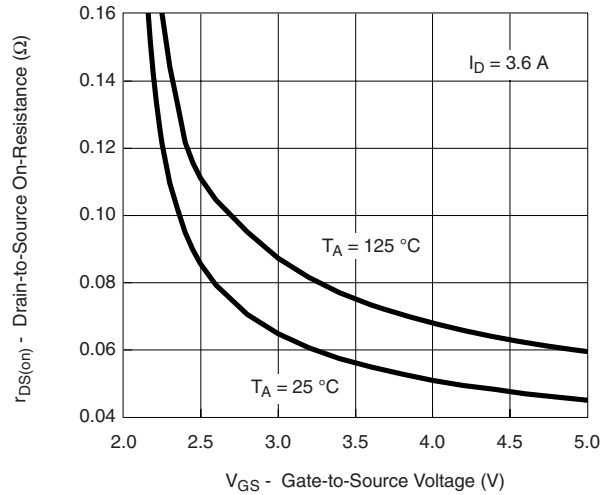

On-Resistance vs. Gate-to-Source Voltage

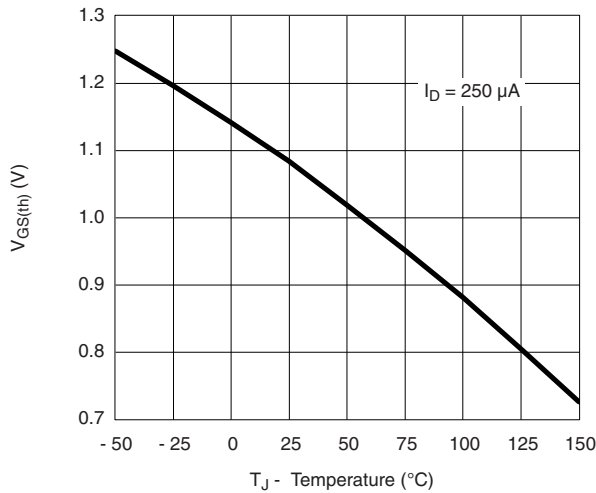

Threshold Voltage

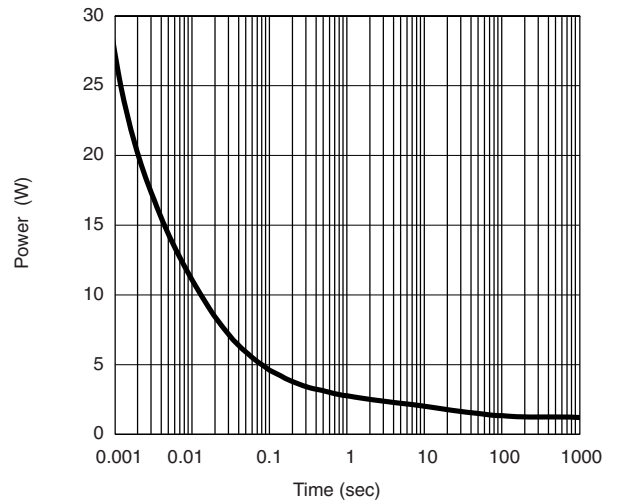

Single Pulse Power, Junction-to-Ambient

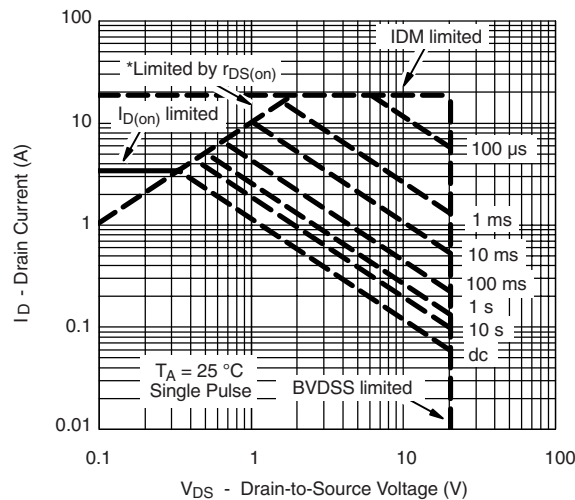

* $V_{GS} >$ minimum V_{GS} at which $r_{DS(on)}$ is specified

Safe Operating Area, Junction-to-Case

MOSFET TYPICAL CHARACTERISTICS 25 °C, unless otherwise noted

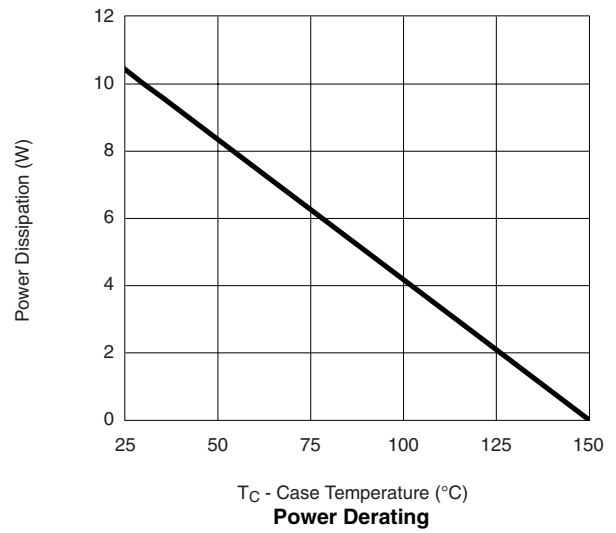
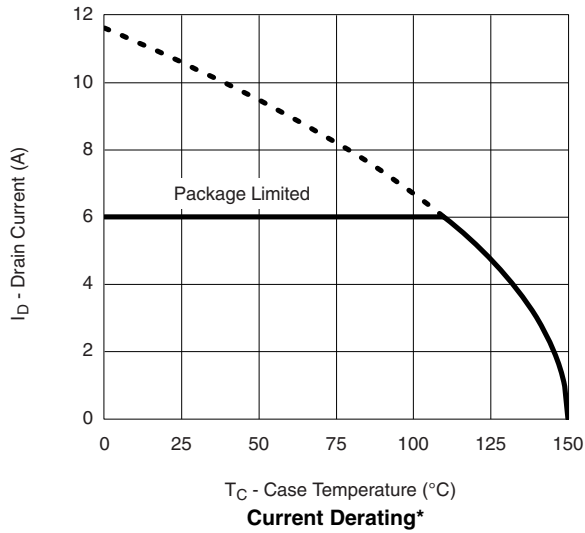

*The power dissipation P_D is based on $T_{J(max)} = 150$ °C, using junction-to-case thermal resistance, and is more useful in settling the upper dissipation limit for cases where additional heatsinking is used. It is used to determine the current rating, when this rating falls below the package limit.

MOSFET TYPICAL CHARACTERISTICS 25 °C, unless otherwise noted

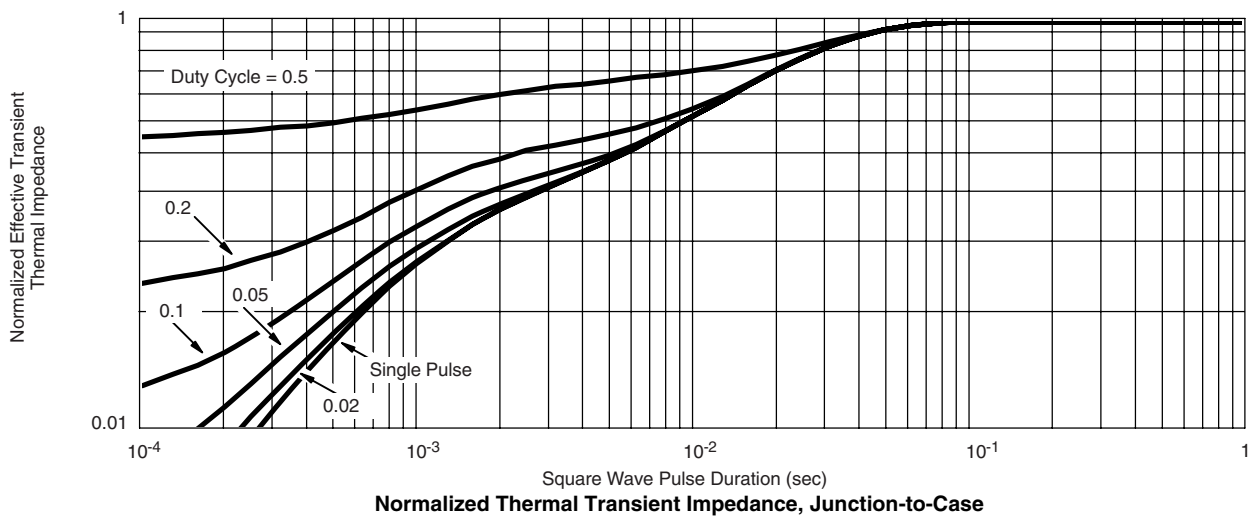
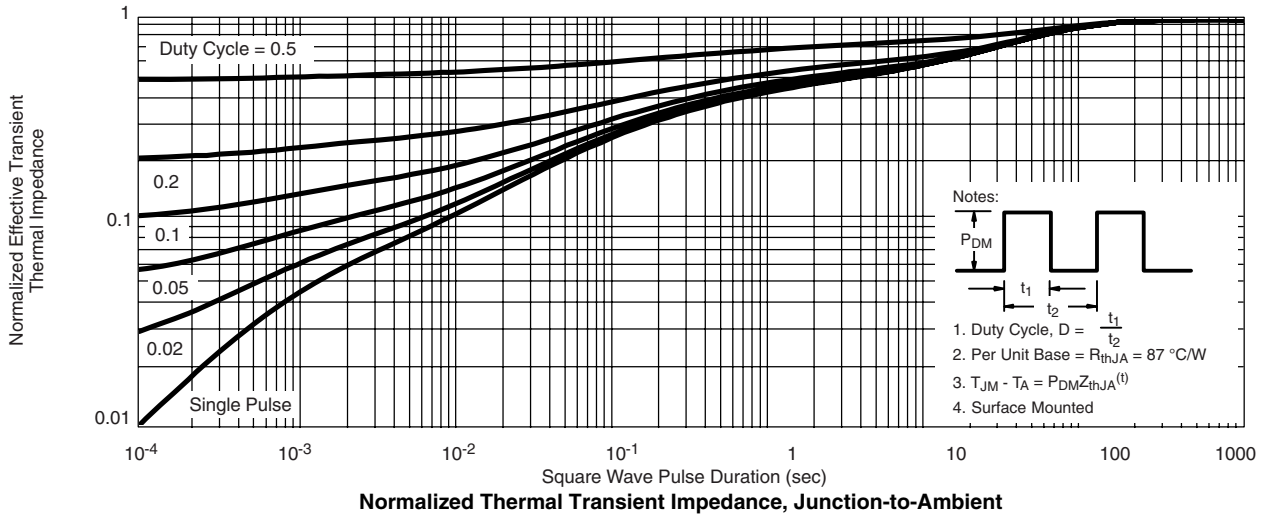

SCHOTTKY TYPICAL CHARACTERISTICS 25 °C, unless otherwise noted

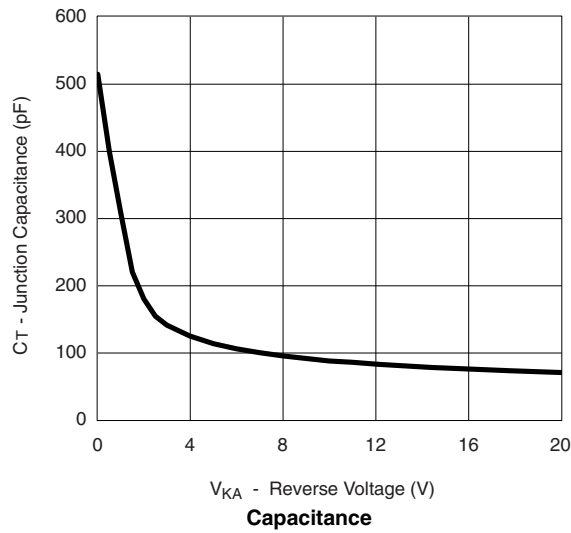
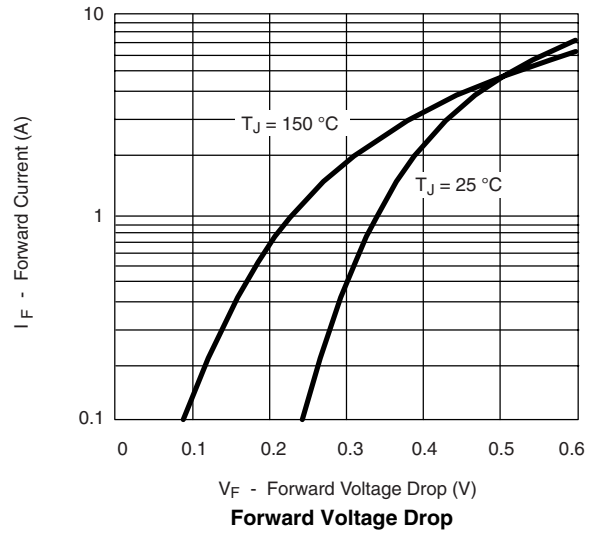
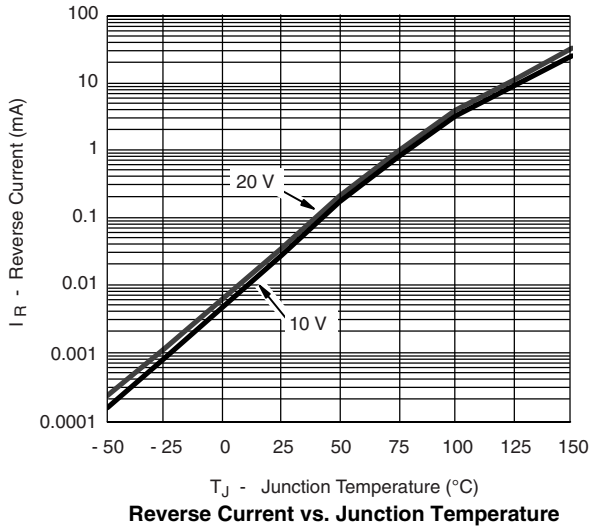

SCHOTTKY TYPICAL CHARACTERISTICS 25 °C, unless otherwise noted

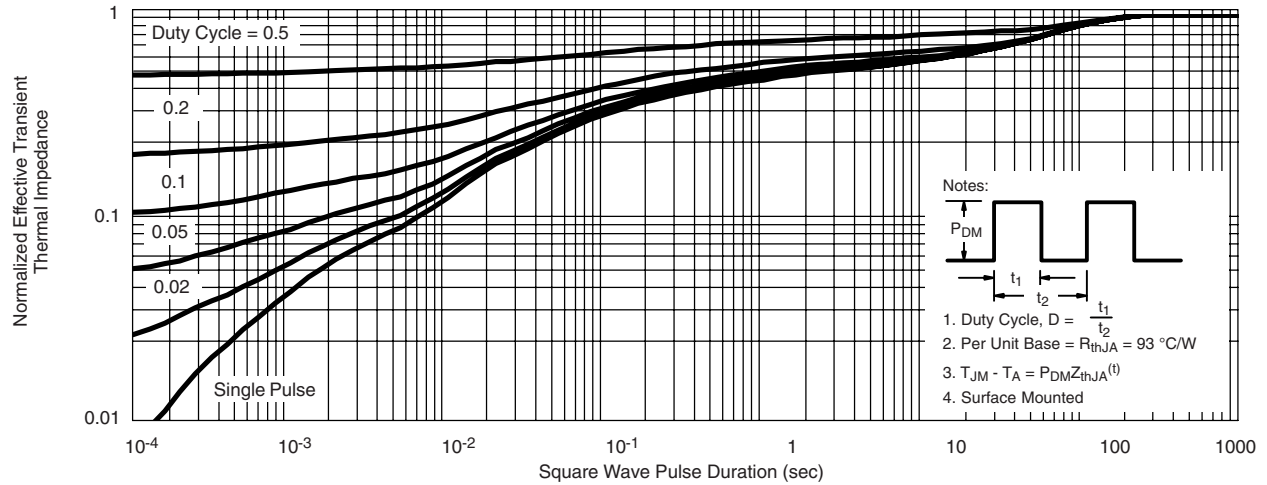

Normalized Thermal Transient Impedance, Junction-to-Ambient

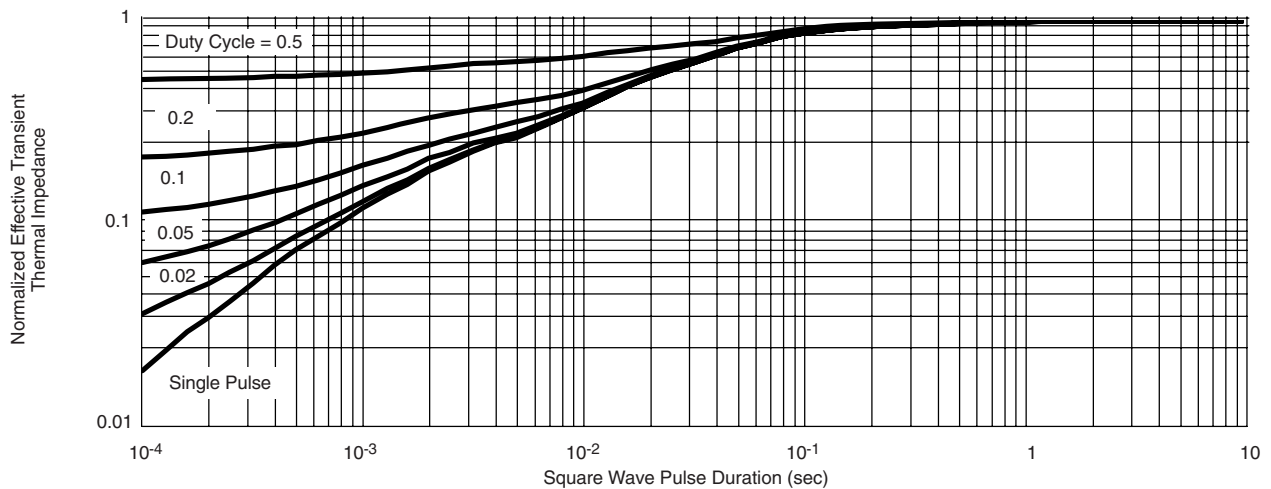

Normalized Thermal Transient Impedance, Junction-to-Case

Vishay Siliconix maintains worldwide manufacturing capability. Products may be manufactured at one of several qualified locations. Reliability data for Silicon Technology and Package Reliability represent a composite of all qualified locations. For related documents such as package/tape drawings, part marking, and reliability data, see <http://www.vishay.com/ppg?73696>.



Notice

Specifications of the products displayed herein are subject to change without notice. Vishay Intertechnology, Inc., or anyone on its behalf, assumes no responsibility or liability for any errors or inaccuracies.

Information contained herein is intended to provide a product description only. No license, express or implied, by estoppel or otherwise, to any intellectual property rights is granted by this document. Except as provided in Vishay's terms and conditions of sale for such products, Vishay assumes no liability whatsoever, and disclaims any express or implied warranty, relating to sale and/or use of Vishay products including liability or warranties relating to fitness for a particular purpose, merchantability, or infringement of any patent, copyright, or other intellectual property right.

The products shown herein are not designed for use in medical, life-saving, or life-sustaining applications. Customers using or selling these products for use in such applications do so at their own risk and agree to fully indemnify Vishay for any damages resulting from such improper use or sale.