

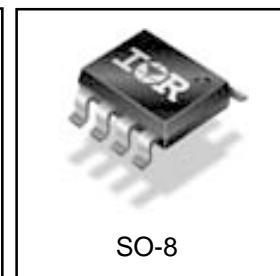
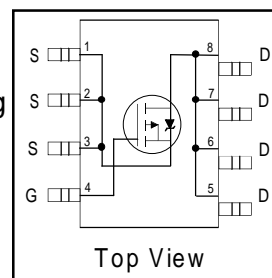
### Applications

- Reset Switch for Active Clamp Reset DC-DC converters

$V_{DSS}$	$R_{DS(on) \text{ max}}$	$I_D$
-150V	0.240Ω @ $V_{GS} = -10V$	-2.2A

### Benefits

- Low Gate to Drain Charge to Reduce Switching Losses
- Fully Characterized Capacitance Including Effective  $C_{OSS}$  to Simplify Design (See App. Note AN1001)
- Fully Characterized Avalanche Voltage and Current



### Absolute Maximum Ratings

	Parameter	Max.	Units
$I_D @ T_A = 25^\circ\text{C}$	Continuous Drain Current, $V_{GS} @ 10V$	-2.2	A
$I_D @ T_A = 70^\circ\text{C}$	Continuous Drain Current, $V_{GS} @ 10V$	-1.9	
$I_{DM}$	Pulsed Drain Current ①	-19	
$P_D @ T_A = 25^\circ\text{C}$	Power Dissipation④	2.5	W
	Linear Derating Factor	0.02	W/°C
$V_{GS}$	Gate-to-Source Voltage	± 20	V
dv/dt	Peak Diode Recovery dv/dt	7.8	V/ns
$T_J$	Operating Junction and	-55 to + 150	°C
$T_{STG}$	Storage Temperature Range		
	Soldering Temperature, for 10 seconds	300 (1.6mm from case )	

### Thermal Resistance

Symbol	Parameter	Typ.	Max.	Units
$R_{\theta JL}$	Junction-to-Drain Lead	—	20	°C/W
$R_{\theta JA}$	Junction-to-Ambient ④	—	50	

Notes ① through ④ are on page 8  
www.irf.com

# IRF6216

International  
**IR** Rectifier

## Static @ T<sub>J</sub> = 25°C (unless otherwise specified)

	Parameter	Min.	Typ.	Max.	Units	Conditions
V <sub>(BR)DSS</sub>	Drain-to-Source Breakdown Voltage	-150	—	—	V	V <sub>GS</sub> = 0V, I <sub>D</sub> = -250μA
ΔV <sub>(BR)DSS/ΔT<sub>J</sub></sub>	Breakdown Voltage Temp. Coefficient	—	-0.17	—	V/°C	Reference to 25°C, I <sub>D</sub> = -1mA ③
R <sub>DS(on)</sub>	Static Drain-to-Source On-Resistance	—	—	0.240	Ω	V <sub>GS</sub> = -10V, I <sub>D</sub> = -1.3A ③
V <sub>GS(th)</sub>	Gate Threshold Voltage	-3.0	—	-5.0	V	V <sub>DS</sub> = V <sub>GS</sub> , I <sub>D</sub> = -250μA
I <sub>DSS</sub>	Drain-to-Source Leakage Current	—	—	-25	μA	V <sub>DS</sub> = -150V, V <sub>GS</sub> = 0V
		—	—	-250		V <sub>DS</sub> = -120V, V <sub>GS</sub> = 0V, T <sub>J</sub> = 125°C
I <sub>GSS</sub>	Gate-to-Source Forward Leakage	—	—	-100	nA	V <sub>GS</sub> = -20V
	Gate-to-Source Reverse Leakage	—	—	100		V <sub>GS</sub> = 20V

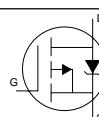
## Dynamic @ T<sub>J</sub> = 25°C (unless otherwise specified)

	Parameter	Min.	Typ.	Max.	Units	Conditions
g <sub>fs</sub>	Forward Transconductance	2.7	—	—	S	V <sub>DS</sub> = -50V, I <sub>D</sub> = -1.3A
Q <sub>g</sub>	Total Gate Charge	—	33	49	nC	I <sub>D</sub> = -1.3A
Q <sub>gs</sub>	Gate-to-Source Charge	—	7.2	11		V <sub>DS</sub> = -120V
Q <sub>gd</sub>	Gate-to-Drain ("Miller") Charge	—	15	23		V <sub>GS</sub> = -10V,
t <sub>d(on)</sub>	Turn-On Delay Time	—	18	—	ns	V <sub>DD</sub> = -75V
t <sub>r</sub>	Rise Time	—	15	—		I <sub>D</sub> = -1.3A
t <sub>d(off)</sub>	Turn-Off Delay Time	—	33	—		R <sub>G</sub> = 6.5Ω
t <sub>f</sub>	Fall Time	—	26	—		V <sub>GS</sub> = -10V ③
C <sub>iss</sub>	Input Capacitance	—	1280	—	pF	V <sub>GS</sub> = 0V
C <sub>oss</sub>	Output Capacitance	—	220	—		V <sub>DS</sub> = -25V
C <sub>riss</sub>	Reverse Transfer Capacitance	—	53	—		f = 1.0MHz
C <sub>oss</sub>	Output Capacitance	—	1290	—		V <sub>GS</sub> = 0V, V <sub>DS</sub> = -1.0V, f = 1.0MHz
C <sub>oss</sub>	Output Capacitance	—	99	—		V <sub>GS</sub> = 0V, V <sub>DS</sub> = -120V, f = 1.0MHz
C <sub>oss eff.</sub>	Effective Output Capacitance	—	220	—		V <sub>GS</sub> = 0V, V <sub>DS</sub> = 0V to -120V

## Avalanche Characteristics

	Parameter	Typ.	Max.	Units
E <sub>AS</sub>	Single Pulse Avalanche Energy②	—	200	mJ
I <sub>AR</sub>	Avalanche Current①	—	-4.0	A

## Diode Characteristics

	Parameter	Min.	Typ.	Max.	Units	Conditions
I <sub>S</sub>	Continuous Source Current (Body Diode)	—	—	-2.2	A	MOSFET symbol showing the integral reverse p-n junction diode. 
I <sub>SM</sub>	Pulsed Source Current (Body Diode) ①	—	—	-19		
V <sub>SD</sub>	Diode Forward Voltage	—	—	-1.6	V	T <sub>J</sub> = 25°C, I <sub>S</sub> = -1.3A, V <sub>GS</sub> = 0V ③
t <sub>rr</sub>	Reverse Recovery Time	—	80	120	nS	T <sub>J</sub> = 25°C, I <sub>F</sub> = -1.3A
Q <sub>rr</sub>	Reverse Recovery Charge	—	310	460	nC	di/dt = -100A/μs ③

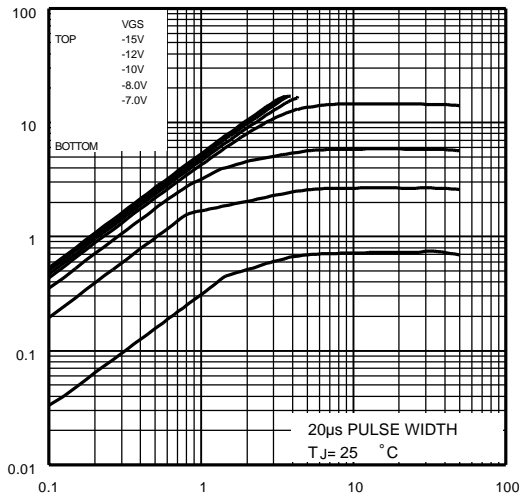


Fig 1. Typical Output Characteristics

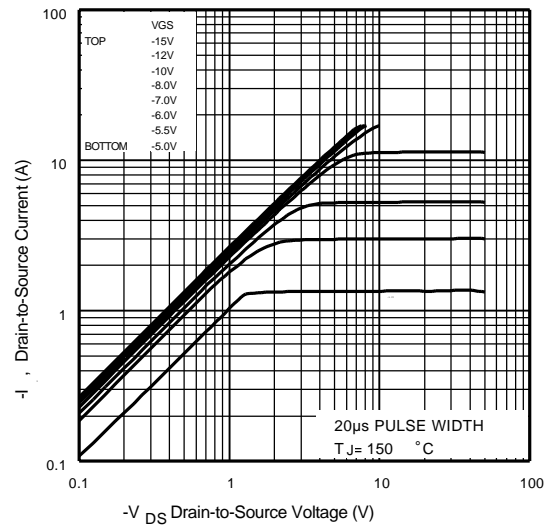


Fig 2. Typical Output Characteristics

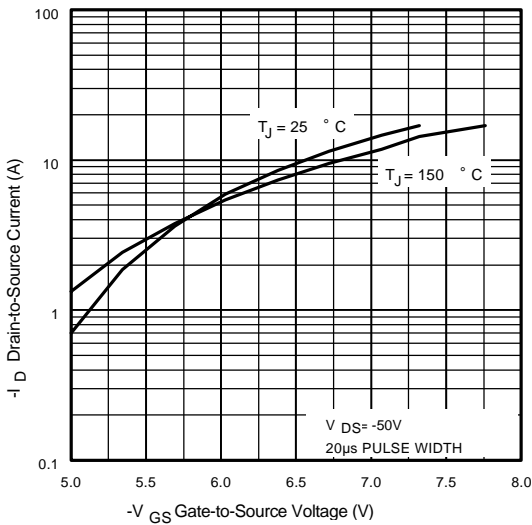


Fig 3. Typical Transfer Characteristics

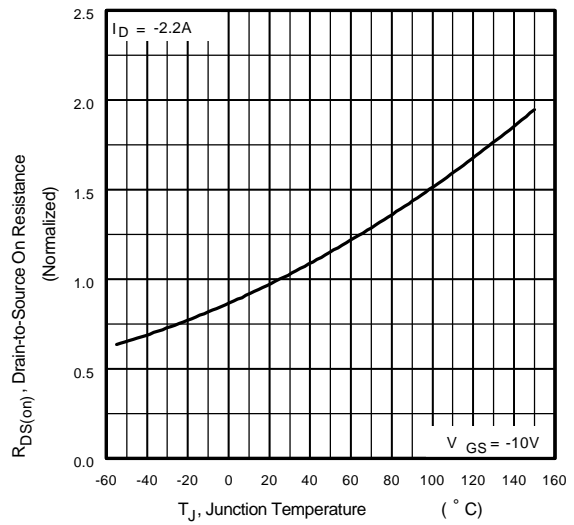
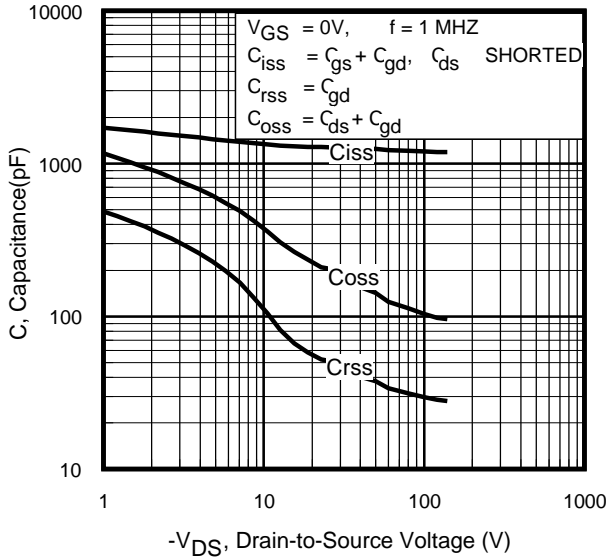
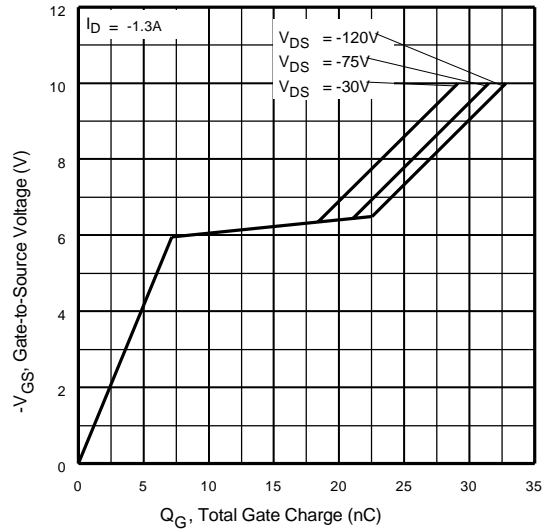


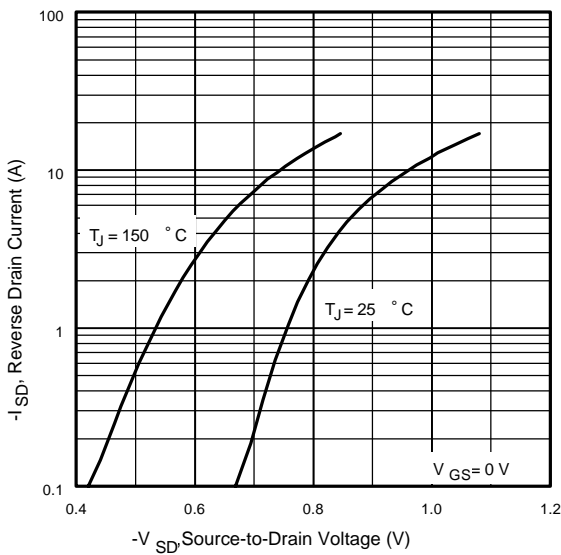
Fig 4. Normalized On-Resistance Vs. Temperature



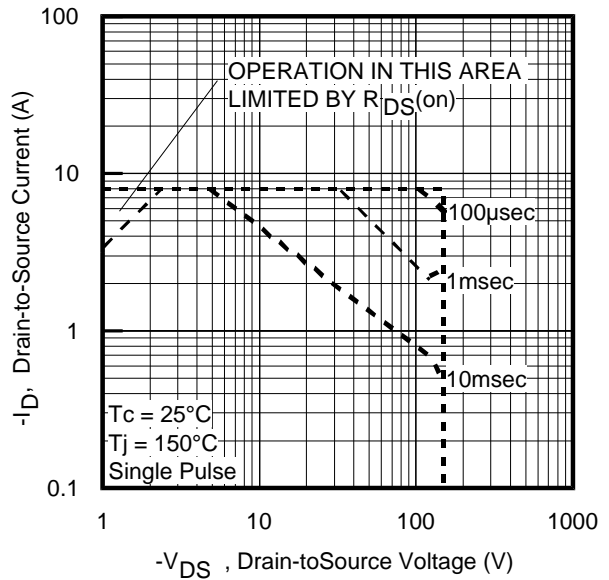
**Fig 5.** Typical Capacitance Vs. Drain-to-Source Voltage



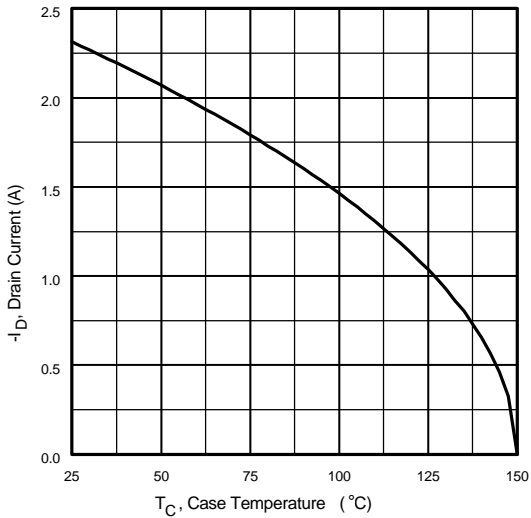
**Fig 6.** Typical Gate Charge Vs. Gate-to-Source Voltage



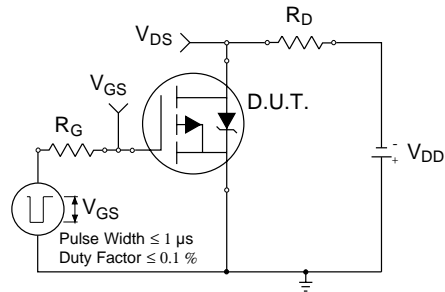
**Fig 7.** Typical Source-Drain Diode Forward Voltage



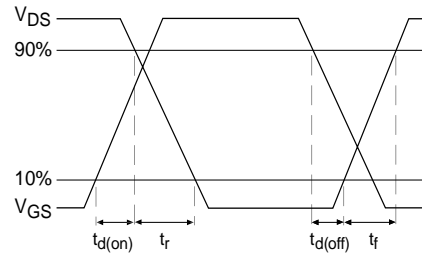
**Fig 8.** Maximum Safe Operating Area



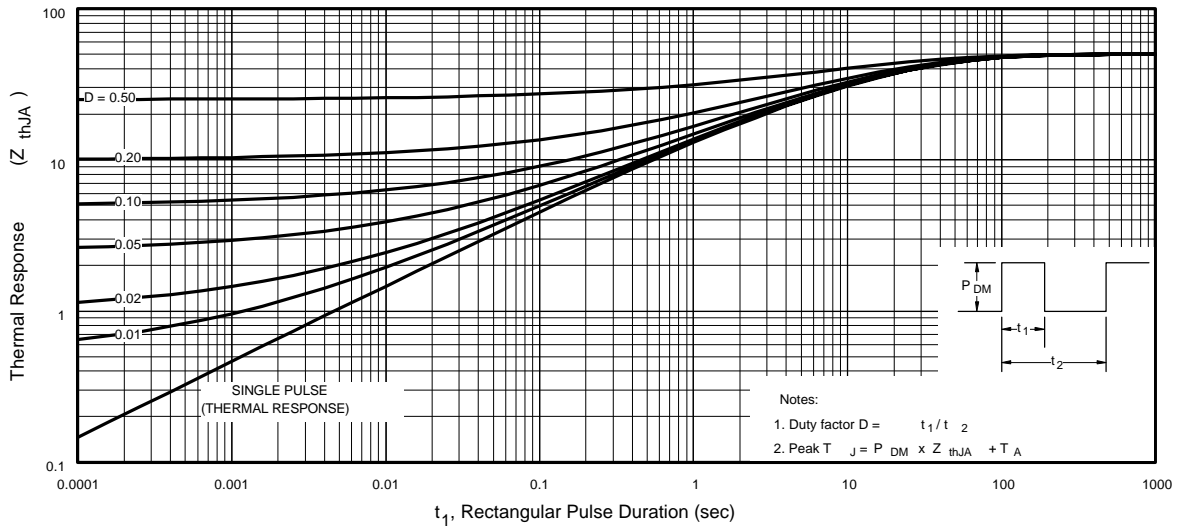
**Fig 9.** Maximum Drain Current Vs. Ambient Temperature



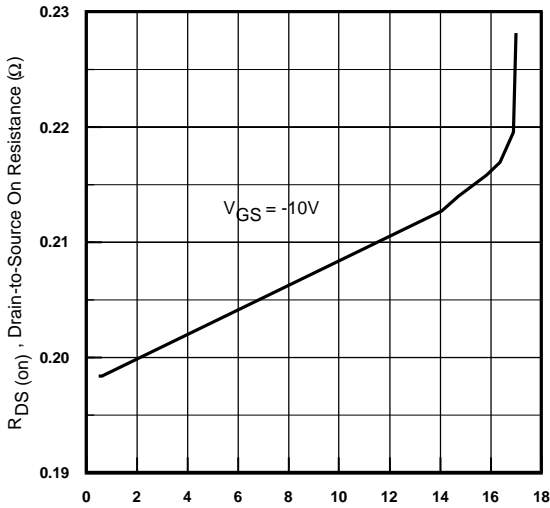
**Fig 10a.** Switching Time Test Circuit



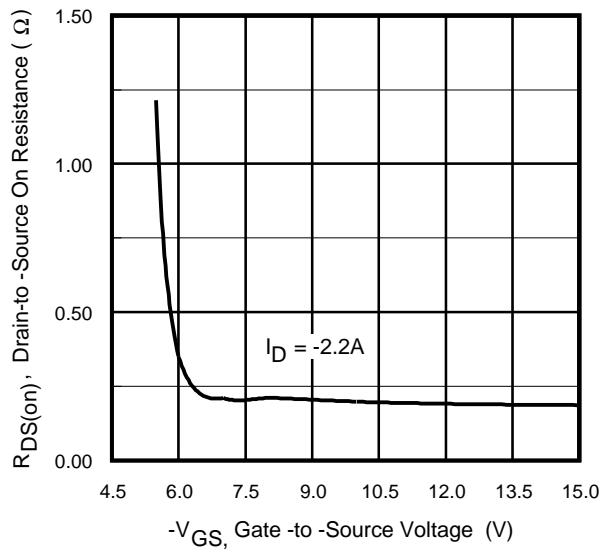
**Fig 10b.** Switching Time Waveforms



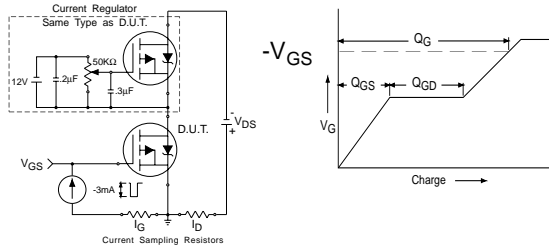
**Fig 11.** Maximum Effective Transient Thermal Impedance, Junction-to-Ambient



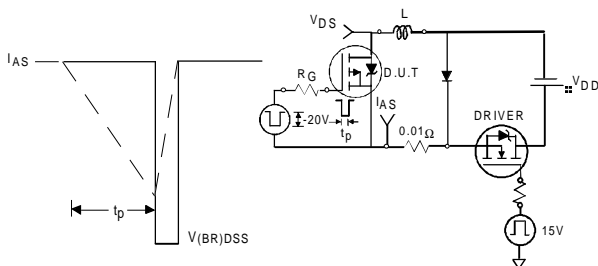
**Fig 12.** On-Resistance Vs. Drain Current



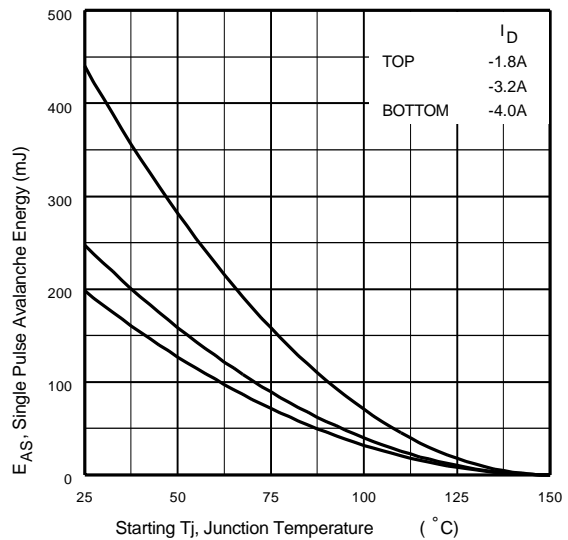
**Fig 13.** On-Resistance Vs. Gate Voltage



**Fig 14a&b.** Basic Gate Charge Test Circuit and Waveform

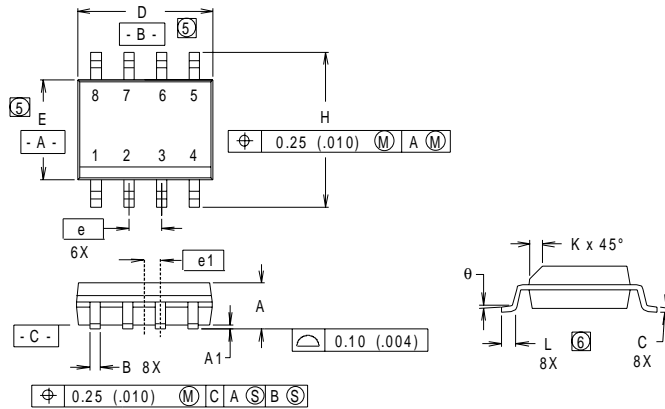


**Fig 15a&b.** Unclamped Inductive Test circuit and Waveforms



**Fig 15c.** Maximum Avalanche Energy Vs. Drain Current

## SO-8 Package Details



DIM	INCHES		MILLIMETERS	
	MIN	MAX	MIN	MAX
A	.0532	.0688	1.35	1.75
A1	.0040	.0098	0.10	0.25
B	.014	.018	0.36	0.46
C	.0075	.0098	0.19	0.25
D	.189	.196	4.80	4.98
E	.150	.157	3.81	3.99
e	.050 BASIC		1.27 BASIC	
e1	.025 BASIC		0.635 BASIC	
H	.2284	.2440	5.80	6.20
K	.011	.019	0.28	0.48
L	0.16	.050	0.41	1.27
θ	0°	8°	0°	8°

### RECOMMENDED FOOTPRINT

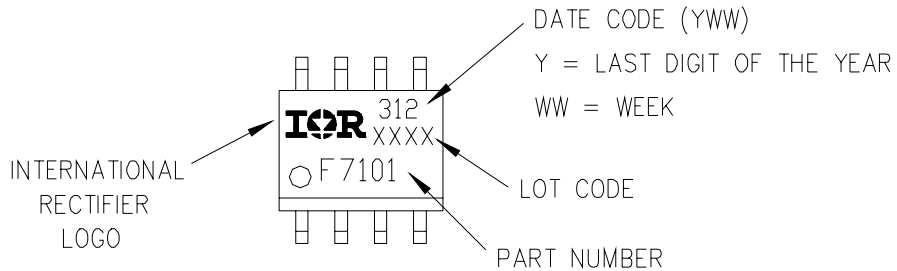


### NOTES:

1. DIMENSIONING AND TOLERANCING PER ANSI Y 14.5M-1982.
2. CONTROLLING DIMENSION : INCH.
3. DIMENSIONS ARE SHOWN IN MILLIMETERS (INCHES).
4. OUTLINE CONFORMS TO JEDEC OUTLINE MS-012AA.
- ⑤ DIMENSION DOES NOT INCLUDE MOLD PROTRUSIONS  
MOLD PROTRUSIONS NOT TO EXCEED 0.25 (.006).
- ⑥ DIMENSIONS IS THE LENGTH OF LEAD FOR SOLDERING TO A SUBSTRATE..

## SO-8 Part Marking

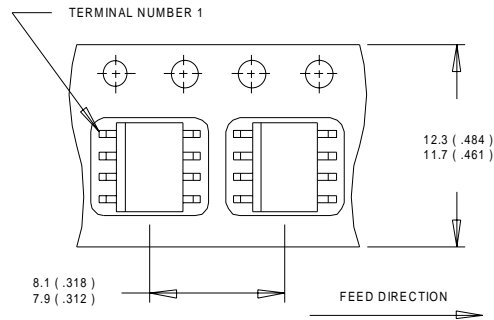
EXAMPLE: THIS IS AN IRF7101



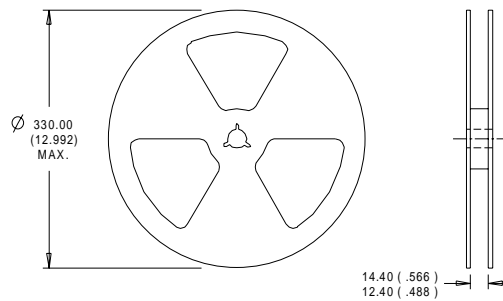
# IRF6216

International  
**IR** Rectifier

## SO-8 Tape and Reel



- NOTES:
1. CONTROLLING DIMENSION : MILLIMETER.
  2. ALL DIMENSIONS ARE SHOWN IN MILLIMETERS(INCHES).
  3. OUTLINE CONFORMS TO EIA-481 & EIA-541.



- NOTES :
1. CONTROLLING DIMENSION : MILLIMETER.
  2. OUTLINE CONFORMS TO EIA-481 & EIA-541.

### Notes:

- ① Repetitive rating; pulse width limited by max. junction temperature.
- ② Starting  $T_J = 25^\circ\text{C}$ ,  $L = 25\text{mH}$   
 $R_G = 25\Omega$ ,  $I_{AS} = -4.0\text{A}$ .
- ③ Pulse width  $\leq 400\mu\text{s}$ ; duty cycle  $\leq 2\%$ .
- ④ When mounted on 1 inch square copper board.

Data and specifications subject to change without notice.  
This product has been designed and qualified for the Industrial market.  
Qualification Standards can be found on IR's Web site.

International  
**IR** Rectifier

IR WORLD HEADQUARTERS: 233 Kansas St., El Segundo, California 90245, USA Tel: (310) 252-7105  
TAC Fax: (310) 252-7903

Visit us at [www.irf.com](http://www.irf.com) for sales contact information.02/02

[www.irf.com](http://www.irf.com)