

# ATV61HD11N4

variable speed drive ATV61 - 11kW 15HP -  
380...480V - IP20



## Main

Range of product	Altivar 61
Product or component type	Variable speed drive
Product specific application	Pumping and ventilation machine
Component name	ATV61
Motor power kW	11 kW 3 phases at 380...480 V
Motor power hp	15 hp 3 phases at 380...480 V
Power supply voltage	380...480 V (- 15...10 %)
Supply number of phases	3 phases
Line current	30 A for 480 V 3 phases 11 kW / 15 hp 36.6 A for 380 V 3 phases 11 kW / 15 hp
EMC filter	Level 3 EMC filter
Assembly style	With heat sink
Apparent power	24.1 kVA for 380 V 3 phases 11 kW / 15 hp
Maximum prospective line Isc	22 kA 3 phases
Maximum transient current	33.2 A for 60 s 3 phases
Nominal switching frequency	12 kHz
Switching frequency	1...16 kHz adjustable 12...16 kHz with derating factor
Asynchronous motor control	Voltage/Frequency ratio, 2 points Voltage/Frequency ratio, 5 points Flux vector control without sensor, standard Voltage/Frequency ratio - Energy Saving, quadratic U/f
Synchronous motor control profile	Vector control without sensor, standard
Communication port protocol	CANopen Modbus
Type of polarization	No impedance for Modbus
Option card	APOGEE FLN communication card BACnet communication card CC-Link communication card Controller inside programmable card DeviceNet communication card Ethernet/IP communication card Fipio communication card I/O extension card Interbus-S communication card LonWorks communication card METASYS N2 communication card Modbus Plus communication card Modbus TCP communication card Modbus/Uni-Telway communication card Multi-pump card Profibus DP communication card Profibus DP V1 communication card

The information provided in this documentation contains general descriptions and/or technical characteristics of the performance of the products contained herein. This documentation is not intended as a substitute for and is not to be used for determining suitability or reliability of these products for specific user applications. It is the duty of any such user or integrator to perform the appropriate and complete risk analysis, evaluation and testing of the products with respect to the relevant specific application or use thereof. Neither Schneider Electric Industries SAS nor any of its affiliates or subsidiaries shall be responsible or liable for misuse of the information contained herein.

## Complementary

Product destination	Asynchronous motors Synchronous motors
Power supply voltage limits	323...528 V
Power supply frequency	50...60 Hz (- 5...5 %)
Power supply frequency limits	47.5...63 Hz
Continuous output current	21 A at 12 kHz, 460 V 3 phases 27.7 A at 12 kHz, 380 V 3 phases
Speed drive output frequency	0.1...1000 Hz
Speed range	1...100 in open-loop mode, without speed feedback
Speed accuracy	+/- 10 % of nominal slip for 0.2 Tn to Tn torque variation without speed feedback
Torque accuracy	+/- 15 % in open-loop mode, without speed feedback
Transient overtorque	130 % of nominal motor torque, +/- 10 % for 60 s
Braking torque	<= 125 % with braking resistor 30 % without braking resistor
Regulation loop	Frequency PI regulator
Motor slip compensation	Adjustable Automatic whatever the load Can be suppressed Not available in voltage/frequency ratio (2 or 5 points)
Diagnostic	1 LED red presence of drive voltage
Output voltage	<= power supply voltage
Electrical isolation	Between power and control terminals
Type of cable for mounting in an enclosure	With an IP21 or an IP31 kit: 3-strand IEC cable at 40 °C, copper 70 °C PVC With UL Type 1 kit: 3-strand UL 508 cable at 40 °C, copper 75 °C PVC Without mounting kit: 1-strand IEC cable at 45 °C, copper 70 °C PVC Without mounting kit: 1-strand IEC cable at 45 °C, copper 90 °C XLPE/EPR
Electrical connection	AI1-/AI1+, AI2, AO1, R1A, R1B, R1C, R2A, R2B, LI1...LI6, PWR terminal 2.5 mm <sup>2</sup> / AWG 14 L1/R, L2/S, L3/T, U/T1, V/T2, W/T3, PC/-, PO, PA/+, PA, PB terminal 16 mm <sup>2</sup> / AWG 4
Tightening torque	AI1-/AI1+, AI2, AO1, R1A, R1B, R1C, R2A, R2B, LI1...LI6, PWR 0.6 N.m L1/R, L2/S, L3/T, U/T1, V/T2, W/T3, PC/-, PO, PA/+, PA, PB 3 N.m / 26.5 lb.in
Supply	External supply 24 V DC (19...30 V), 30 W Internal supply for reference potentiometer (1 to 10 kOhm) 10.5 V DC +/- 5 %, <= 10 mA for overload and short-circuit protection Internal supply 24 V DC (21...27 V), <= 200 mA for overload and short-circuit protection
Analogue input number	2
Analogue input type	AI1-/AI1+ bipolar differential voltage +/- 10 V DC, input voltage 24 V max, resolution 11 bits + sign AI2 software-configurable current 0...20 mA, impedance 242 Ohm, resolution 11 bits AI2 software-configurable voltage 0...10 V DC, input voltage 24 V max, impedance 30000 Ohm, resolution 11 bits
Sampling time	Analog input AI1-/AI1+ 2 ms, +/- 0.5 ms Analog input AI2 2 ms, +/- 0.5 ms Analog output AO1 2 ms, +/- 0.5 ms Discrete input LI1...LI5 2 ms, +/- 0.5 ms Discrete input LI6 (if configured as logic input) 2 ms, +/- 0.5 ms
Absolute accuracy precision	AI1-/AI1+ +/- 0.6 % for a temperature variation 60 °C AI2 +/- 0.6 % for a temperature variation 60 °C AO1 +/- 1 % for a temperature variation 60 °C
Linearity error	AI1-/AI1+ +/- 0.15 % of maximum value AI2 +/- 0.15 % of maximum value AO1 +/- 0.2 %
Analogue output number	1
Analogue output type	AO1 software-configurable current, analogue output range 0...20 mA, impedance 500 Ohm, resolution 10 bits AO1 software-configurable voltage, analogue output range 0...10 V DC, impedance 470 Ohm, resolution 10 bits AO1 software-configurable logic output 10 V, <= 20 mA
Discrete output number	2
Discrete output type	R1A, R1B, R1C configurable relay logic NO/NC, electrical durability 100000 cycles R2A, R2B configurable relay logic NO, electrical durability 100000 cycles

Maximum response time	<= 100 ms in STO (Safe Torque Off) R1A, R1B, R1C <= 7 ms, tolerance +/- 0.5 ms R2A, R2B <= 7 ms, tolerance +/- 0.5 ms
Minimum switching current	Configurable relay logic 3 mA at 24 V DC
Maximum switching current	R1, R2 on inductive load, 2 A at 250 V AC, cos phi = 0.4, L/R = 7 ms R1, R2 on inductive load, 2 A at 30 V DC, cos phi = 0.4, L/R = 7 ms R1, R2 on resistive load, 5 A at 250 V AC, cos phi = 1, L/R = 0 ms R1, R2 on resistive load, 5 A at 30 V DC, cos phi = 1, L/R = 0 ms
Discrete input number	7
Discrete input type	LI1...LI5 programmable 24 V DC, voltage limits <= 30 V, with level 1 PLC, impedance 3500 Ohm LI6 switch-configurable 24 V DC, voltage limits <= 30 V, with level 1 PLC, impedance 3500 Ohm LI6 switch-configurable PTC probe 0...6, impedance 1500 Ohm PWR safety input 24 V DC, voltage limits <= 30 V, impedance 1500 Ohm
Discrete input logic	LI1...LI5 negative logic (sink), > 16 V (state 0), < 10 V (state 1) LI1...LI5 positive logic (source), < 5 V (state 0), > 11 V (state 1) LI6 (if configured as logic input)negative logic (sink), > 16 V (state 0), < 10 V (state 1) LI6 (if configured as logic input)positive logic (source), < 5 V (state 0), > 11 V (state 1)
Acceleration and deceleration ramps	Automatic adaptation of ramp if braking capacity exceeded, by using resistor Linear adjustable separately from 0.01 to 9000 s S, U or customized
Braking to standstill	By DC injection
Protection type	Drive against exceeding limit speed Drive against input phase loss Drive break on the control circuit Drive input phase breaks Drive line supply overvoltage Drive line supply undervoltage Drive overcurrent between output phases and earth Drive overheating protection Drive overvoltages on the DC bus Drive power removal Drive short-circuit between motor phases Drive thermal protection Motor motor phase break Motor power removal Motor thermal protection
Insulation resistance	> 1 MOhm at 500 V DC for 1 minute to earth
Frequency resolution	Analog input 0.024/50 Hz Display unit 0.1 Hz
Type of connector	1 RJ45 for Modbus on front face 1 RJ45 for Modbus on terminal Male SUB-D 9 on RJ45 for CANopen
Physical interface	2-wire RS 485 for Modbus
Transmission frame	RTU for Modbus
Transmission rate	20 kbps, 50 kbps, 125 kbps, 250 kbps, 500 kbps, 1 Mbps for CANopen 4800 bps, 9600 bps, 19200 bps, 38.4 Kbps for Modbus on terminal 9600 bps, 19200 bps for Modbus on front face
Data format	8 bits, 1 stop, even parity for Modbus on front face 8 bits, odd even or no configurable parity for Modbus on terminal
Number of addresses	1...127 for CANopen 1...247 for Modbus
Method of access	Slave for CANopen
Marking	CE
Operating position	Vertical +/- 10 degree
Product weight	7 kg
Width	210 mm
Height	295 mm
Depth	213 mm

## Environment

Noise level	57.4 dB conforming to 86/188/EEC
Dielectric strength	3535 V DC between earth and power terminals 5092 V DC between control and power terminals
Electromagnetic compatibility	Conducted radio-frequency immunity test conforming to IEC 61000-4-6 level 3 Electrical fast transient/burst immunity test conforming to IEC 61000-4-4 level 4 Electrostatic discharge immunity test conforming to IEC 61000-4-2 level 3 Radiated radio-frequency electromagnetic field immunity test conforming to IEC 61000-4-3 level 3 Voltage dips and interruptions immunity test conforming to IEC 61000-4-11
Standards	EN 55011 class A group 2 EN 61800-3 environments 1 category C3 EN 61800-3 environments 2 category C3 EN/IEC 61800-3 EN/IEC 61800-5-1 IEC 60721-3-3 class 3C1 IEC 60721-3-3 class 3S2 UL Type 1
Product certifications	CSA C-Tick DNV GOST NOM 117 UL
Pollution degree	2 conforming to EN/IEC 61800-5-1
Degree of protection	IP20 on upper part without blanking plate on cover conforming to EN/IEC 60529 IP20 on upper part without blanking plate on cover conforming to EN/IEC 61800-5-1 IP21 conforming to EN/IEC 60529 IP21 conforming to EN/IEC 61800-5-1 IP41 on upper part conforming to EN/IEC 60529 IP41 on upper part conforming to EN/IEC 61800-5-1 IP54 on lower part conforming to EN/IEC 60529 IP54 on lower part conforming to EN/IEC 61800-5-1
Vibration resistance	1 gn (f = 13...200 Hz) conforming to EN/IEC 60068-2-6 1.5 mm peak to peak (f = 3...13 Hz) conforming to EN/IEC 60068-2-6
Shock resistance	15 gn for 11 ms conforming to EN/IEC 60068-2-27
Relative humidity	5...95 % without condensation conforming to IEC 60068-2-3 5...95 % without dripping water conforming to IEC 60068-2-3
Ambient air temperature for operation	-10...50 °C without derating 50...60 °C with derating factor
Ambient air temperature for storage	-25...70 °C
Operating altitude	<= 1000 m without derating 1000...3000 m with current derating 1 % per 100 m
RoHS EUR status	Compliant
RoHS EUR conformity date	1027

UL Type 1/IP 20 Drives

Dimensions without Option Card

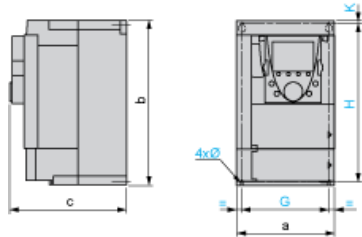

Dimensions in mm

a	b	c	G	H	K	Ø
210	295	213	190	283	6	6

Dimensions in in.

a	b	c	G	H	K	Ø
8.26	11.61	8.38	7.48	11.14	0.23	0.23

Dimensions with 1 Option Card (1)

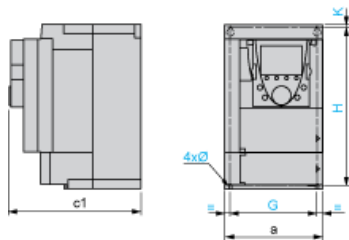

Dimensions in mm

a	c1	G	H	K	Ø
210	236	190	283	6	6

Dimensions in in.

a	c1	G	H	K	Ø
8.26	9.29	7.48	11.14	0.23	0.23

(1) Option cards: I/O extension cards, communication cards or "Controller Inside" programmable card.

Dimensions with 2 Option Cards (1)

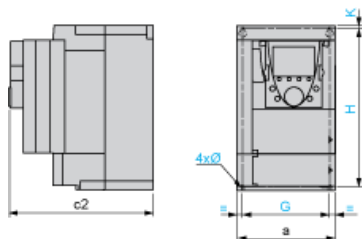

Dimensions in mm

a	c2	G	H	K	Ø
210	259	190	283	6	6

Dimensions in in.

a	c2	G	H	K	Ø
8.26	10.20	7.48	11.14	0.23	0.23

(1) Option cards: I/O extension cards, communication cards or "Controller Inside" programmable card.

## Mounting Recommendations

Depending on the conditions in which the drive is to be used, its installation will require certain precautions and the use of appropriate accessories.

Install the unit vertically:

- Avoid placing it close to heating elements
- Leave sufficient free space to ensure that the air required for cooling purposes can circulate from the bottom to the top of the unit.

### Clearance

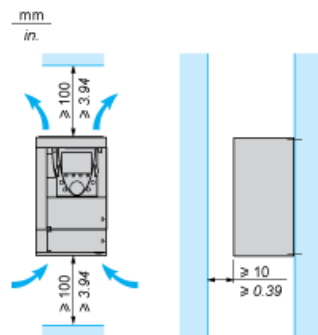

### Mounting Types

#### Type A Mounting

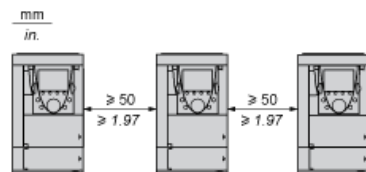

#### Type B Mounting

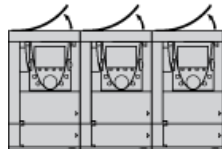

#### Type C Mounting

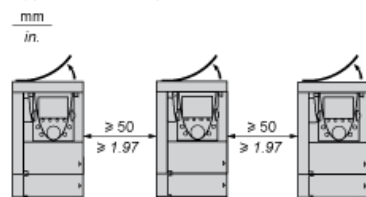

By removing the protective blanking cover from the top of the drive, the degree of protection for the drive becomes IP 20. The protective blanking cover may vary according to the drive model (refer to the user guide).

## Specific Recommendations for Mounting the Drive in an Enclosure

### Ventilation

To ensure proper air circulation in the drive:

- Fit ventilation grilles.
- Ensure that there is sufficient ventilation. If there is not, install a forced ventilation unit with a filter. The openings and/or fans must provide a flow rate at least equal to that of the drive fans (refer to the product characteristics).

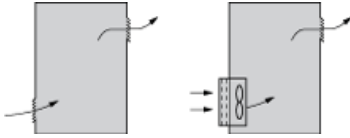

- Use special filters with IP 54 protection.
- Remove the blanking cover from the top of the drive.

### Dust and Damp Proof Metal Enclosure (IP 54)

The drive must be mounted in a dust and damp proof enclosure in certain environmental conditions: dust, corrosive gases, high humidity with risk of condensation and dripping water, splashing liquid, etc.

This enables the drive to be used in an enclosure where the maximum internal temperature reaches 50°C.



Wiring Diagram Conforming to Standards EN 954-1 Category 1, IEC/EN 61508 Capacity SIL1, in Stopping Category 0 According to IEC/EN 60204-1

Three-Phase Power Supply with Upstream Breaking via Contactor

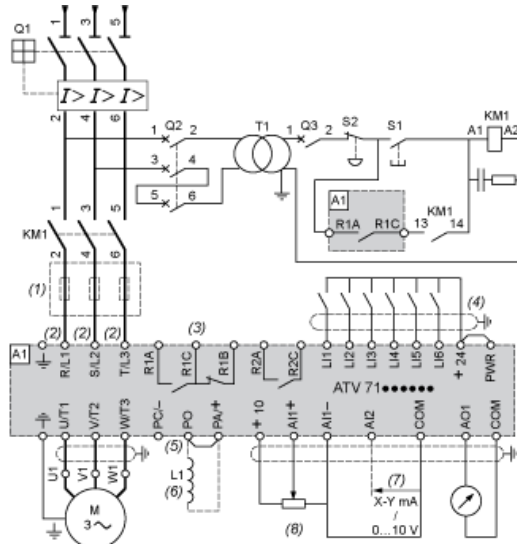

- A1 ATV61 drive
- KM1 Contactor
- L1 DC choke
- Q1 Circuit-breaker
- Q2 GV2 L rated at twice the nominal primary current of T1
- Q3 GB2CB05
- S1, XB4 B or XB5 A pushbuttons
- S2
- T1 100 VA transformer 220 V secondary
- (1) Line choke (three-phase); mandatory for ATV61HC11Y...HC80Y drives (except when a special transformer is used (12-pulse)).
- (2) For ATV61HC50N4, ATV61HC63N4 and ATV61HC50Y...HC80Y drives, refer to the power terminal connections diagram.
- (3) Fault relay contacts. Used for remote signalling of the drive status.
- (4) Connection of the common for the logic inputs depends on the positioning of the SW1 switch. The above diagram shows the internal power supply switched to the "source" position (for other connection types, refer to the user guide).
- (5) There is no PO terminal on ATV61HC11Y...HC80Y drives.
- (6) Optional DC choke for ATV61H...M3, ATV61HD11M3X...HD45M3X and ATV61H075N4...HD75N4 drives. Connected in place of the strap between the PO and PA/+ terminals. For ATV61HD55M3X...HD90M3X, ATV61HD90N4...HC63N4 drives, the choke is supplied with the drive; the customer is responsible for connecting it. For ATV61W...N4 and ATV61W...N4C drives, the DC choke is integrated.
- (7) Software-configurable current (0...20 mA) or voltage (0...10 V) analog input.
- (8) Reference potentiometer.

All terminals are located at the bottom of the drive. Fit interference suppressors on all inductive circuits near the drive or connected on the same circuit, such as relays, contactors, solenoid valves, fluorescent lighting, etc.

Wiring Diagram Conforming to Standards EN 954-1 Category 1, IEC/EN 61508 Capacity SIL1, in Stopping Category 0 According to IEC/EN 60204-1

## Three-Phase Power Supply with Downstream Breaking via Switch Disconnecter

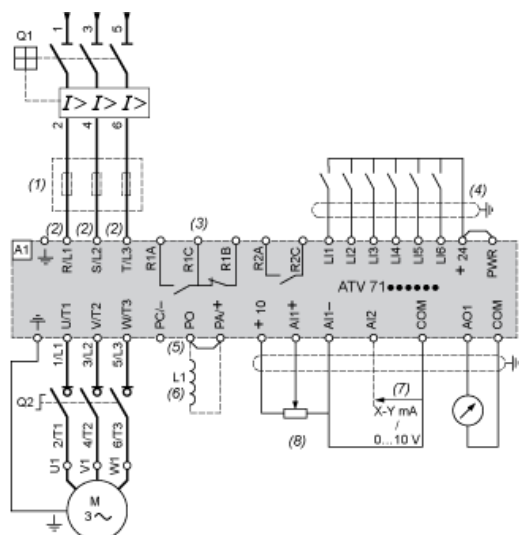

A1 ATV61 drive

L1 DC choke

Q1 Circuit-breaker

Q2 Switch disconnecter (Vario)

(1) Line choke (three-phase), mandatory for ATV61HC11Y...HC80Y drives (except when a special transformer is used (12-pulse)).

(2) For ATV61HC50N4, ATV61HC63N4 and ATV61HC50Y...HC80Y drives, refer to the power terminal connections diagram.

(3) Fault relay contacts. Used for remote signalling of the drive status.

(4) Connection of the common for the logic inputs depends on the positioning of the SW1 switch. The above diagram shows the internal power supply switched to the "source" position (for other connection types, refer to the user guide).

(5) There is no PO terminal on ATV61HC11Y...HC80Y drives.

(6) Optional DC choke for ATV61H...M3, ATV61HD11M3X...HD45M3X and ATV61H075N4...HD75N4 drives. Connected in place of the strap between the PO and PA/+ terminals. For ATV61HD55M3X...HD90M3X, ATV61HD90N4...HC63N4 drives, the choke is supplied with the drive; the customer is responsible for connecting it. For ATV61W...N4 and ATV61W...N4C drives, the DC choke is integrated.

(7) Software-configurable current (0...20 mA) or voltage (0...10 V) analog input.

(8) Reference potentiometer.

All terminals are located at the bottom of the drive. Fit interference suppressors on all inductive circuits near the drive or connected on the same circuit, such as relays, contactors, solenoid valves, fluorescent lighting, etc.

Wiring Diagram Conforming to Standards EN 954-1 Category 3, IEC/EN 61508 Capacity SIL2, in Stopping Category 0 According to IEC/EN 60204-1

### Three-Phase Power Supply, Low Inertia Machine, Vertical Movement

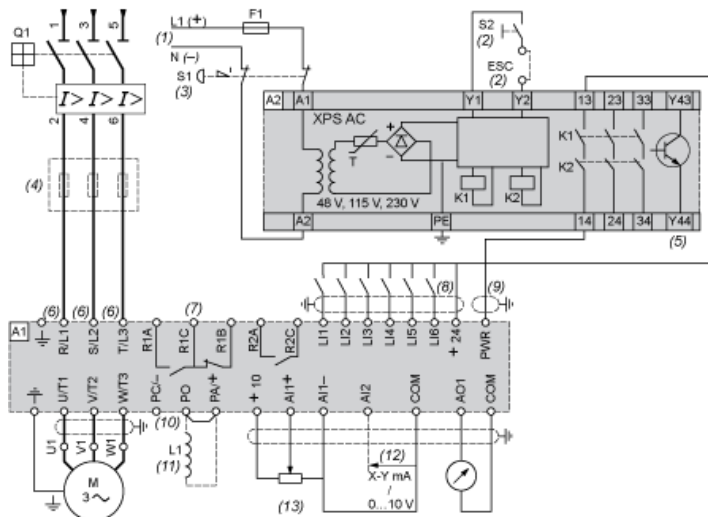

- A1 ATV61 drive
- A2 Preventa XPS AC safety module for monitoring emergency stops and switches. One safety module can manage the "Power Removal" function for several drives on the same machine. In this case, each drive must connect its PWR terminal to its + 24 V via the safety contacts on the XPS AC module. These contacts are independent for each drive.
- F1 Fuse
- L1 DC choke
- Q1 Circuit-breaker
- S1 Emergency stop button with 2 contacts
- S2 XB4 B or XB5 A pushbutton
- (1) Power supply: 24 Vdc or Vac, 115 Vac, 230 Vac.
- (2) S2: resets XPS AC module on power-up or after an emergency stop. ESC can be used to set external starting conditions.
- (3) Requests freewheel stopping of the movement and activates the "Power Removal" safety function.
- (4) Line choke (three-phase), mandatory for and ATV61HC11Y...HC80Y drives (except when a special transformer is used (12-pulse)).
- (5) The logic output can be used to signal that the machine is in a safe stop state.
- (6) For ATV61HC50N4, ATV61HC63N4 and ATV61HC50Y...HC80Y drives, refer to the power terminal connections diagram.
- (7) Fault relay contacts. Used for remote signalling of the drive status.
- (8) Connection of the common for the logic inputs depends on the positioning of the SW1 switch. The above diagram shows the internal power supply switched to the "source" position (for other connection types, refer to the user guide).
- (9) Standardized coaxial cable, type RG174/U according to MIL-C17 or KX3B according to NF C 93-550, external diameter 2.54 mm / 0.09 in., maximum length 15 m / 49.21 ft. The cable shielding must be earthed.
- (10) There is no PO terminal on ATV61HC11Y...HC80Y drives.
- (11) Optional DC choke for ATV61H...M3, ATV61HD11M3X...HD45M3X and ATV61H075N4...HD75N4 drives. Connected in place of the strap between the PO and PA/+ terminals. For ATV61HD55M3X...HD90M3X, ATV61HD90N4...HC63N4 drives, the choke is supplied with the drive; the customer is responsible for connecting it. For ATV61W...N4 and ATV61W...N4C drives, the DC choke is integrated.
- (12) Software-configurable current (0...20 mA) or voltage (0...10 V) analog input.
- (13) Reference potentiometer.

All terminals are located at the bottom of the drive. Fit interference suppressors on all inductive circuits near the drive or connected on the same circuit, such as relays, contactors, solenoid valves, fluorescent lighting, etc.

Wiring Diagram Conforming to Standards EN 954-1 Category 3, IEC/EN 61508 Capacity SIL2, in Stopping Category 1 According to IEC/EN 60204-1

### Three-Phase Power Supply, High Inertia Machine

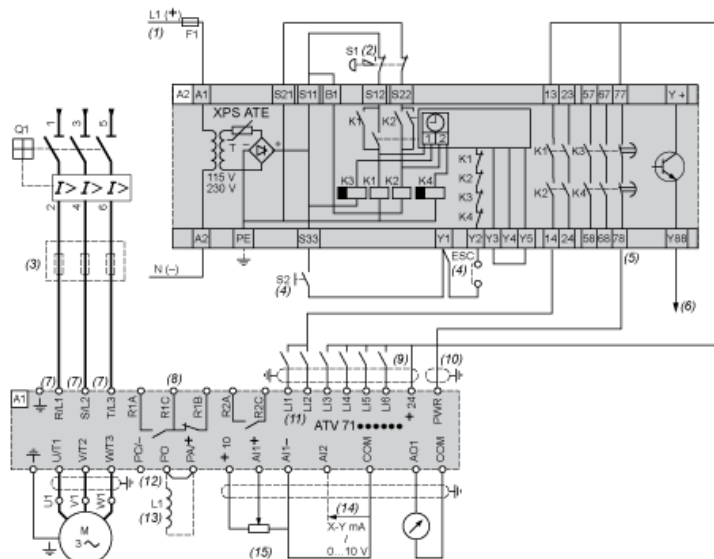

- A1 ATV61 drive
- A2 Preventa XPS ATE safety module for monitoring emergency stops and switches. One safety module can manage the "Power Removal" safety function for several drives on the same machine. In this case the time delay must be adjusted on the drive controlling the motor that requires the longest stopping time. In addition, each drive must connect its PWR terminal to its + 24 V via the safety contacts on the XPS ATE module. These contacts are independent for each drive.
- (5) safety function for several drives on the same machine. In this case the time delay must be adjusted on the drive controlling the motor that requires the longest stopping time. In addition, each drive must connect its PWR terminal to its + 24 V via the safety contacts on the XPS ATE module. These contacts are independent for each drive.
- F1 Fuse
- L1 DC choke
- Q1 Circuit-breaker
- S1 Emergency stop button with 2 contacts
- S2 XB4 B or XB5 A pushbutton
- (1) Power supply: 24 Vdc or Vac, 115 Vac, 230 Vac.
- (2) Requests controlled stopping of the movement and activates the "Power Removal" safety function.
- (3) Line choke (three-phase), mandatory for ATV61HC11Y...HC80Y drives (except when a special transformer is used (12-pulse)).
- (4) S2: resets XPS ATE module on power-up or after an emergency stop. ESC can be used to set external starting conditions.
- (5) The logic output can be used to signal that the machine is in a safe state.
- (6) For stopping times requiring more than 30 seconds in category 1, use a Preventa XPS AV safety module which can provide a maximum time delay of 300 seconds.
- (7) For ATV61HC50N4, ATV61HC63N4 and ATV61HC50Y...HC80Y drives, refer to the power terminal connections diagram.
- (8) Fault relay contacts. Used for remote signalling of the drive status.
- (9) Connection of the common for the logic inputs depends on the positioning of the SW1 switch. The above diagram shows the internal power supply switched to the "source" position (for other connection types, refer to the user guide).
- (10) Standardized coaxial cable, type RG174/U according to MIL-C17 or KX3B according to NF C 93-550, external diameter 2.54 mm/0.09 in., maximum length 15 m/49.21 ft. The cable shielding must be earthed.
- (11) Logic inputs LI1 and LI2 must be assigned to the direction of rotation: LI1 in the forward direction and LI2 in the reverse direction.
- (12) There is no PO terminal on ATV61HC11Y...HC80Y drives.
- (13) Optional DC choke for ATV61H...M3, ATV61HD11M3X...HD45M3X and ATV61H075N4...HD75N4 drives. Connected in place of the strap between the PO and PA/+ terminals. For ATV61HD55M3X...HD90M3X, ATV61HD90N4...HC63N4 drives, the choke is supplied with the drive; the customer is responsible for connecting it. For ATV61W...N4 and ATV61W...N4C drives, the DC choke is integrated.
- (14) Software-configurable current (0...20 mA) or voltage (0...10 V) analog input.
- (15) Reference potentiometer.

All terminals are located at the bottom of the drive. Fit interference suppressors on all inductive circuits near the drive or connected on the same circuit, such as relays, contactors, solenoid valves, fluorescent lighting, etc.

Derating Curves

The derating curves for the drive nominal current (In) depend on the temperature, the switching frequency and the mounting type (A, B or C). For intermediate temperatures (e.g. 55°C), interpolate between 2 curves.

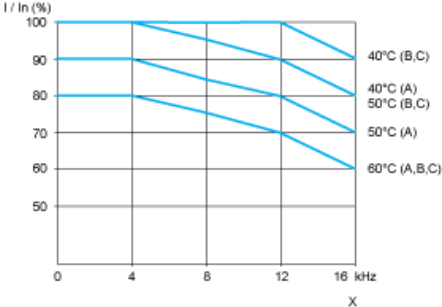

X Switching frequency