



Main

Range of product	Phaseo
Product or component type	Battery control module
Input voltage	24...28.8 V DC
Output voltage	(U _{battery} -0.5) V in battery mode DC (U _{in} -0.25) V in nominal mode DC
Maximum output current	20 A

Complementary

Input voltage limits	22...30 V
Current consumption	<= 40.6 A 0.1 mA , no load 0.6 A , on load
Power dissipation in W	< 7 W
Activation threshold	Adjustable 22...36 V
Number of output channels	1
Residual ripple	<= 200 mV
Output protection type	Against overload , protection technology: 1.5 x I _n Against short-circuits , protection technology: battery-backed mode, automatic re-set Against short-circuits , protection technology: power-supplied mode
Connections - terminals	Removable screw terminal block for diagnostic relay , connection capacity: 1 x 0.75 mm ² Screw type terminals for input connection , connection capacity: 2 x 0.5...2 x 10 mm ² AWG gauge20...8 Screw type terminals for output connection , connection capacity: 2 x 0.5...2 x 10 mm ² AWG gauge20...8
Fixing mode	By clips on 35 mm symmetrical DIN rail , operating position: horizontal By clips on 35 mm symmetrical DIN rail , operating position: vertical
Name of test	Electrostatic discharges conforming to EN/IEC 61000-4-2 Emission conforming to EN 61000-6-3 Induced electromagnetic field conforming to EN/IEC 61000-4-6 level 3 Radiated electromagnetic field conforming to EN/IEC 61000-4-3 level 3 Rapid transient conforming to IEC 61000-4-4 level 3 Surge conforming to EN/IEC 61000-4-5 level 2 Conducted/Radiated emissions conforming to EN 55022 Class B , 20 % derating factor
Local signalling	1 C/O relay , function: alarm status 1 C/O relay , function: battery status 1 C/O relay , function: power supply status LCD screen , function: module status
Product weight	0.5 kg

Environment

IP degree of protection	IP10 conforming to EN/IEC 60529
Ambient air temperature for operation	-25...60 °C
Ambient air temperature for storage	-40...85 °C
Relative humidity	0...90 % during operation 0...95 % during storage
Class of protection against electric shock	Class II conforming to VDE 0106-1

Vibration resistance	3.5 mm (f = 3...11.9 Hz) conforming to EN/IEC 61131-2 2 gn (f = 11.9...150 Hz) conforming to EN/IEC 61131-2
Dielectric strength	500 V between input and ground 500 V between output and ground
Product certifications	CCSAus UL
Environmental characteristic	EMC conforming to EN 61000-6-3 EMC conforming to EN/IEC 61000-6-2 Safety conforming to EN/IEC 60950-1 Safety conforming to EN/IEC 61204-3

24 Vdc/20 A Battery Control Module

Dimensions

mm

inch

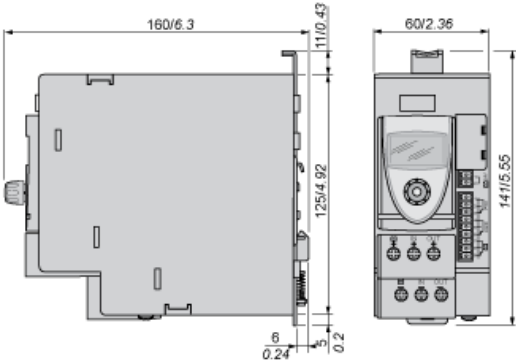

24 Vdc Battery Control Module

Mounting

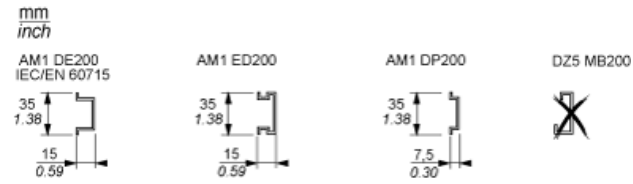

24 Vdc Battery Control Module

Clearance

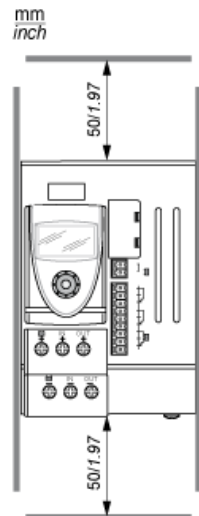

24 Vdc Battery Control Module

Wiring Diagram

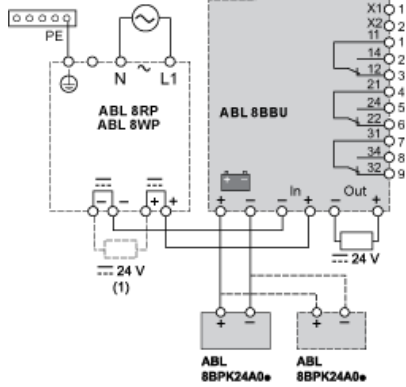

(1) See table below for the maximum unstored charge capacity (μF)

ABL	Max. Unstored Charge Capacity (μF)
8RPS24030	30 000
8RPS24050	50 000
8RPS24100	100 000
8RPS24200	100 000
8RPS24400	100 000

24 Vdc Battery Control Module

Outputs States ($U = 24 \text{ Vdc}: I > 5 \text{ mA}$, $U = 230 \text{ Vac}: I < 500 \text{ mA}$)

	No power from the power supply		Power from the power supply
	Alarm or device not supplied		No alarm
	No power from the battery pack		Power from the battery pack







Inputs States (Dry Contact)

	Operational battery		Battery inhibited
--	---------------------	--	-------------------

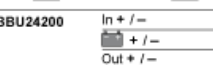





Wiring Requirements

Cable Types and Wire Sizes

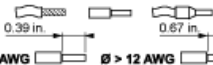
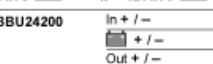
IEC / EN

		ABL 8RPS24030 8RPS24050 8RPS24100	ABL 8RPM24200 8WPS24200 8WPS24400
	$\varnothing \leq 4 \text{ mm}^2$		
	$\varnothing > 4 \text{ mm}^2$		
ABL 8BBU24200	In + / -	1... 4 mm ²	4... 10 mm ²
	 + / -	6 mm ²	-
	Out + / -	6 mm ²	-
ABL 8BBU24400	In + / -	1... 4 mm ²	4... 10 mm ²
	 + / -	10 mm ²	-
	Out + / -	10 mm ²	-
	 ±	10 mm ²	-
		-	-
 OFF / PSU / Alarm / 		0,14... 1 mm ²	-

UL

		ABL 8RPS24030 8RPS24050 8RPS24100	ABL 8RPM24200 8WPS24200 8WPS24400
	$\varnothing \leq 12 \text{ AWG}$		
	$\varnothing > 12 \text{ AWG}$		
ABL 8BBU24200	In + / -	16... 12 AWG	12... 6 AWG
	 + / -	10 AWG	-
	Out + / -	10 AWG	-
ABL 8BBU24400	In + / -	16... 12 AWG	12... 6 AWG
	 + / -	6 AWG	-
	Out + / -	6 AWG	-
	 ±	6 AWG	-
		-	-
 OFF / PSU / Alarm / 		26... 16 AWG	-