

4 Form C Flat type



2 Form C Flat type



4 Form C Slim type
(PC board)



2 Form C Slim type
(PC board)

FEATURES

1. Compact, slim design

Use of high-performance flat electromagnetic design achieves 10.9 mm .429 inch profile, flat type thin package. Slim type, with width of 11.2 mm .441 inch, enables high-density mounting on PC boards.

2. High reliability

Provides stable contact pressure needed for card lift-off contact driver method. The use of Ac clad twin contacts provides stable contact resistance and ensures high contact reliability.

3. 2-coil latching types available

4. Compatible with all major safety standards

UL and CSA certified, and complies with Japanese Electrical Appliance and Material Control Law.

TYPICAL APPLICATIONS

1. Information processing and telecom equipment such as computers and terminal devices.

2. Gas hot air heating equipment and air conditioners.

3. Timer, temperature controller and other equipment that requires form factor reduction.

4. Transmission and measuring devices such as facsimile machines and electronic counting devices.

5. Control panels for industrial equipment such as machine tools, factory automation devices, and NC machines.

RoHS Directive compatibility information
<http://www.mew.co.jp/ac/e/environment/>

ORDERING INFORMATION

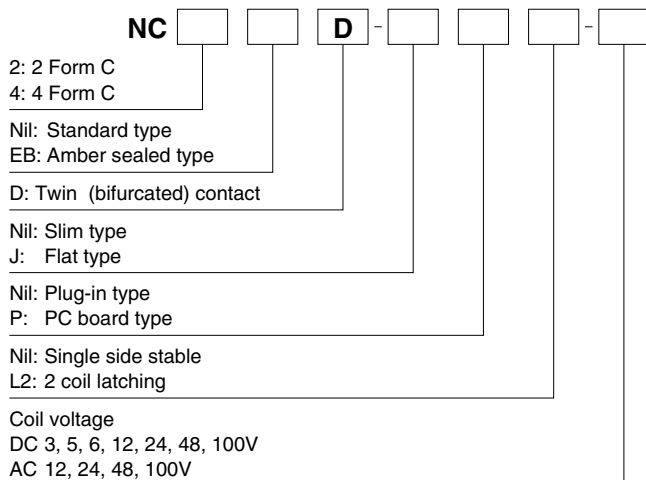

Notes: 1. UL/CSA approved type is standard.
2. Amber sealed types are sealed and filled with inert gas (nitrogen gas).
Sealed construction with terminals, case and base sealed shut with sealing resin.

TYPES

<Standard type>

1. Flat type (PC board terminal)

Contact arrangement	Nominal coil voltage	Single side stable	2 coil latching
		Part No.	Part No.
2 Form C	12V AC	NC2D-JP-AC12V	—
	24V AC	NC2D-JP-AC24V	—
	48V AC	NC2D-JP-AC48V	—
	100V AC	NC2D-JP-AC100V	—
	3V DC	NC2D-JP-DC3V	NC2D-JPL2-DC3V
	5V DC	NC2D-JP-DC5V	NC2D-JPL2-DC5V
	6V DC	NC2D-JP-DC6V	NC2D-JPL2-DC6V
	12V DC	NC2D-JP-DC12V	NC2D-JPL2-DC12V
	24V DC	NC2D-JP-DC24V	NC2D-JPL2-DC24V
	48V DC	NC2D-JP-DC48V	NC2D-JPL2-DC48V
100V DC	NC2D-JP-DC100V	NC2D-JPL2-DC100V	
4 Form C	12V AC	NC4D-JP-AC12V	—
	24V AC	NC4D-JP-AC24V	—
	48V AC	NC4D-JP-AC48V	—
	100V AC	NC4D-JP-AC100V	—
	3V DC	NC4D-JP-DC3V	NC4D-JPL2-DC3V
	5V DC	NC4D-JP-DC5V	NC4D-JPL2-DC5V
	6V DC	NC4D-JP-DC6V	NC4D-JPL2-DC6V
	12V DC	NC4D-JP-DC12V	NC4D-JPL2-DC12V
	24V DC	NC4D-JP-DC24V	NC4D-JPL2-DC24V
	48V DC	NC4D-JP-DC48V	NC4D-JPL2-DC48V
100V DC	NC4D-JP-DC100V	NC4D-JPL2-DC100V	

Standard packing: Carton: 20 pcs.; Case: 200 pcs.

2. Slim type

1) Plug-in type

Contact arrangement	Nominal coil voltage	Single side stable	2 coil latching
		Part No.	Part No.
2 Form C	12V AC	NC2D-AC12V	—
	24V AC	NC2D-AC24V	—
	48V AC	NC2D-AC48V	—
	100V AC	NC2D-AC100V	—
	3V DC	NC2D-DC3V	NC2D-L2-DC3V
	5V DC	NC2D-DC5V	NC2D-L2-DC5V
	6V DC	NC2D-DC6V	NC2D-L2-DC6V
	12V DC	NC2D-DC12V	NC2D-L2-DC12V
	24V DC	NC2D-DC24V	NC2D-L2-DC24V
	48V DC	NC2D-DC48V	NC2D-L2-DC48V
100V DC	NC2D-DC100V	NC2D-L2-DC100V	
4 Form C	12V AC	NC4D-AC12V	—
	24V AC	NC4D-AC24V	—
	48V AC	NC4D-AC48V	—
	100V AC	NC4D-AC100V	—
	3V DC	NC4D-DC3V	NC4D-L2-DC3V
	5V DC	NC4D-DC5V	NC4D-L2-DC5V
	6V DC	NC4D-DC6V	NC4D-L2-DC6V
	12V DC	NC4D-DC12V	NC4D-L2-DC12V
	24V DC	NC4D-DC24V	NC4D-L2-DC24V
	48V DC	NC4D-DC48V	NC4D-L2-DC48V
100V DC	NC4D-DC100V	NC4D-L2-DC100V	

Standard packing: Carton: 20 pcs.; Case: 200 pcs.

2) PC board type

Contact arrangement	Nominal coil voltage	Single side stable	2 coil latching
		Part No.	Part No.
2 Form C	12V AC	NC2D-P-AC12V	—
	24V AC	NC2D-P-AC24V	—
	48V AC	NC2D-P-AC48V	—
	100V AC	NC2D-P-AC100V	—
	3V DC	NC2D-P-DC3V	NC2D-PL2-DC3V
	5V DC	NC2D-P-DC5V	NC2D-PL2-DC5V
	6V DC	NC2D-P-DC6V	NC2D-PL2-DC6V
	12V DC	NC2D-P-DC12V	NC2D-PL2-DC12V
	24V DC	NC2D-P-DC24V	NC2D-PL2-DC24V
	48V DC	NC2D-P-DC48V	NC2D-PL2-DC48V
100V DC	NC2D-P-DC100V	NC2D-PL2-DC100V	
4 Form C	12V AC	NC4D-P-AC12V	—
	24V AC	NC4D-P-AC24V	—
	48V AC	NC4D-P-AC48V	—
	100V AC	NC4D-P-AC100V	—
	3V DC	NC4D-P-DC3V	NC4D-PL2-DC3V
	5V DC	NC4D-P-DC5V	NC4D-PL2-DC5V
	6V DC	NC4D-P-DC6V	NC4D-PL2-DC6V
	12V DC	NC4D-P-DC12V	NC4D-PL2-DC12V
	24V DC	NC4D-P-DC24V	NC4D-PL2-DC24V
	48V DC	NC4D-P-DC48V	NC4D-PL2-DC48V
100V DC	NC4D-P-DC100V	NC4D-PL2-DC100V	

Standard packing: Carton: 20 pcs.; Case: 200 pcs.

<Amber type>

1. Flat type (PC board terminal)

Contact arrangement	Nominal coil voltage	Single side stable	2 coil latching
		Part No.	Part No.
2 Form C	3V DC	NC2EBD-JP-DC3V	NC2EBD-JPL2-DC3V
	5V DC	NC2EBD-JP-DC5V	NC2EBD-JPL2-DC5V
	6V DC	NC2EBD-JP-DC6V	NC2EBD-JPL2-DC6V
	12V DC	NC2EBD-JP-DC12V	NC2EBD-JPL2-DC12V
	24V DC	NC2EBD-JP-DC24V	NC2EBD-JPL2-DC24V
	48V DC	NC2EBD-JP-DC48V	NC2EBD-JPL2-DC48V
	100V DC	NC2EBD-JP-DC100V	NC2EBD-JPL2-DC100V
4 Form C	3V DC	NC4EBD-JP-DC3V	NC4EBD-JPL2-DC3V
	5V DC	NC4EBD-JP-DC5V	NC4EBD-JPL2-DC5V
	6V DC	NC4EBD-JP-DC6V	NC4EBD-JPL2-DC6V
	12V DC	NC4EBD-JP-DC12V	NC4EBD-JPL2-DC12V
	24V DC	NC4EBD-JP-DC24V	NC4EBD-JPL2-DC24V
	48V DC	NC4EBD-JP-DC48V	NC4EBD-JPL2-DC48V
100V DC	NC4EBD-JP-DC100V	NC4EBD-JPL2-DC100V	

Standard packing: Carton: 20 pcs.; Case: 200 pcs.

2. Slim type

1) Plug-in type

Contact arrangement	Nominal coil voltage	Single side stable	2 coil latching
		Part No.	Part No.
2 Form C	3V DC	NC2EBD-DC3V	NC2EBD-L2-DC3V
	5V DC	NC2EBD-DC5V	NC2EBD-L2-DC5V
	6V DC	NC2EBD-DC6V	NC2EBD-L2-DC6V
	12V DC	NC2EBD-DC12V	NC2EBD-L2-DC12V
	24V DC	NC2EBD-DC24V	NC2EBD-L2-DC24V
	48V DC	NC2EBD-DC48V	NC2EBD-L2-DC48V
	100V DC	NC2EBD-DC100V	NC2EBD-L2-DC100V
4 Form C	3V DC	NC4EBD-DC3V	NC4EBD-L2-DC3V
	5V DC	NC4EBD-DC5V	NC4EBD-L2-DC5V
	6V DC	NC4EBD-DC6V	NC4EBD-L2-DC6V
	12V DC	NC4EBD-DC12V	NC4EBD-L2-DC12V
	24V DC	NC4EBD-DC24V	NC4EBD-L2-DC24V
	48V DC	NC4EBD-DC48V	NC4EBD-L2-DC48V
100V DC	NC4EBD-DC100V	NC4EBD-L2-DC100V	

Standard packing: Carton: 20 pcs.; Case: 200 pcs.

NC

2) PC board type

Contact arrangement	Nominal coil voltage	Single side stable	2 coil latching
		Part No.	Part No.
2 Form C	3V DC	NC2EBD-P-DC3V	NC2EBD-PL2-DC3V
	5V DC	NC2EBD-P-DC5V	NC2EBD-PL2-DC5V
	6V DC	NC2EBD-P-DC6V	NC2EBD-PL2-DC6V
	12V DC	NC2EBD-P-DC12V	NC2EBD-PL2-DC12V
	24V DC	NC2EBD-P-DC24V	NC2EBD-PL2-DC24V
	48V DC	NC2EBD-P-DC48V	NC2EBD-PL2-DC48V
4 Form C	100V DC	NC2EBD-P-DC100V	NC2EBD-PL2-DC100V
	3V DC	NC4EBD-P-DC3V	NC4EBD-PL2-DC3V
	5V DC	NC4EBD-P-DC5V	NC4EBD-PL2-DC5V
	6V DC	NC4EBD-P-DC6V	NC4EBD-PL2-DC6V
	12V DC	NC4EBD-P-DC12V	NC4EBD-PL2-DC12V
	24V DC	NC4EBD-P-DC24V	NC4EBD-PL2-DC24V
4 Form C	48V DC	NC4EBD-P-DC48V	NC4EBD-PL2-DC48V
	100V DC	NC4EBD-P-DC100V	NC4EBD-PL2-DC100V

Standard packing: Carton: 20 pcs.; Case: 200 pcs.

RATING

1. Coil data

1) Single side stable type (AC)

No. of poles	Nominal coil voltage	Pick-up voltage (at 20°C 68°F)	Drop-out voltage (at 20°C 68°F)	Nominal operating current [±10%] (at 20°C 68°F)	Coil inductance		Nominal operating power	Max. allowable voltage (at 50°C 122°F)
					N.C. condition	N.O. condition		
2 Form C	12V AC	80%V or less of nominal voltage (Initial)	10%V or more of nominal voltage (Initial)	41.5mA	—	—	0.50VA	110%V of nominal voltage
	24V AC			22.5mA	—	—	0.54VA	
	48V AC			14.0mA	—	—	0.67VA	
	100V AC			10.5mA	—	—	1.05VA	
4 Form C	12V AC	80%V or less of nominal voltage (Initial)	10%V or more of nominal voltage (Initial)	92mA	—	—	1.10VA	110%V of nominal voltage
	24V AC			45mA	—	—	1.08VA	
	48V AC			22.5mA	—	—	1.08VA	
	100V AC			13.0mA	—	—	1.30VA	

2) Single side stable (DC)

No. of poles	Nominal coil voltage	Pick-up voltage (at 20°C 68°F)	Drop-out voltage (at 20°C 68°F)	Nominal operating current [±10%] (at 20°C 68°F)	Coil resistance [±10%] (at 20°C 68°F)	Nominal operating power	Coil inductance		Max. allowable voltage (at 50°C 122°F)*
							N.C. condition	N.O. condition	
2 Form C	3V DC	80%V or less of nominal voltage (Initial)	10%V or more of nominal voltage (Initial)	120mA	25Ω	360mW	24.2mH	30.0mH	135%V of nominal voltage
	5V DC			72mA	69.4Ω	360mW	69.5mH	86.0mH	
	6V DC			60mA	100Ω	360mW	99.4mH	123mH	
	12V DC			30mA	400Ω	360mW	388mH	480mH	
	24V DC			15mA	1,600Ω	360mW	1,590mH	1,970mH	
	48V DC			7.5mA	6,400Ω	360mW	6,270mH	7,680mH	
	100V DC			7.4mA	13,500Ω	740mW	9,470mH	11,700mH	110%V of nominal voltage
4 Form C	3V DC	80%V or less of nominal voltage (Initial)	10%V or more of nominal voltage (Initial)	240mA	12.5Ω	720mW	12.8mH	15.8mH	110%V of nominal voltage
	5V DC			144mA	34.7Ω	720mW	34.3mH	42.4mH	
	6V DC			120mA	50Ω	720mW	50.7mH	62.7mH	
	12V DC			60mA	200Ω	720mW	203mH	252mH	
	24V DC			30mA	800Ω	720mW	812mH	1,000mH	
	48V DC			15mA	3,200Ω	720mW	2,820mH	3,480mH	
	100V DC			7.4mA	13,500Ω	740mW	14,100mH	17,400mH	

* At 20°C 68°F (Amber type)

3) 2 coil latching type

No. of poles	Nominal coil voltage	Set voltage (at 20°C 68°F)	Reset voltage (at 20°C 68°F)	Nominal operating current [$\pm 10\%$] (at 20°C 68°F)		Coil resistance [$\pm 10\%$] (at 20°C 68°F)		Nominal operating power		Coil inductance				Max. allowable voltage (at 50°C 122°F)
				Set coil	Reset coil	Set coil	Reset coil	Set coil	Reset coil	Set coil		Reset coil		
										N.C. condition	N.O. condition	N.C. condition	N.O. condition	
2 Form C	3V DC	80%V or less of nominal voltage (Initial)	80%V or less of nominal voltage (Initial)	265.5mA	265.5mA	11.3 Ω	11.3 Ω	800mW	800mW	10.8mH	12.4mH	3.85mH	4.01mH	110%V of nominal voltage
	5V DC			159.7mA	159.7mA	31.3 Ω	31.3 Ω	800mW	800mW	29.1mH	38.4mH	11.0mH	11.5mH	
	6V DC			133.3mA	133.3mA	45.0 Ω	45.0 Ω	800mW	800mW	42.9mH	49.3mH	17.4mH	18.1mH	
	12V DC			66.7mA	66.7mA	180 Ω	180 Ω	800mW	800mW	173mH	198mH	62.1mH	64.8mH	
	24V DC			33.3mA	33.3mA	720 Ω	720 Ω	800mW	800mW	688mH	790mH	278mH	290mH	
	48V DC			16.7mA	16.7mA	2,880 Ω	2,880 Ω	800mW	800mW	2,370mH	2,730mH	1,230mH	1,280mH	
100V DC	8.0mA	8.0mA	12,500 Ω	12,500 Ω	800mW	800mW	10,800mH	12,400mH	5,740mH	5,980mH				
4 Form C	3V DC	80%V or less of nominal voltage (Initial)	80%V or less of nominal voltage (Initial)	535.7mA	535.7mA	5.6 Ω	5.6 Ω	1,600mW	1,600mW	5.25mH	6.03mH	1.42mH	1.48mH	110%V of nominal voltage (Within 2 min.)
	5V DC			320.5mA	320.5mA	15.6 Ω	15.6 Ω	1,600mW	1,600mW	13.5mH	15.5mH	3.76mH	3.92mH	
	6V DC			266.7mA	266.7mA	22.5 Ω	22.5 Ω	1,600mW	1,600mW	20.5mH	23.5mH	4.67mH	4.87mH	
	12V DC			133.3mA	133.3mA	90 Ω	90 Ω	1,600mW	1,600mW	87.6mH	101mH	16.3mH	17.0mH	
	24V DC			66.7mA	66.7mA	360 Ω	360 Ω	1,600mW	1,600mW	328mH	376mH	74.9mH	78.1mH	
	48V DC			33.3mA	33.3mA	1,440 Ω	1,440 Ω	1,600mW	1,600mW	1,350mH	1,550mH	289mH	302mH	
100V DC	16.0mA	16.0mA	6,250 Ω	6,250 Ω	1,600mW	1,600mW	5,990mH	6,880mH	1,340mH	1,400mH				

- Notes: 1. Two coil latching relay 4 Form C series are for intermittent operation only. Power should be applied to coil continuously for no more than two minutes.
2. Coil resistance is the measured value at a coil temperature of 20°C 68°F. Compensate coil resistance by $\pm 0.4\%$ for each degree ($^{\circ}\text{C}$ $^{\circ}\text{F}$) of coil temperature change.
3. "Maximum allowable voltage" is that value at maximum contact rating and maximum ambient temperature.
The graph shown in the data describes the inter-relationship; care should be taken to prevent the total of ambient temperature and the coil temperature rise from exceeding 120°C 248°F.

2. Specifications

Characteristics	Item	Specifications						
		DC		AC	DC		AC	
		Single side stable	2 Coil latching	Single side stable	Single side stable	2 Coil latching	Single side stable	
Contact	Arrangement	2 Form C			4 Form C			
	Initial contact resistance, max.	Max. 50 mΩ (By voltage drop 6 V DC 1A)			Max. 50 mΩ (By voltage drop 6 V DC 1A)			
	Contact material	Au-clad AgNi type			Au-clad AgNi type			
Rating	Nominal switching capacity (resistive load)	Standard: 5A 250V AC, 5A 30V DC Amber: 3A 250V AC, 5A 30V DC			Standard: 4A 250V AC, 5A 30V DC Amber: 2A 250V AC, 5A 30V DC			
	Max. switching power (resistive load)	Standard: 1,250VA, 150W Amber: 750VA, 150W			Standard: 1,000VA, 150W Amber: 500VA, 150W			
	Max. switching voltage	250 V AC						
	Max. switching current	Standard: 5A Amber: 3A (AC), 5A (DC)			Standard: 4A Amber: 2A (AC), 5A (DC)			
	Nominal operating power	360mW (740mW: 100V DC)	800mW	0.50VA to 1.05VA	720mW*2	1,600mW	1.08VA to 1.30VA	
	Min. switching capacity (Reference value)*1	100μA 1V DC			100μA 1VDC			
Electrical characteristics	Insulation resistance (Initial)		Min. 100MΩ (at 500V DC) Measurement at same location as "Initial breakdown voltage" section.			Min. 100MΩ (at 500V DC) Measurement at same location as "Initial breakdown voltage" section.		
	Breakdown voltage (Initial)	Between open contacts	1,000 Vrms for 1min. (Detection current: 10mA.)			1,000 Vrms for 1min. (Detection current: 10mA.)		
		Between contact sets	1,000 Vrms for 1min. (Detection current: 10mA.)			1,000 Vrms for 1min. (Detection current: 10mA.)		
		Between contact and coil	2,000 Vrms for 1min. (Detection current: 10mA.)			2,000 Vrms for 1min. (Detection current: 10mA.)		
	Temperature rise		Max. 65°C [Max. 85°C (100V AC)] (By resistive method, nominal voltage)					
	Operate time (at 20°C 68°F)		Max. 20ms	Set time: Max. 20ms	Max. 30ms*3	Max. 20ms	Set time: Max. 20ms	Max. 30ms*3
	Release time (at 20°C 68°F)		Max. 10ms	Reset time: Max. 20ms	Max. 40ms*3	Max. 10ms	Reset time: Max. 20ms	Max. 40ms*3
Mechanical characteristics	Shock resistance	Functional	Min. 98 m/s ² (Half-wave pulse of sine wave: 11 ms; detection time: 10μs.)					
		Destructive	Min. 980 m/s ² (Half-wave pulse of sine wave: 6 ms.)					
Vibration resistance	Functional	10 to 55 Hz at double amplitude of 1 mm (Detection time: 10μs.)						
	Destructive	10 to 55 Hz at double amplitude of 2 mm						
Expected life	Mechanical	Min. 5×10 ⁷	Min. 5×10 ⁷	Min. 10 ⁷	Min. 5×10 ⁷	Min. 5×10 ⁷	Min. 10 ⁷	
	Electrical (resistive load)	Standard: Min. 10 ⁵ (5A 250V AC), Min. 5×10 ⁵ (5A 30V DC) Amber: Min. 10 ⁵ (3A 250V AC), Min. 5×10 ⁵ (5A 30V DC)			Standard: Min. 10 ⁵ (4A 250V AC), Min. 5×10 ⁵ (5A 30V DC) Amber: Min. 10 ⁵ (2A 250V AC), Min. 5×10 ⁵ (5A 30V DC)			
Conditions	Conditions for operation, transport and storage*4 (Not freezing and condensing at low temperature)	-40°C to +70°C -40°F to +158°F (Max. 48V DC), -40°C to +55°C -40°F to +131°F (100V DC)	-40°C to +55°C -40°F to +131°F	-40°C to +60°C -40°F to +140°F*5	-40°C to +55°C -40°F to +131°F		-40°C to +40°C -40°F to +104°F	
	Max. Operating speed	50 cps			50 cps			
Unit weight	16 g .56 oz			18 g .63 oz				

Notes: *1 This value can change due to the switching frequency, environmental conditions, and desired reliability level, therefore it is recommended to check this with the actual load.

*2. 100V DC: 740mW

*3. For the AC type, the operate and release time differs depending on the phase of the input and cutoff times.

*4. Refer to 6. Conditions for operation, transport and storage mentioned in AMBIENT ENVIRONMENT.

*5. 100V DC: -40°C to +40°C -40°F to +104°F

REFERENCE DATA (Standard type)

1.-(1) Life curve
(AC/DC load 2 Form C, 4 Form C)

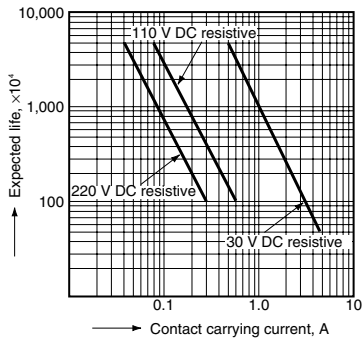

1.-(2) Life curve (AC/DC load 2 Form C)

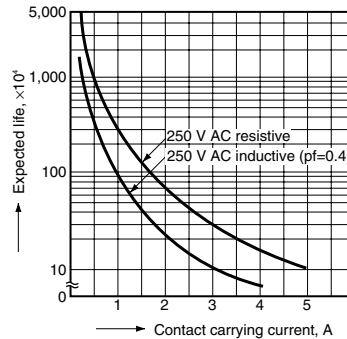

1.-(3) Life curve (AC/DC load 4 Form C)

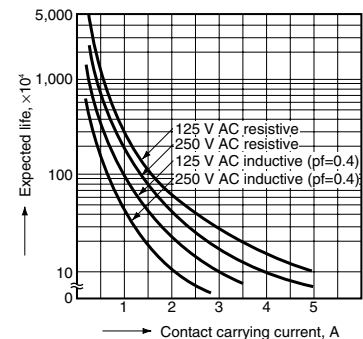

2.-(1) Temperature rise characteristics
(single side stable)
Measured portion: Inside the coil

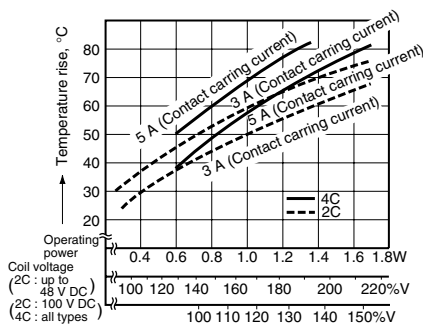

2.-(2) Temperature rise characteristics
(2 coil latching)
Measured portion: Inside the coil

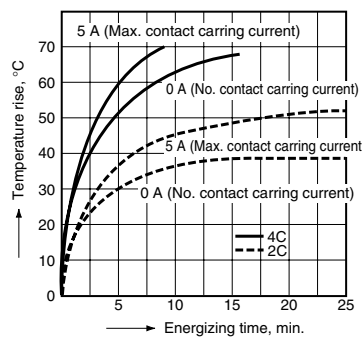

3. Operate time (single side stable)

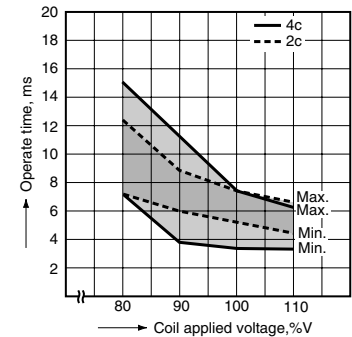

4. Release time (single side stable)

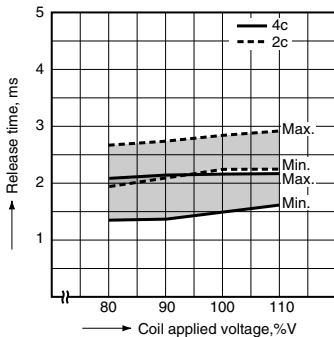

5.-(1) Rate of change of pick-up and drop-out voltage
(2 Form C single side stable)

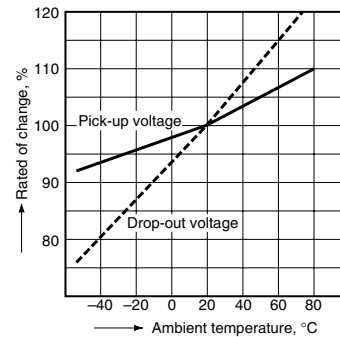

5.-(2) Rate of change of pick-up and drop-out voltage
(4 Form C single side stable)

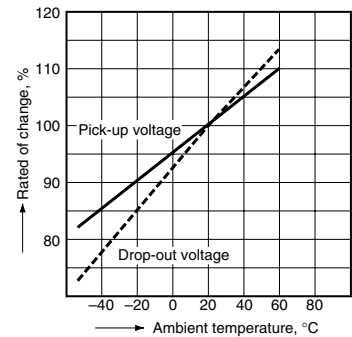

6.-(1) Ambient temperature vs Max. continuous voltage
Tested sample:
NC2D-P-DC24 V (2 Form C slim single side stable)

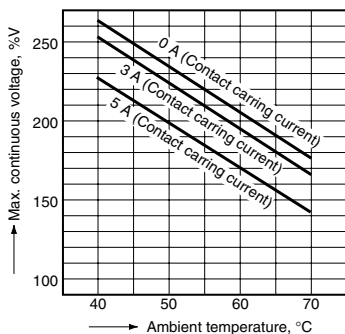

6.-(2) Ambient temperature vs Max. continuous voltage
Tested sample:
NC2D-P-DC110 V (2 Form C slim single side stable),
NC4D-P-DC24 V (4 Form C slim single side stable)

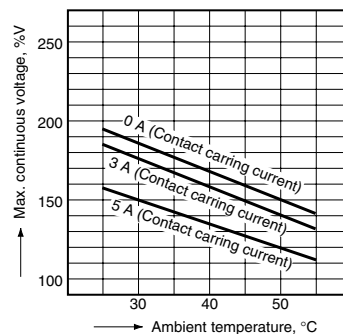

NC

DIMENSIONS (Unit: mm inch)

<Standard type>

Flat type
2 Form C

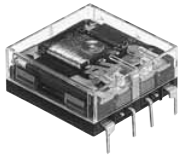

External dimensions

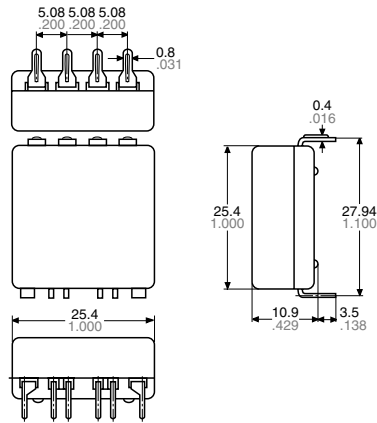

Schematic (Top view)
Single side stable

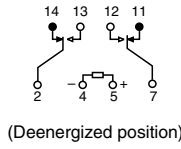

PC board pattern (Bottom view)
Single side stable

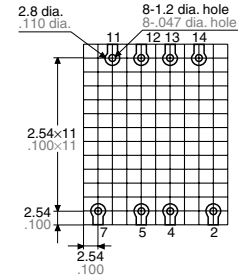

2 coil latching

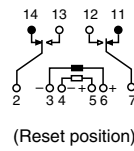

2 coil latching

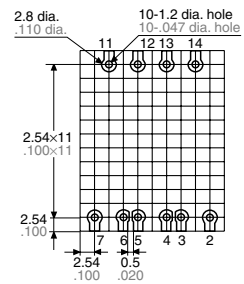

Note: Single side stable types do not have terminals 3 and 6.

Flat type
4 Form C

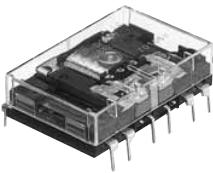

External dimensions

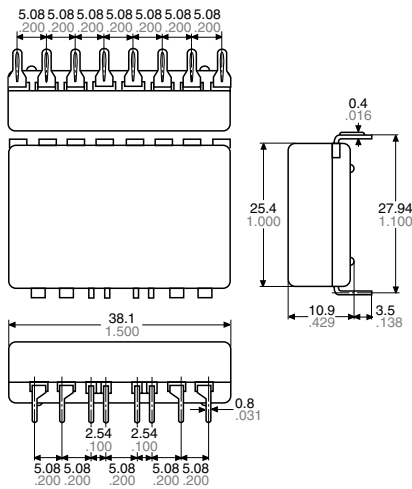

Schematic (Top view)
Single side stable

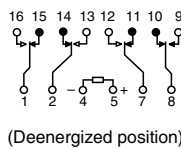

PC board pattern (Bottom view)
Single side stable

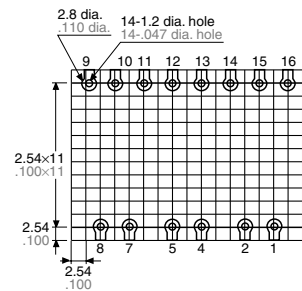

2 coil latching

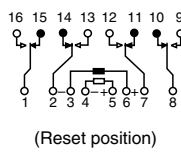

2 coil latching

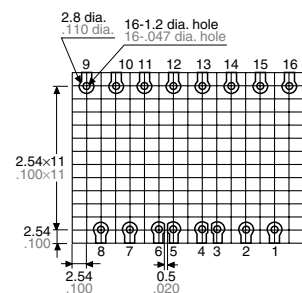

Note: Single side stable types do not have terminals 3 and 6.

Slim type
Plug-in type
2 Form C



External dimensions

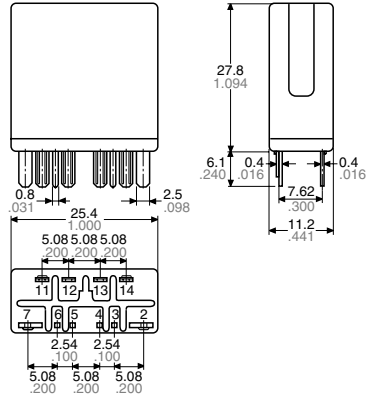

Schematic (Bottom view)

Single side stable

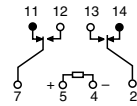

(Deenergized position)

2 coil latching

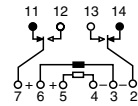

(Reset position)

Note: Single side stable types do not have terminals 3 and 6.

Slim type
Plug-in type
4 Form C

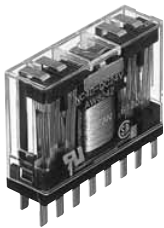

External dimensions

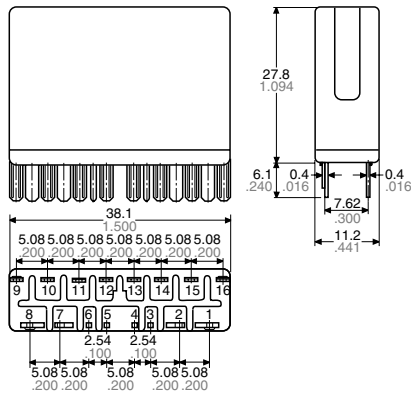

Schematic (Bottom view)

Single side stable

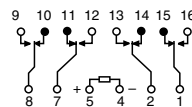

(Deenergized position)

2 coil latching

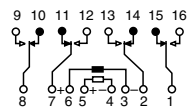

(Reset position)

Note: Single side stable types do not have terminals 3 and 6.

Slim type
PC board type
2 Form C



External dimensions

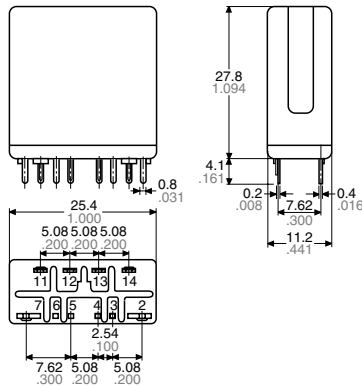

(Dowel height: 0.4 .016)

Schematic (Bottom view)

Single side stable

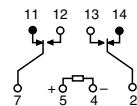

(Deenergized position)

PC board pattern (Bottom view)

Single side stable

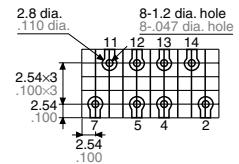

2 coil latching

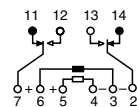

(Reset position)

2 coil latching

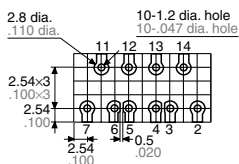

Note: Single side stable types do not have terminals 3 and 6.

NC

Slim type
PC board type
4 Form C

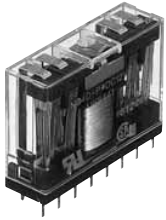

External dimensions

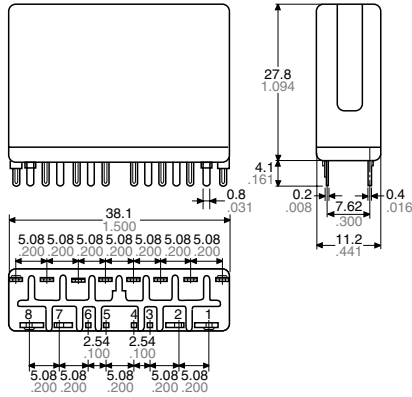

(Dowel height: 0.4 .016)

Schematic (Bottom view)

Single side stable

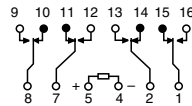

(Deenergized position)

2 coil latching

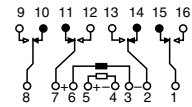

(Reset position)

PC board pattern (Bottom view)

Single side stable

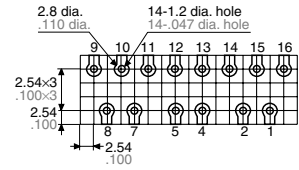

2 coil latching

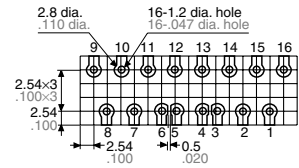

Note: Single side stable types do not have terminals 3 and 6.

<Amber sealed type>

Flat type
2 Form C



External dimensions

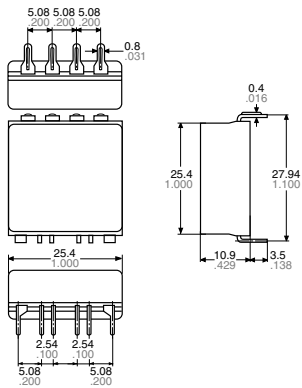

Schematic (Top view)

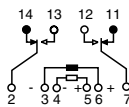

(Single side stable:
Deenergized position
2 coil latching:
Reset position)

PC board pattern (Bottom view)

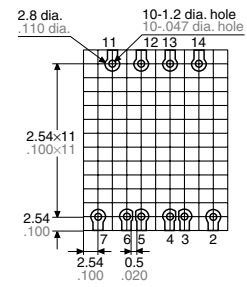

Note: Single side stable types do not have terminals 3 and 6.

Flat type
4 Form C



External dimensions

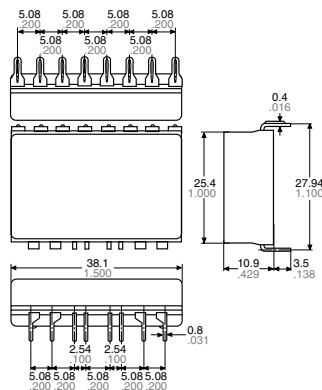

Schematic (Top view)

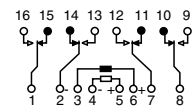

(Single side stable:
Deenergized position
2 coil latching:
Reset position)

PC board pattern (Bottom view)

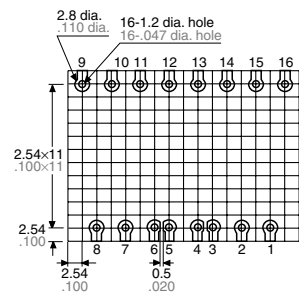

Note: Single side stable types do not have terminals 3 and 6.

Slim type
Plug-in type
2 Form C



External dimensions

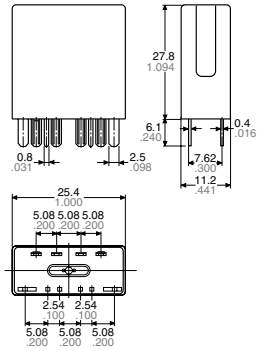

Schematic (Bottom view)

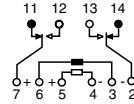

(Single side stable:
Deenergized position
2 coil latching:
Reset position)

Note: Single side stable types do not have terminals 3 and 6.

Slim type
Plug-in type
4 Form C



External dimensions

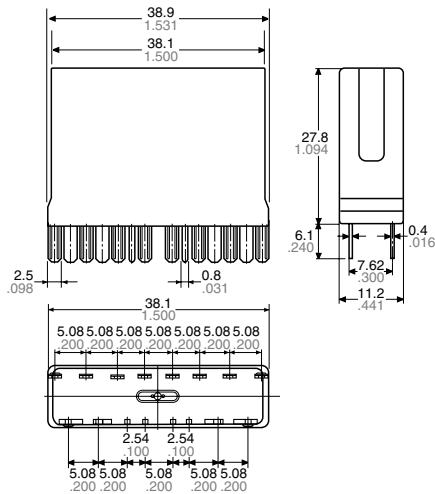

Schematic (Bottom view)

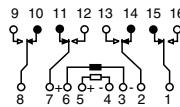

(Single side stable:
Deenergized position
2 coil latching:
Reset position)

Note: Single side stable types do not have terminals 3 and 6.

Slim type
PC board type
2 Form C



External dimensions

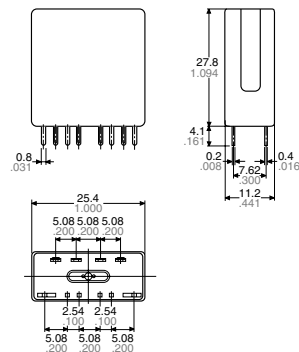

Schematic (Bottom view)

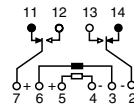

(Single side stable:
Deenergized position
2 coil latching:
Reset position)

PC board pattern (Bottom view)

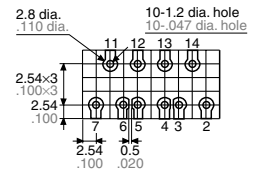

Note: Single side stable types do not have terminals 3 and 6.

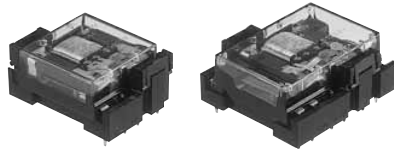

NC2 Flat type socket



NC4 Flat type socket



NC2 Slim type socket



NC4 Slim type socket



NC2 DIN terminal socket

FEATURES

• **Socket**

1) The vertical (slim) type with solder terminals has a retainer, which enables snap-in fixing on chassis, panels, and similar locations. Because the sockets for both solder terminals and PC boards firmly fix the relay at the time of insertion, once snapped in, spring clips are unnecessary.

2) For the flat type, pull up the hinged clasps in the direction of the arrows shown in the drawing after inserting the relay. Spring clips are unnecessary.

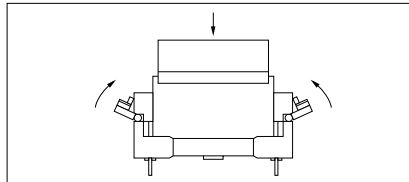

RoHS Directive compatibility information
<http://www.mew.co.jp/ac/e/environment/>

TYPES

	Product name	Terminals	Part No.
Flat type socket	NC2-flat type PC board socket	P/C board	NC2-JPS
	NC2-flat, 2 coil latching type PC board socket	P/C board	NC2-JPL2S
	NC4-flat type PC board socket	P/C board	NC4-JPS
	NC4-flat, 2 coil latching type PC board socket	P/C board	NC4-JPL2S
Slim type terminal socket	NC2-DIN terminal socket	DIN rail	NC2-SFD
Slim type socket	NC2-slim type socket	Solder	NC2-SS
	NC2-slim, 2 coil latching type socket	Solder	NC2-LS2
	NC2-slim type PC board socket	P/C board	NC2-PS
	NC2-slim, 2 coil latching type PC board socket	P/C board	NC2-L2P
	NC2-slim type wrapping socket	Lead wire	NC2-WS
	NC2-slim, 2 coil latching type wrapping socket	Lead wire	NC2-LSWS
	NC4-slim type socket	Solder	NC4-SS
	NC4-slim, 2 coil latching type socket	Solder	NC4-LS2
	NC4-slim type PC board socket	P/C board	NC4-PS
	NC4-slim, 2 coil latching type PC board socket	P/C board	NC4-L2P
	NC4-slim type wrapping socket	Lead wire	NC4-WS
	NC4-slim, 2 coil latching type wrapping socket	Lead wire	NC4-LSWS

SPECIFICATIONS (common)

Item	Specifications
Max. continuous current	Slim type: 5A 250V AC, Flat type: 5A 250V AC
Initial breakdown voltage	2,000 V AC (Except for coil to coil of L2 type: 1,500 V AC)
Initial insulation resistance	Min. 100MΩ (at 500V DC megger)
Heat resistance	150°C 302°F for 1 hour

Note: Do not insert or remove relays while in the energized condition.

NC

DIMENSIONS (Unit: mm inch)

Flat type socket

for PC board

NC2-JPS

NC2-JPL2S



External dimensions

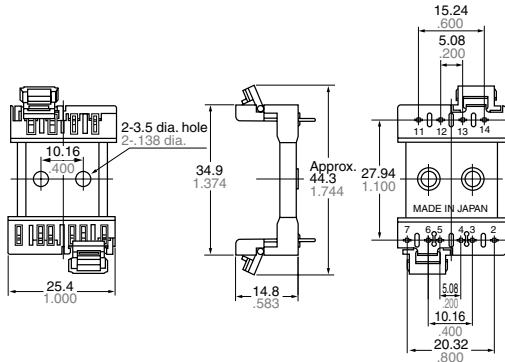

Terminal portion

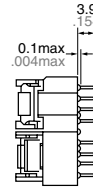

PC board pattern

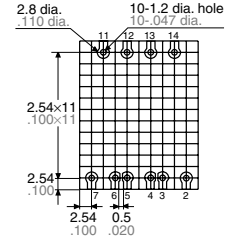

Note: Terminals 3 and 6 excluded for NC2-JPS.

Flat type socket

for PC board

NC4-JPS

NC4-JPL2S



External dimensions

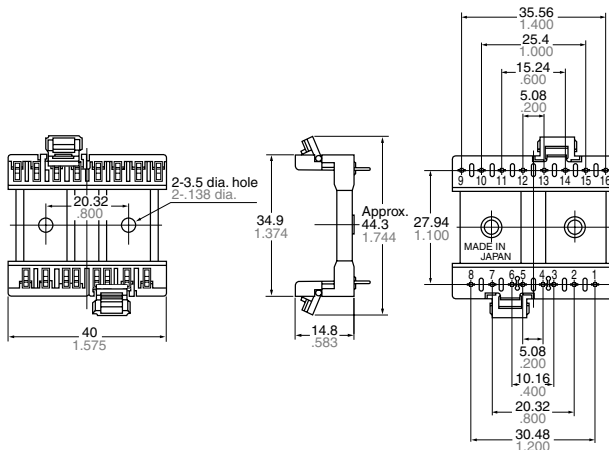

Terminal portion

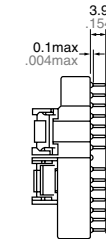

PC board pattern

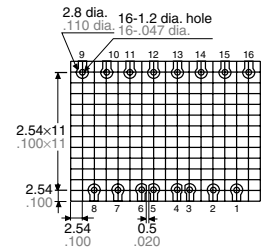

Note: Terminals 3 and 6 excluded for NC4-JPS.

Slim type

DIN terminal socket

NC2-SFD

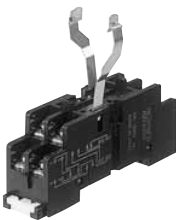

External dimensions

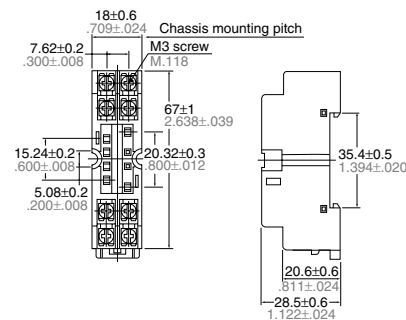

Mounting hole diagram

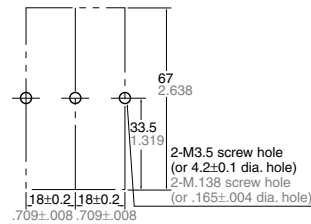

Schematic

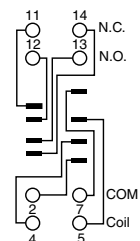

(Retaining springs are included with the DIN terminal socket.)

*To prevent damage or distortion, when tightening fixing screws, the optimum torque range should be 0.49 to 0.69 N·m, (5 to 7 kgf·cm).

Slim type socket for solder terminal

NC2-SS
NC2-L2S

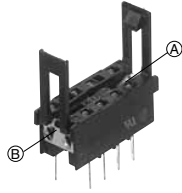

External dimensions

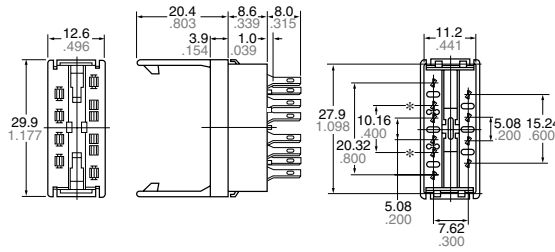

Chassis cutout

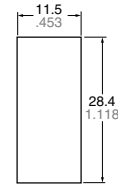

- Notes: 1. Suitable chassis thickness is 1.0 to 2.0 mm .039 to .079 inch.
2. Once the socket is inserted from above into the mounting holes, the relay will snap in to clips rising from either side at (A) and (B) by pushing.

Note: NC2-SS is as shown in the diagram above except that terminals marked with "*" are not present.

Slim type socket for solder terminal

NC4-SS
NC4-L2S

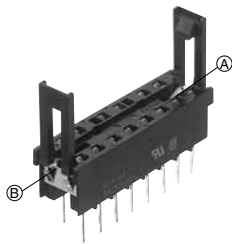

External dimensions

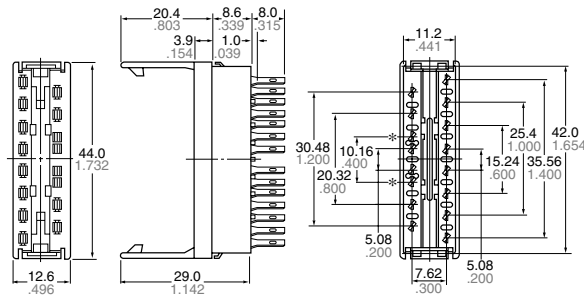

Chassis cutout

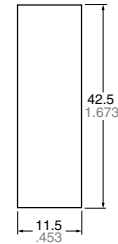

- Notes: 1. Suitable chassis thickness is 1.0 to 2.0 mm .039 to .079 inch.
2. Once the socket is inserted from above into the mounting holes, the relay will snap in to clips rising from either side at (A) and (B) by pushing.

Note: NC4-SS is as shown in the diagram above except that terminals marked with "*" are not present.

Slim type socket for PC board

NC2-PS
NC2-L2P



External dimensions

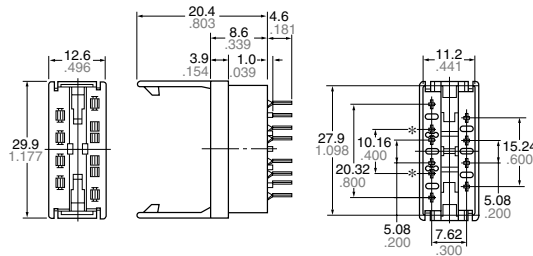

PC board pattern

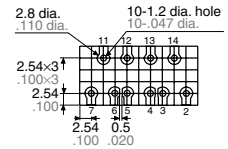

Note: NC2-PS is as shown in the diagram at left except that terminals marked with "*" are not present.

Slim type socket for PC board

NC4-PS
NC4-L2P



External dimensions

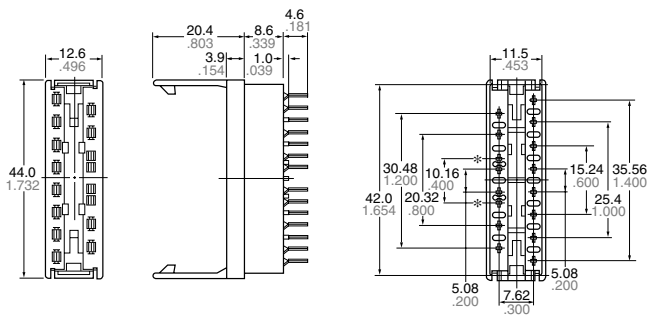

PC board pattern

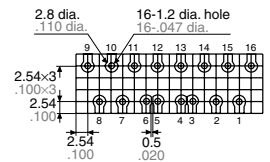

Note: NC4-PS is as shown in the diagram at left except that terminals marked with "*" are not present.

NC

Vertical (Slim) type wrapping socket

NC2-WS
NC2-L2WS

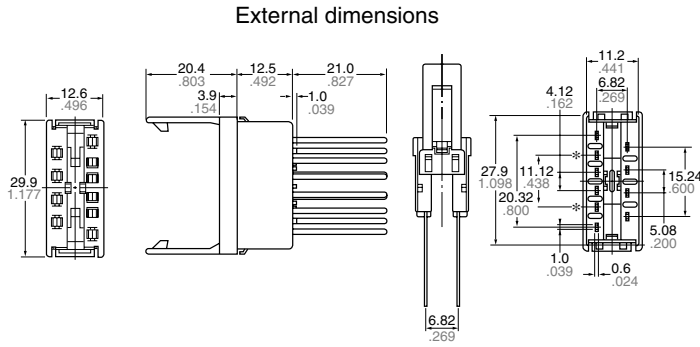

Terminal cross section

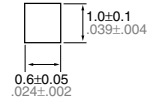

Chassis cutout

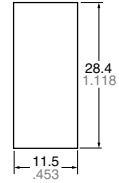

Note: NC2-WS is as shown in the diagram above except that terminals marked with “*” are not present.

Vertical (Slim) type wrapping socket

NC4-WS
NC4-L2WS

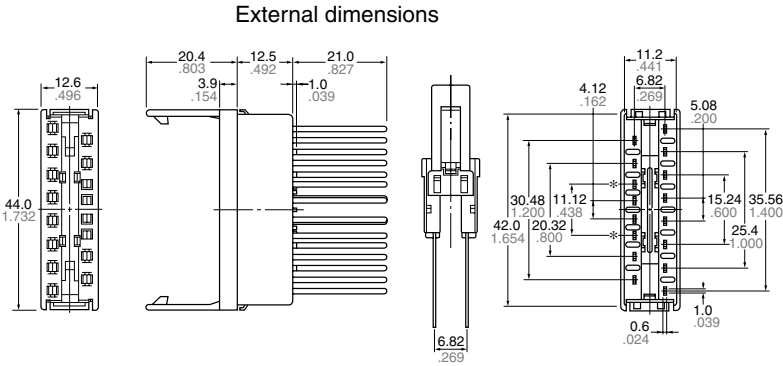

Chassis cutout

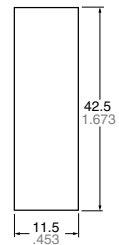

Note: NC4-WS is as shown in the diagram above except that terminals marked with “*” are not present.

NOTES

1. Soldering should be done quickly to avoid damaging the thermoplastic body.
2. For solder terminal types, connect terminals as shown in the diagram at right to maintain insulation distance.

