

FEATURES

- Load Voltage, 15 V
- Load Current, 150 mA
- Switching Capability up to 50 MHz
- Blocking Capability Dependent upon Signal dv/dt
- Low and Typical R_{ON} 5.0 Ω
- 1.0 ms Actuation Time
- Low Power Consumption
- 3750 V_{RMS} I/O Isolation
- Balanced Switching
- Linear AC/DC Operation
- Clean, Bounce-free Switching
- Surface-mountable

AGENCY APPROVALS

- UL – File No. E52744
- CSA – Certification 093751
- VDE 0884 Approval

APPLICATIONS

- Protection Switching (T1 sparing)
 - Digital Access Cross Connects
 - D-type Channel Breaks
 - Intraoffice Data Routing
- Transmission Switching
 - T1 Multiplexing
 - DSO (64 Kbits/s)
 - DS1 (1.544 Mbits/s)
 - E1, DS1A (2.048 Mbits/s)
 - DS1C (3.152 Mbits/s)
 - DS2 (6.312 Mbits/s)
- Instrumentation
 - Scanners
 - Testers
 - Measurement Equipment
- See Application Note

Part Identification

Part Number	Description
LH1514AB	8-pin DIP, Tubes
LH1514AAC	8-pin SMD, Gullwing, Tubes
LH1514AACTR	8-pin SMD, Gullwing, Tape and Reel

Package Dimensions in Inches (mm)

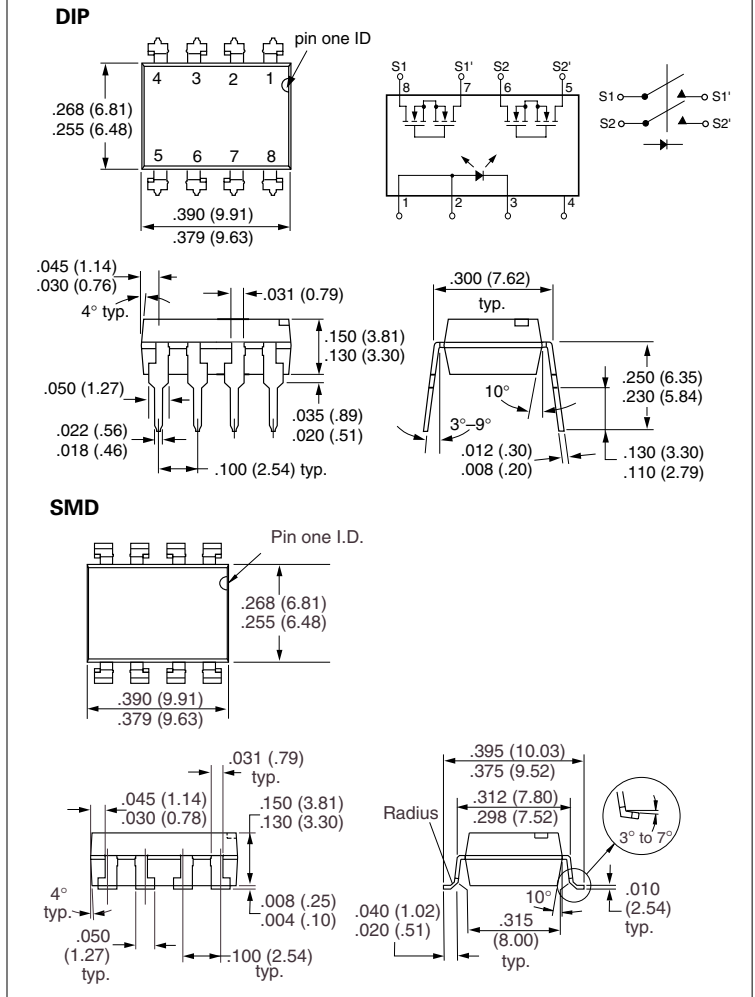

DESCRIPTION

The LH1514 is a DPST normally open (2 Form A) SSR that can be used in balanced high-frequency applications like T1 switching. With its low ON-resistance and high actuation rate, the LH1514 is also very attractive as a general-purpose 2 Form A SSR for balanced signals.

The relays are constructed using a GaAlAs LED for actuation control and an integrated monolithic die for the switch output. The die, fabricated in a dielectrically isolated Smart Power BiCMOS, is comprised of a photodiode array, switch control circuitry, and NMOS switches.

In balanced switching applications, internal circuitry shunts high-frequency signals between two poles when the SSR is off. This balanced T termination technique provides high isolation for the load.

Recommended Operating Conditions

Parameter	Sym.	Min.	Typ.	Max.	Unit
LED Forward Current for Switch Turn-on ($T_A = -40^\circ\text{C}$ to $+85^\circ\text{C}$)	I_{Fon}	10	—	20	mA

Absolute Maximum Ratings, $T_A = 25^\circ\text{C}$

Stresses in excess of the Absolute Maximum Ratings can cause permanent damage to the device. These are absolute stress ratings only. Functional operation of the device is not implied at these or any other conditions in excess of those given in the operational sections of the data sheet. Exposure to maximum rating conditions for extended periods can adversely affect device reliability.

Ambient Operating Temperature Range, T_A -40° to $+85^\circ\text{C}$

Storage Temperature Range, T_{stg} -40° to $+150^\circ\text{C}$

Pin Soldering Temperature, $t = 10$ s max, T_S 260°C

Input/Output Isolation Voltage, V_{ISO} $3750 V_{RMS}$

LED Input Ratings:

Continuous Forward Current, I_F 50 mA

Reverse Voltage, $I_R \leq 10 \mu\text{A}$, V_R 10 V

Output Operation:

dc or Peak ac Load Voltage, $I_L \leq 1.0 \mu\text{A}$, V_L 15 V

Continuous dc Load Current, I_L

Each Pole, Two Poles Operating Simultaneously 150 mA

Power Dissipation, P_{DISS} 600 mW

Electrical Characteristics, $T_A = 25^\circ\text{C}$

Minimum and maximum values are testing requirements. Typical values are characteristics of the device and are the result of engineering evaluations. Typical values are for information purposes only and are not part of the testing requirements.

Parameter	Symbol	Min.	Typ.	Max.	Unit	Test Condition
LED Forward Current, Switch Turn-on	I_{Fon}	—	2.0	5.0	mA	$I_L = 100$ mA, $t = 10$ ms
LED Forward Current, Switch Turn-off	I_{Foff}	0.2	1.8	—	mA	$V_L = \pm 10$ V
LED Forward Voltage	V_F	1.15	1.26	1.45	V	$I_F = 10$ mA
ON-resistance	R_{ON}	2.0	3.0	5.0	Ω	$I_F = 10$ mA, $I_L = \pm 50$ mA
Pole-to-pole ON-resistance Matching (S1 to S2)	—	—	0.2	1.0	D Ω	$I_F = 10$ mA, $I_L = \pm 50$ mA
Output Off-state Bleed-through*	—	—	70	100	mV _{peak}	f = 1.5 MHz square wave $t_r/t_f = 5.0$ ns (See Figure 13.)
Output Off-state Leakage	—	—	3×10^{-12} 20×10^{-12}	200×10^{-9} 1.0×10^{-6}	A A	$I_F = 0$ mA, $V_L = \pm 5.0$ V $V_L = \pm 15$ V
Output Off-state Leakage Pole to Pole	—	—	1.0	5.0	μA	$I_F = 10$ mA Pins 7, 8 ± 3.0 V Pins 5, 6 Gnd
	—	—	2.0	50	μA	Pins 7, 8 ± 15 V Pins 5, 6 Gnd
Output Capacitance Pins 5 to 6, 7 to 8	—	—	20	—	pF	$I_F = 0$ mA, $V_L = 0$
Pole-to-pole Capacitance (S1 to S2)	—	—	20 50	—	pF pF	$I_F = 0$ mA, $V_L = 0$ V $I_F = 10$ mA, $V_L = 0$ V
Turn-on Time	t_{on}	—	0.4	1.0	ms	$I_F = 10$ mA, $I_L = 20$ mA
Turn-off Time	t_{off}	—	0.6	1.0	ms	$I_F = 10$ mA, $I_L = 20$ mA

* Guaranteed by component measurement during wafer probe.

Typical Performance Characteristics

Figure 1. LED Forward Current for Switch Turn-on/off

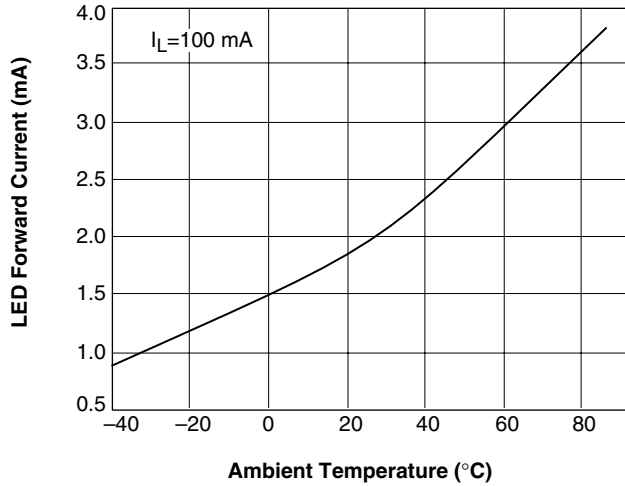

Figure 4. Breakdown Voltage Distribution Typical

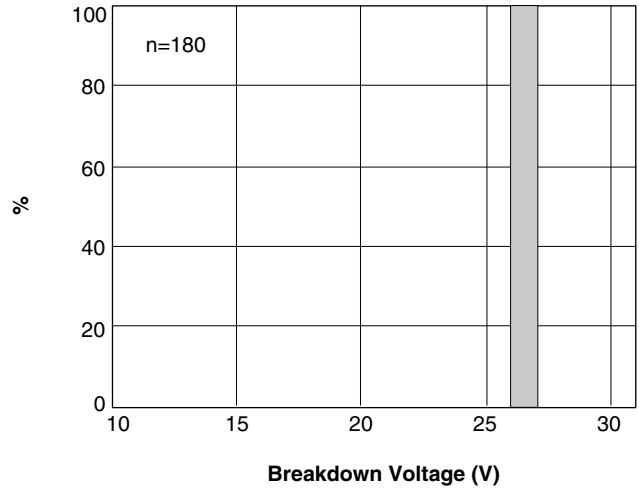

Figure 2. Leakage Current vs. Applied Voltage

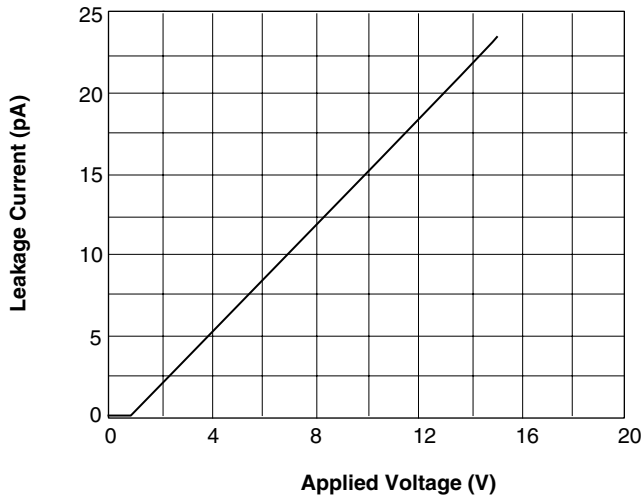

Figure 5. Output Isolation

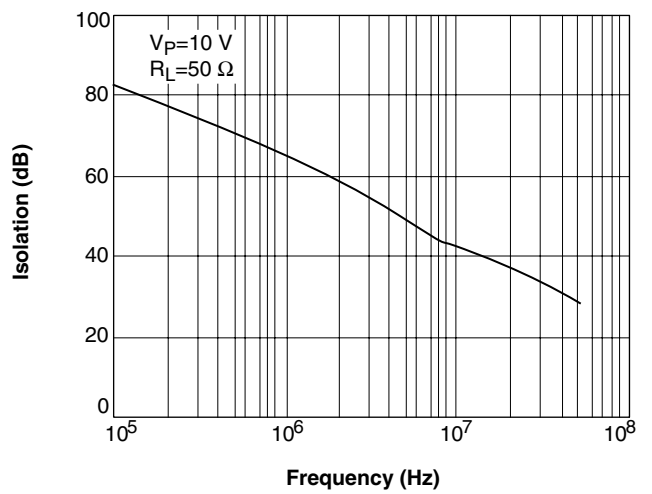

Figure 3. ON-Resistance vs. Temperature

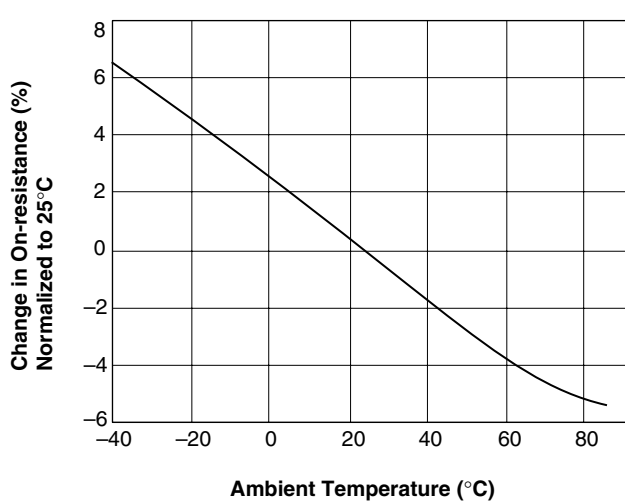

Figure 6. Insertion Loss (per Pole) vs. Frequency

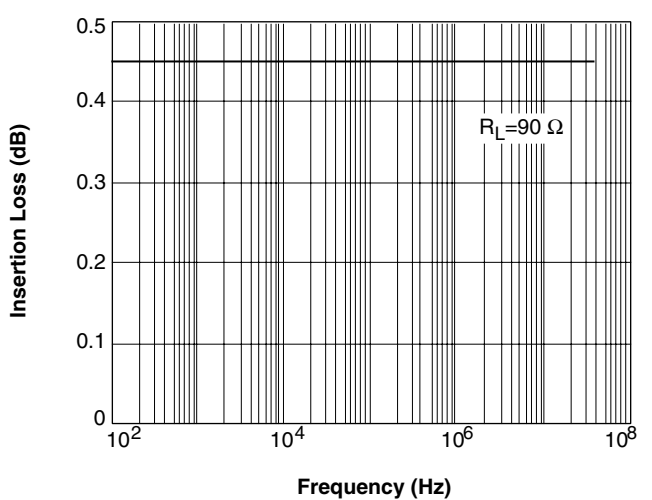

Figure 7. t_{on} vs. LED Forward Current

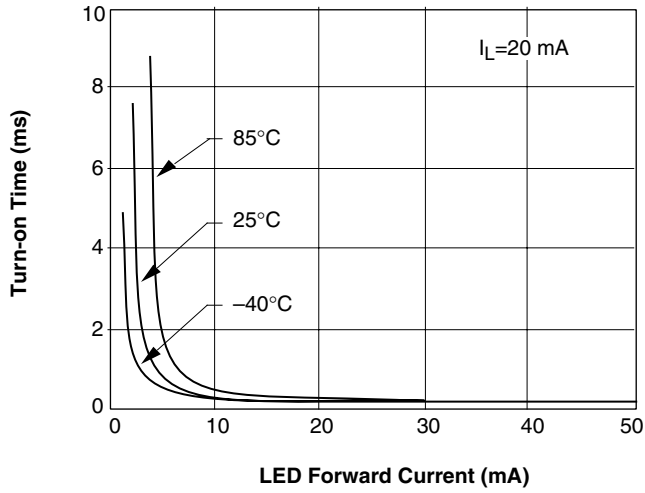

Figure 9. t_{on}/t_{off} vs. Temperature

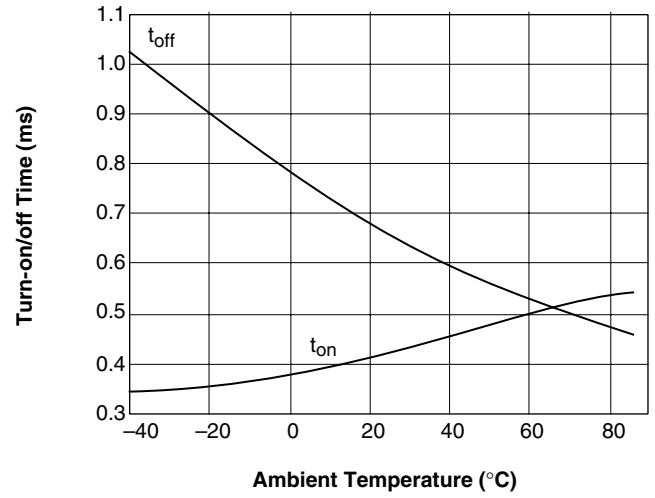

Figure 8. Bleed-through Voltage vs. Rise Time

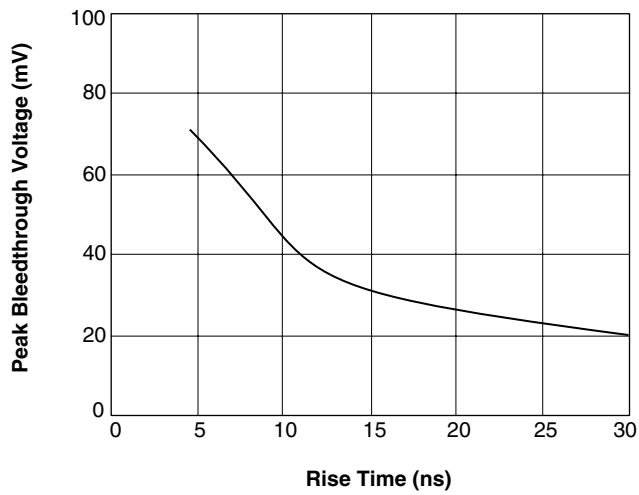
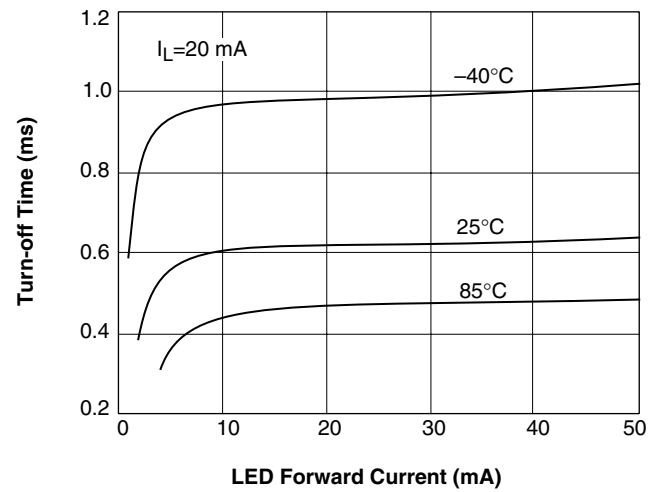

Figure 10. t_{off} vs. LED Forward Current



Functional Description

Figure 12 shows the switch characteristics of the relay. The relay exhibits an ON-resistance that is exceptionally linear up to the knee current (I_K). Beyond I_K , the incremental resistance decreases, minimizing internal power dissipation.

In a 2 Form A relay, to turn the relay on, forward current is applied to the LED. The amount of current applied determines the amount of light produced for the photodiode array.

This photodiode array develops a drive voltage for both NMOS switch outputs. For high-temperature or high-load current operations, more LED current is required.

For high-frequency applications, the LH1514 must be wired as shown in the Figure 15 application diagram to minimize transmission crosstalk and bleed-through. A single LH1514 package switches a single transmit twisted pair or a single receive twisted pair. In this configuration when the SSR is turned off, the SSR carries high-frequency signals by shunting them through the SSR, thereby isolating the transformer load.

When switching alternate mark inversion (AMI) coding transmission, the most critical SSR parameter is dv/dt bleed-through. This bleed-through is a result of the rise and fall time slew rates of the 3.0 V AMI pulses. The test circuit in Figure 13 illustrates these bleed-through glitches. It is important to recognize that the transmission limitations of the LH1514 are bleed-through related and not frequency related. The maximum frequency the LH1514 SSR can switch will be determined by the pulse rise and fall times and the sensitivity of the receive electronics to the resultant bleed-through.

At data rates above 2.0 Mbits/s, the 50 pF pole-to-pole capacitance of the LH1514 should be considered when analyzing the load match to the transmission line. Please refer to the *T1 Switching with the LH1514 SSR* Application Note for further information on load-matching and off-state blocking.

Test Circuit

Figure 13. Off-state Bleed-through

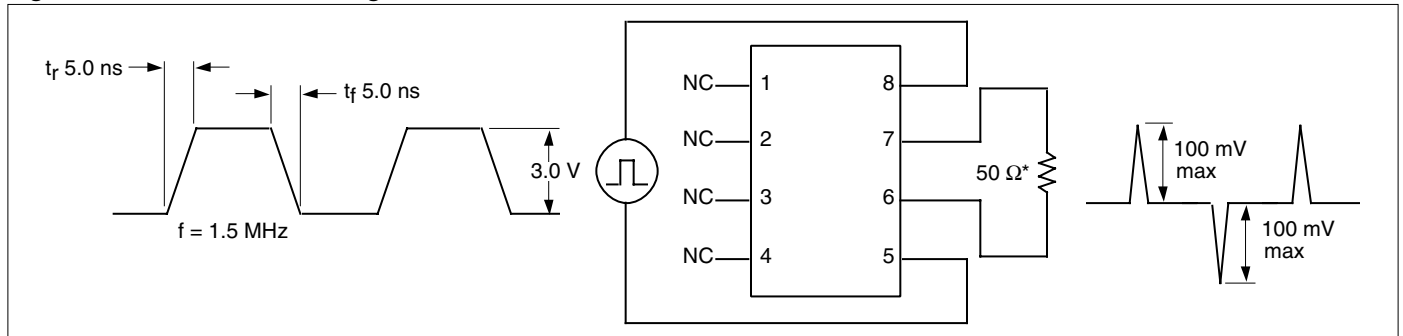

* 50 Ω load is derived from T1 applications where a 100 Ω load is paralleled with a 100 Ω line.

Figure 11. Pin Diagram and Pin Outs

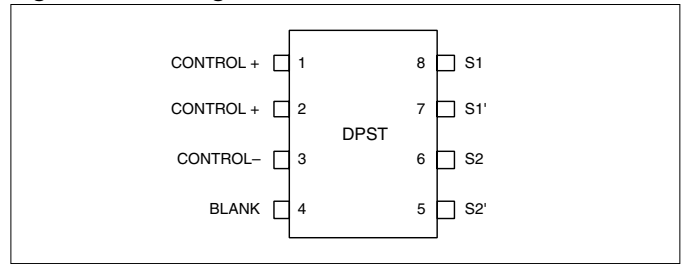
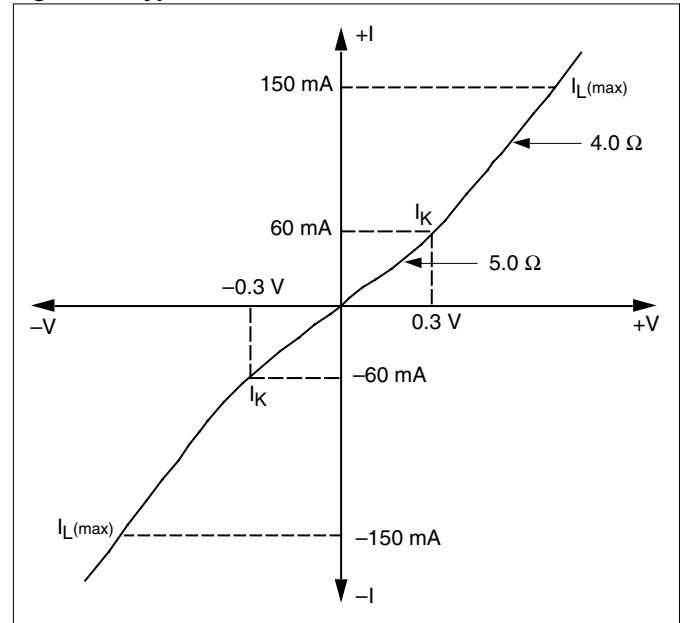

Figure 12. Typical ON Characteristics



Applications

Figure 14. Protection Switching Application: T1 Interface Operating; Spare in Test Loopback Mode

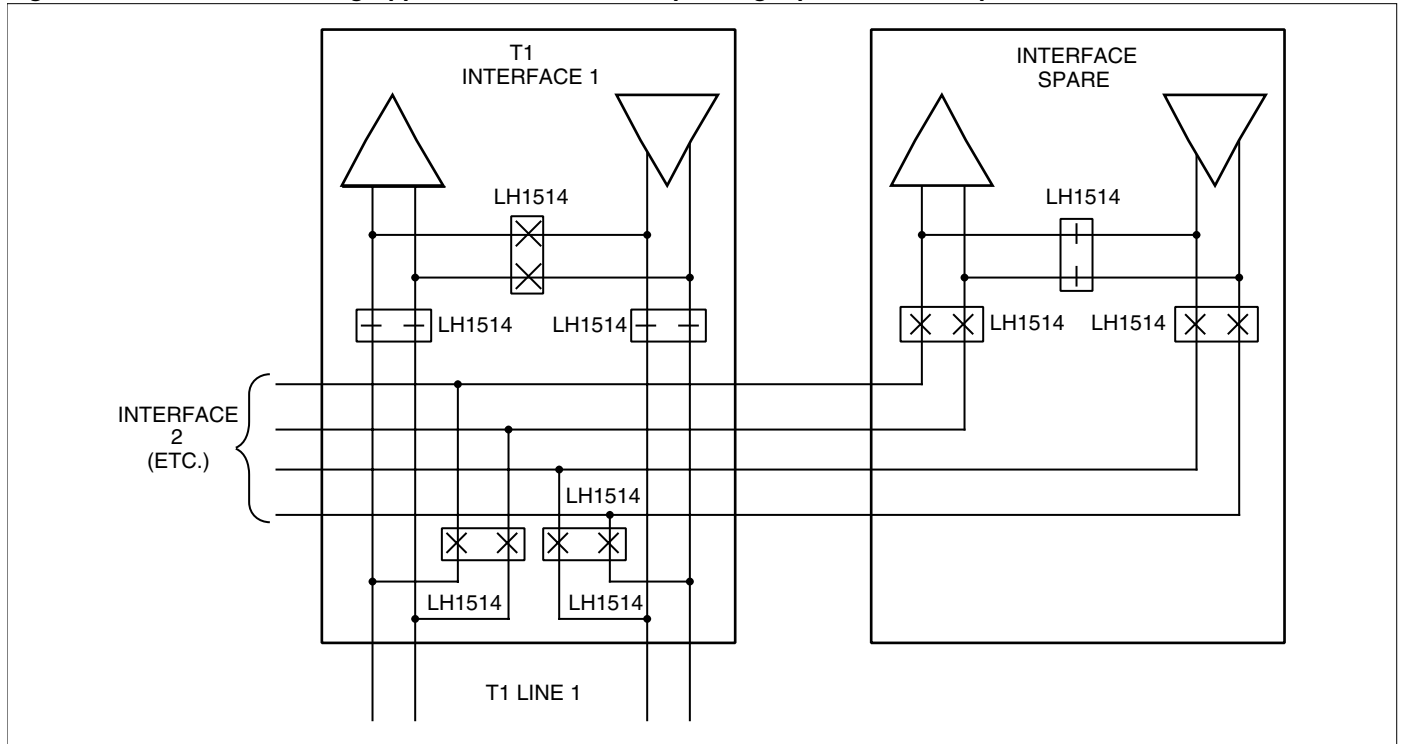

Figure 15. T1 Multiplexer Receive Data (Interface 1, Operating) Features

