

Rotary Switch 6-position Horizontal Type

SRBM Series



Pulse switching (20 pulses) model available in same figure.

- Detector
- Push
- Slide
- Rotary**
- Encoders
- Power
- Dual-in-line Package Type
- TACT Switch™
- Custom-Products

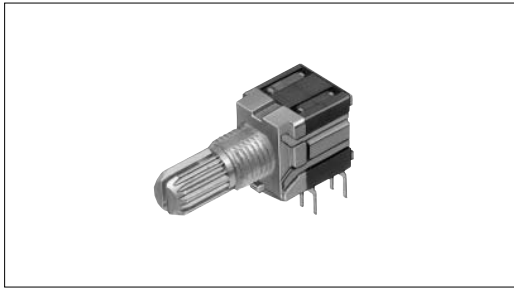

Typical Specifications

Items	Specifications	
	Rotary switch	Pulse switch
Rating(max.)(min.) (Resistive load)	0.1A 16V DC/50μA 3V DC	
Contact resistance (Initial/After operating life)	50m max./150m max.	
Rotational torque	40 ± 20 mN·m	15 ± 7 mN·m
Operating life	Without load	10,000cycles / 30,000cycles
	With load	10,000cycles(0.1A 16V DC)

Product Line

Number of wafers	Poles	Positions	Changeover angle	Changeover timing	Actuator configuration	Actuator length(mm)	Minimum order unit(pcs.)	Product No.	Drawing No.
1	2	2	30 ± 3 °	Non shorting	18-tooth serration	L=15	1,600	SRBM120700	1
					Flat			SRBM121300	
		3			18-tooth serration	L=20	1,200	SRBM131300	
					18-tooth serration	L=15	1,600	SRBM131400	
		4			18-tooth serration	L=20	1,200	SRBM140700	
					Flat	L=20	1,200	SRBM140800	
	1	5	6	18 ± 3 °		18-tooth serration	L=15	1,600	SRBM149501
						Flat			SRBM150500
		6	18-tooth serration			L=15	1,600	SRBM154002	
			Flat					SRBM160700	
		20 pulses	18-tooth serration			L=15	1,200	SRBM1L0800	
			Flat					SRBM1L1400	

Notes

1. Products other than those listed in the above chart are also available. Please contact us for details.
2. All the axis are die casting shafts.
3. Please place purchase orders per minimum order unit(integer).

Refer to P.171 for shaft configurations.
Refer to P.173 for attached parts.

Dimensions
Single-shaft Type

Unit:mm

No.	Style	PC board mounting hole dimensions (Viewed from the direction A)
1	<p>Rotary switch</p>	
2	<p>Pulse switch</p>	

- Detector
- Push
- Slide
- Rotary
- Encoders
- Power
- Dual-in-line Package Type
- TACT Switch™
- Custom-Products

Pulse Switch Circuit Diagram

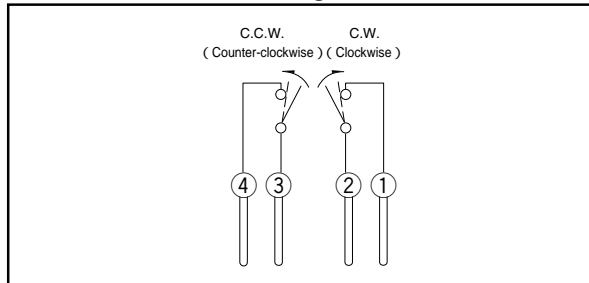

C.W. : ON during changeover only
C.C.W. : ON during changeover only

Rotary Switch Circuit Diagram (Viewed from Direction A of Below Diagram)

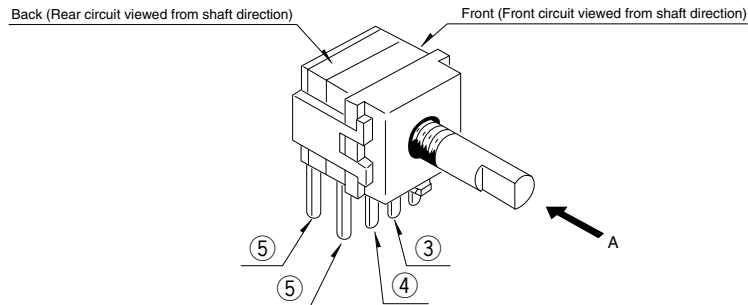

Rotary Switch 6-position Horizontal Type | SRBM Series

- Detector
- Push
- Slide
- Rotary**
- Encoders
- Power
- Dual-in-line Package Type
- TACT Switch™
- Custom-Products

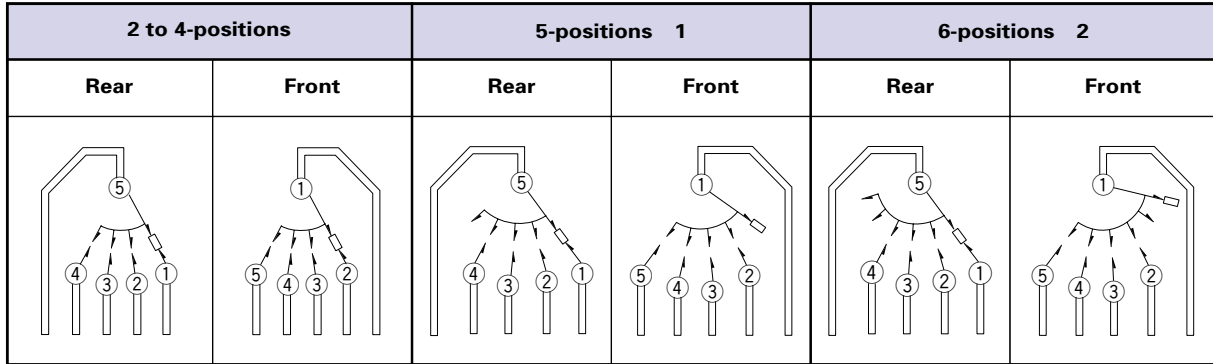

1: Circuit steps are positions 2 to 5 at front and positions 1 to 4 at rear.
 2: Circuit steps are positions 3 to 6 at front and positions 1 to 4 at rear.
 For above 1 and 2: External wiring to common terminal is required.







Notes

1. For positions 2 to 4, 1 section consists of 2-poles.
2. For positions 5 and 6, 1 section consists of 1-pole.

Dummy Terminals

Number of positions	2	3	4	5	6
Front			—	—	—
Rear			—	—	—

List of Varieties

Series		SRBD	SRBQ		SRRM	SRBV	SRBM		SRRN					
			Insertion	Reflow type			Rotary	Pulse						
Photo														
Outline specifications	Step angle	36°	40 ± 3°		30 ± 3°			18 ± 3°	30 ± 3°					
	Number of poles	1		1 2 3 4	1	1 2	2 3 4							
Dimensions (mm)		W	11.4		—	16.2	12.5		—					
		D	12.4			18.5	10							
		H	3.5			7.5	11.5							
Operating temperature range		-25 to +85		-10 to +60		-40 to +85		-10 to +60						
Rating(max)/(min) (Resistive load)		1mA 5V DC 50μA 3V DC		0.1A 16V DC 50μA 3V DC		0.25A 30V DC 50μA 3V DC		0.3A 16V DC 50μA 3V DC		0.1A 16V DC 50μA 3V DC		0.15A 12V DC 50μA 3V DC		
Electrical performance	Initial contact resistance		100M min. 100V DC		100M min. 500V DC		100M min. 100V DC		100M min. 500V DC					
	Insulation resistance		100V AC for 1minute		500V AC for 1minute		100V AC for 1minute		500V AC for 1minute					
	Voltage proof		3N for 1minute		5N for 1minute		10N for 1minute		5N for 1minute					
Mechanical performance	Actuator strength	Rotational direction	—		1N·m		0.6N·m		0.5N·m		1N·m			
		Push direction	50N		20N		100N							
	Wobble of actuator		Load at the tip of shaft SRRM : 5N SRBV, SRBQ : 1N			The below table shows for SRBQ (Unit : mm)			The below table shows for SRBV (Unit : mm)			Measuring position from mounting surface	Shaft wobble (max. value)	Applicable mounting dimension
		(Unit : mm)			Distance from mounting surface to the tip of shaft			Shaft wobble (max. value)			Load at the tip of shaft : 5N			
		Measuring position from mounting surface	Shaft wobble (max. value)	Applicable mounting dimension	below 5			0.5 max.			10mm	0.17 mm	15 mm	
		10	0.17	15	above 5 and below 10			0.9 max.			15mm	0.25 mm	20 mm	
		15	0.25	20	above 10 and below 15			1.2 max.			10	0.2	15	
		15	0.3	20							15	0.3	20	
Durability	Operating life without load		10,000cycles 250m max.		10,000cycles 100m max.		10,000cycles 40m max.		10,000cycles 100m max.		30,000cycles 100m max.		10,000cycles 70m max.	
	Operating life with load Load : (at rated load)		10,000cycles 250m max.		10,000cycles 100m max.		10,000cycles 60m max.		10,000cycles 150m max.				10,000cycles 100m max.	
Environmental performance	Cold		-40 ± 2 for 500h		-20 ± 2 for 96h									
	Dry heat		85 ± 2 for 500h		85 ± 2 for 96h									
	Damp heat		60 ± 2 , 90 to 95%RH for 500h		40 ± 2 , 90 to 95%RH for 96h									
Soldering	Manual soldering		—		350 ± 10 3 ± 1s		350 ± 5 3s max.		350 ± 10 , 3 ± 1s					
	Dip soldering		—		260 ± 5 5 ± 1s		—		260 ± 5 10 ± 1s		260 ± 3 5s max.		260 ± 5 10 ± 1s	
	Reflow soldering		Please see P.172		—									
Page		158		160		167		165		162		169		

Detector

Push

Slide

Rotary

Encoders

Power

Dual-in-line
Package Type

TACT Switch™

Custom-
Products

Rotary Switches Shaft Style	171
Rotary Switches Soldering Conditions	172
Rotary Switches Attached Parts	173
Rotary Switches Cautions	174

Shaft Configurations

18-tooth Serration Shaft

The shaft shows the position in which it is turned fully counterclockwise.

Cutting Shaft

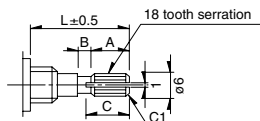

Die Casting Shaft

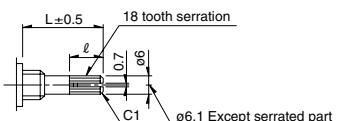

Unit:mm

Shaft length L	A	B	C
15	6	1	7
20	10	2	11

Unit:mm

Shaft length L	l
15	8
20	12

Details About Serration

- (1) The mold dimensions of standard serration and the dimensions of test jigs are as shown in the figure at left.
- (2) Position of the serration bottom
When the shaft is turned fully counterclockwise, the position of the serration bottom is on the AA line.
- (3) Slitting angle
The slitting angle (position) is not specified.

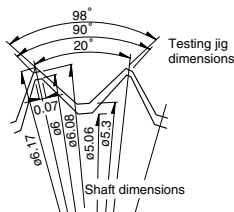

Round Shaft

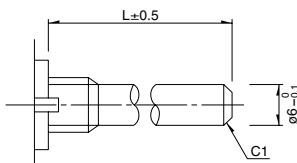

Round Shaft with Groove

The shaft shows the position in which it is turned fully counterclockwise.

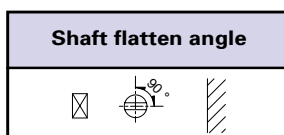
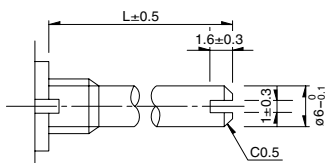

Flat Shaft

The shaft shows the position in which it is turned fully counterclockwise.

Cutting Shaft

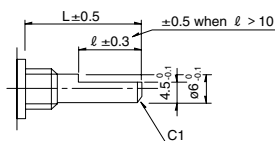

Die Casting Shaft

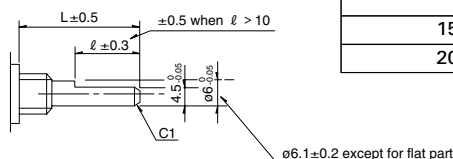

Unit:mm

Shaft length L	l
15	7
20	12

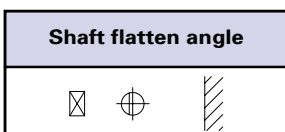

Note

SRBM Series are based on (printed terminal direction). SRRM, SRRN, SRBV Series are based on (panel lug).

Detector

Push

Slide

Rotary

Encoders

Power

Dual-in-line
Package Type

TACT Switch™

Custom-
Products

Attached Parts

The following parts are included with the product.

SRRM, SRBV

Unit:mm

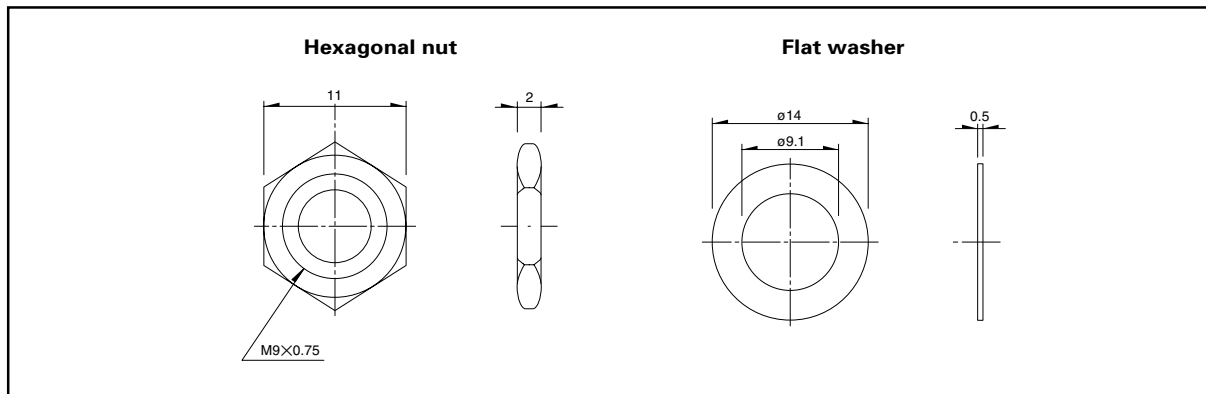

SRBM, SRRN

Unit:mm

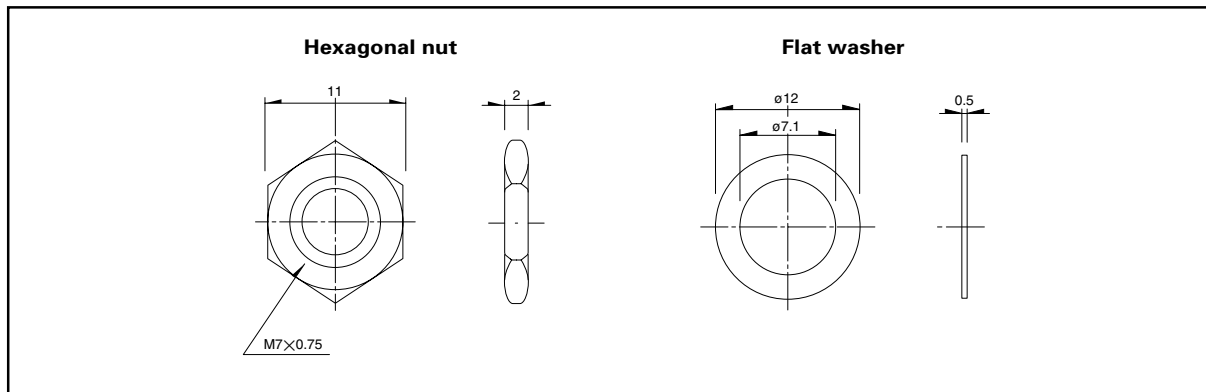

Detector

Push

Slide

Rotary

Encoders

Power

Dual-in-line
Package Type

TACT Switch™

Custom-
Products