

Pushbutton Switches, Tiny, Straight or Right Angle, Single or Dual Actuators

SEE PAGE D6 FOR PRODUCT SPECIFICATIONS

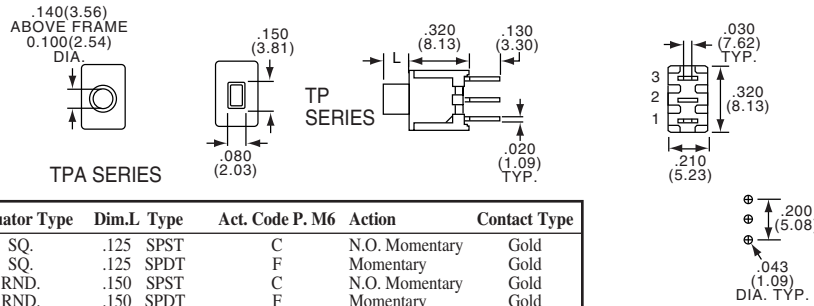

SPST/SPDT



TP11CGPC0



TPA11CGPC0

Model	Actuator Type	Dim.L	Type	Act. Code P. M6	Action	Contact Type
TP11CGPC(*)	SQ.	.125	SPST	C	N.O. Momentary	Gold
TP11FGPC(*)	SQ.	.125	SPDT	F	Momentary	Gold
TPA11CGPC(*)	RND.	.150	SPST	C	N.O. Momentary	Gold
TPA11FGPC(*)	RND.	.150	SPDT	F	Momentary	Gold

(*) Specify button color by adding suffix number: (0) Black, (2) Red.
Note: No center terminal on "C" action switch.

D
TP/TPA Series

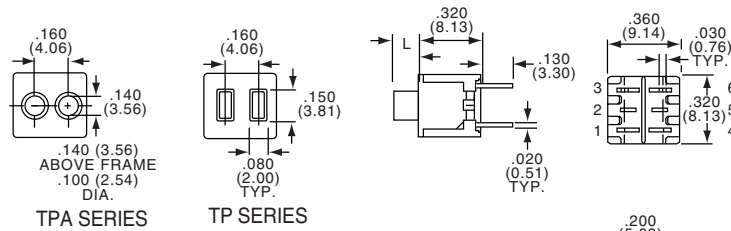

SPST/SPDT (DUAL)



TP21CCGPC0

Model	Actuator Type	Dim.L	Type	Act. Code P. M6	Action	Contact Type
TP21CCGPC(*)	SQ.	.125	2xSPST	C	N.O. Momentary	Gold
TPA21CCGPC(*)	RND.	.150	2xSPST	C	N.O. Momentary	Gold
TPA21FFGPC(*)	RND.	.150	2xSPDT	F	Momentary	Gold

(*) Specify button color by adding suffix number: (0) Black, (2) Red.
Note: No center terminal on "C" action switch.

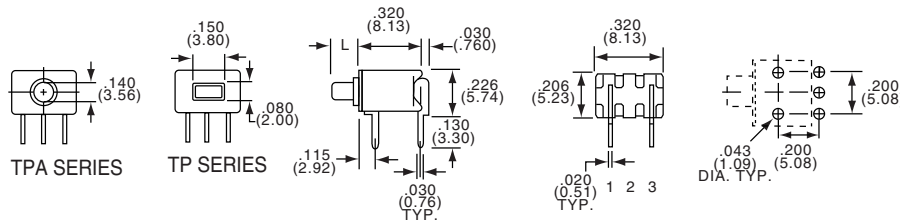
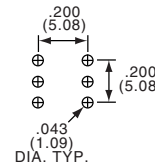

SPST/SPDT



TPA11CGRA



TP11CGRA

Model	Actuator Type	Dim.L	Type	Act. Code P. M6	Action	Contact Type
TP11CGRA(*)	SQ.	.125	SPST	C	N.O. Momentary	Gold
TP11FGRA(*)	SQ.	.125	SPDT	F	Momentary	Gold
TPA11CGRA(*)	RND.	.150	SPST	C	N.O. Momentary	Gold
TPA11FGRA(*)	RND.	.150	SPDT	F	Momentary	Gold

(*) Specify button color by adding suffix number: (0) Black, (2) Red.
Note: No center terminal on "C" action switch.

Pushbutton Switches, Tiny, Right Angle, Single or Dual Actuators

SEE PAGE D6 FOR PRODUCT SPECIFICATIONS

* Refer to Page D6 for Additional Options *
TP/TPA Series



TP21CCGRA0

SPST/SPDT (DUAL)
DPST

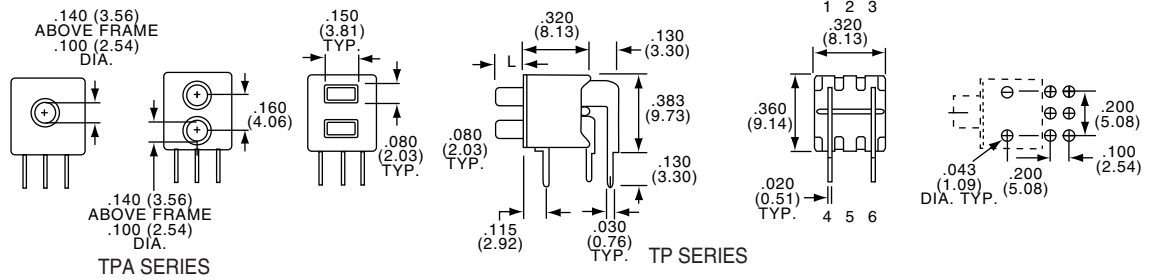

Model	Actuator Type	Dim.L	Type	Act. Code P. M6	Action	Contact Type
TP21CCGRA(*)	SQ.	.125	2xSPST	C	N.O. Momentary	Gold
TP21FFGRA(*)	SQ.	.125	2xSPDT	F	Momentary	Gold
TPA21MGRA(*)	RND.	.150	DPST	M	N.O. Momentary	Gold
TPA21CCGRA(*)	RND.	.150	2xSPST	C	N.O. Momentary	Gold
TPA21FFGRA(*)	RND.	.150	2xSPDT	F	Momentary	Gold

(*) Specify button color by adding suffix number: (0) Black, (2) Red.
Note: No center terminal on "C" or "M" action switch.

Pushbutton Switches, Tiny, Straight or Right Angle, Unthreaded or 10-48 Bushing

SPST/SPDT



TPB11CGPC



TPC11FGPC

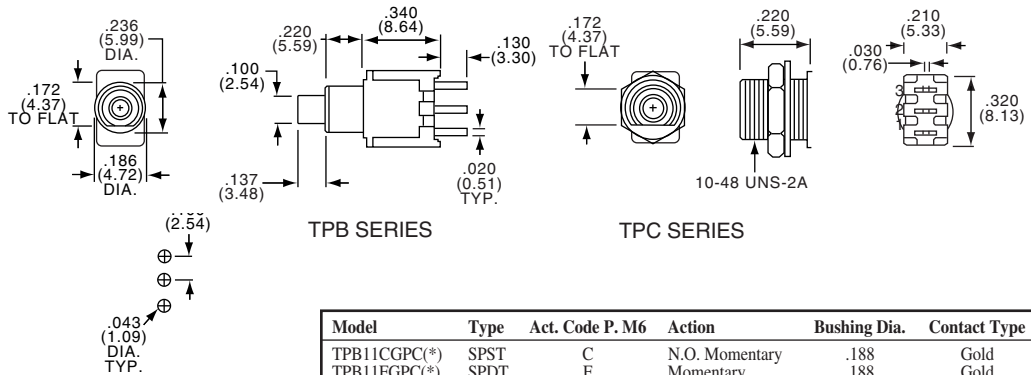

Model	Type	Act. Code P. M6	Action	Bushing Dia.	Contact Type
TPB11CGPC(*)	SPST	C	N.O. Momentary	.188	Gold
TPB11FGPC(*)	SPDT	F	Momentary	.188	Gold
TPC11CGPC(*)	SPST	C	N.O. Momentary	10-48	Gold
TPC11FGPC(*)	SPDT	F	Momentary	10-48	Gold

(*) Specify button color by adding suffix number: (0) Black, (2) Red.
Note: No center terminal on "C" action switch.

DPST/DPDT



TPB11CGRA



TPC11CGRA

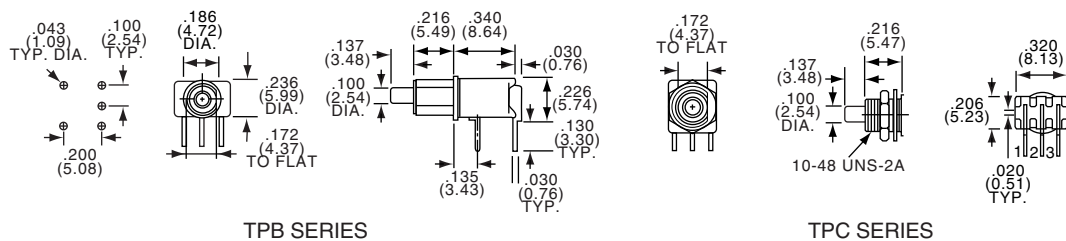

Model	Type	Act. Code P. M6	Action	Bushing Dia.	Contact Type
TPB11CGRA(*)	SPST	C	N.O. Momentary	.188	Gold
TPB11FGRA(*)	SPDT	F	Momentary	.188	Gold
TPC11CGRA(*)	SPST	C	N.O. Momentary	10-48	Gold
TPC11FGRA(*)	SPDT	F	Momentary	10-48	Gold

(*) Specify button color by adding suffix number: (0) Black, (2) Red.
Note: No center terminal on "C" action switch.

Pushbutton Switches, Tiny, Straight or Right Angle, Unthreaded or 10-48 Bushing

SEE PAGE D6 FOR PRODUCT SPECIFICATIONS
DPST/DPDT

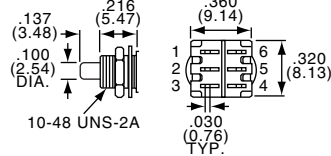
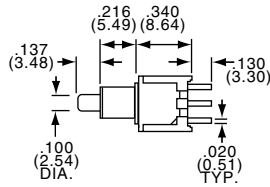
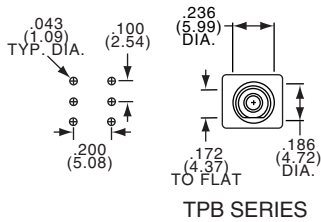

TPB21MGPC



TPC21RGPC

Model	Type	Act. Code P. M6	Action	Bushing Dia.	Contact Type
TPB21MGPC(*)	DPST	M	N.O. Momentary	.188	Gold
TPB21RGPC(*)	DPDT	R	Momentary	.188	Gold
TPC21MGPC(*)	DPST	M	N.O. Momentary	10-48	Gold
TPC21RGPC(*)	DPDT	R	Momentary	10-48	Gold

(*) Specify button color by adding suffix number: (0) Black, (2) Red.
Note: No center terminal on "M" action switch.

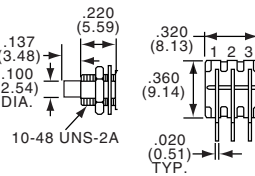
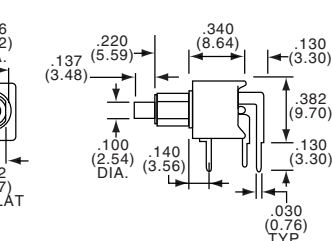
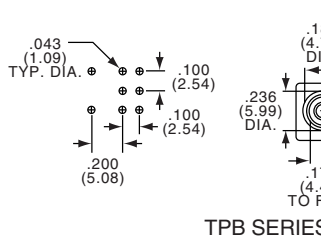

DPST/DPDT



TPC21MGRA

Model	Type	Act. Code P. M6	Action	Bushing Dia.	Contact Type
TPB21MGRA(*)	DPST	M	N.O. Momentary	.188	Gold
TPB21RGRA(*)	DPDT	R	Momentary	.188	Gold
TPC21MGRA(*)	DPST	M	N.O. Momentary	10-48	Gold
TPC21RGRA(*)	DPDT	R	Momentary	10-48	Gold

(*) Specify button color by adding suffix number: (0) Black, (2) Red.
Note: No center terminal on "M" action switch.

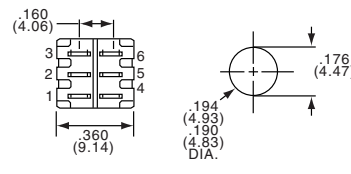
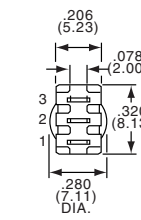
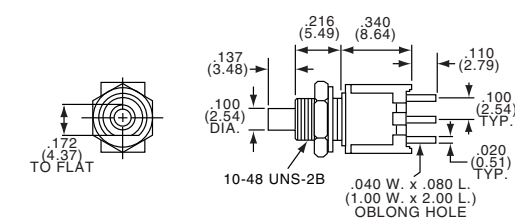

1 & 2 POLE



TPC23M



TPC13C

Model	Type	Act. Code P. M6	Action	Contact Type
TPC13C(*)	SPST	C	N.O. Momentary	Silver
TPC13F(*)	SPDT	F	Momentary	Silver
TPC23M(*)	DPST	M	N.O. Momentary	Silver
TPC23R(*)	DPDT	R	Momentary	Silver

(*) Specify button color by adding suffix number: (0) Black, (2) Red.
Note: No center terminal on "C" or "M" action switches.

Pushbutton Switches, Tiny, Straight or Right Angle, Flush Actuator

SEE PAGE D6 FOR PRODUCT SPECIFICATIONS

SPST/SPDT
Wire Lugs 10-48 Bushing



TPCF13C

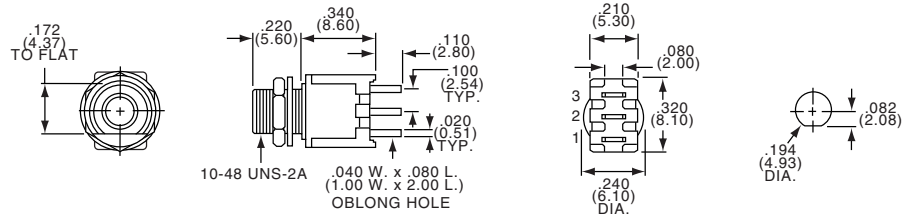

Model	Silver Contacts	Type	Act. Code P. M6	Action	Bushing Type
TPCF13C(*)		SPST	C	N.O. Momentary	Threaded
TPCF13F(*)		SPDT	F	Momentary	Threaded

(*) Specify button color by adding suffix numbers: (0) Black, (2) Red.
Note: No center terminal on "C" action switch.

SPST/SPDT
PC 10-48 Bushing



TPBF11FGPC



TPCF11CGPC

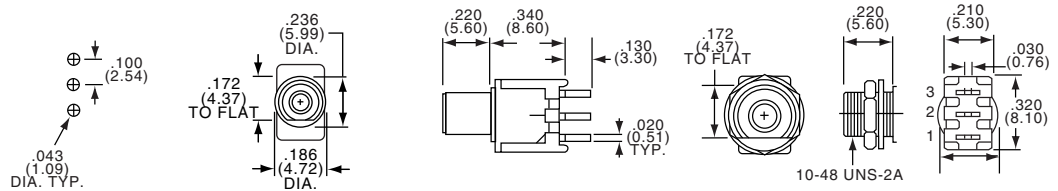

TPB SERIES

TPC SERIES

Model	Gold Contacts	Type	Act. Code P. M6	Action	Bushing Type
TPBF11CGPC(*)		SPST	C	N.O. Momentary	Unthreaded
TPBF11FGPC(*)		SPDT	F	Momentary	Unthreaded
TPCF11CGPC(*)		SPST	C	N.O. Momentary	Threaded
TPCF11FGPC(*)		SPDT	F	Momentary	Threaded

(*) Specify button color by adding suffix numbers: (0) Black, (2) Red.
Note: No center terminal on "C" action switch.

SPST/SPDT
RA 10-48 Bushing



TPBF11CGRA

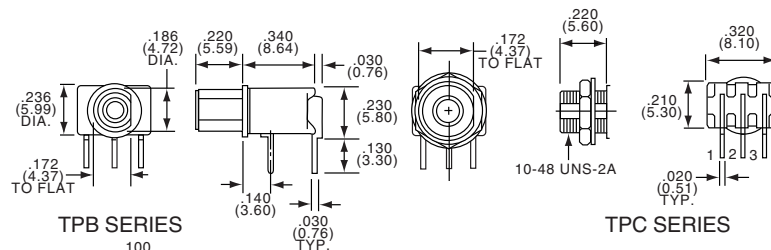

TPB SERIES

TPC SERIES

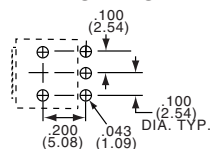

Model	Gold Contacts	Type	Act. Code P. M6	Action	Bushing Type
TPBF11CGRA(*)		SPST	C	N.O. Momentary	Unthreaded
TPBF11FGRA(*)		SPDT	F	Momentary	Unthreaded
TPCF11CGRA(*)		SPST	C	N.O. Momentary	Threaded
TPCF11FGRA(*)		SPDT	F	Momentary	Threaded

(*) Specify button color by adding suffix numbers: (0) Black, (2) Red.
Note: No center terminal on "C" action switch.

Pushbutton Switches, Tiny, Vertical Right Angle, Unthreaded or 10-48 Bushing

SEE PAGE D6 FOR PRODUCT SPECIFICATIONS

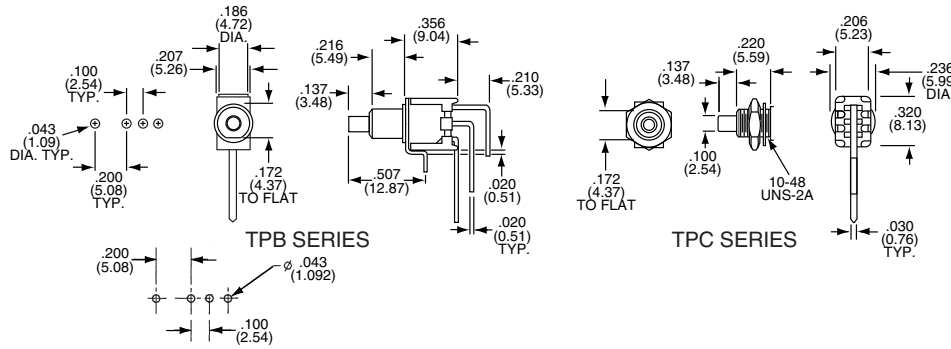

TPB11FGVRA

Model	Type	Act. Code P. M6	Action	Contact Type
TPB11CGVRA(*)	SPST	C	N.O. Momentary	Gold
TPB11FGVRA(*)	SPDT	F	Momentary	Gold
TPC11CGVRA(*)	SPST	C	N.O. Momentary	Gold
TPC11FGVRA(*)	SPDT	F	Momentary	Gold

(*) Specify button color by adding suffix number: (0) Black, (2) Red.
 Note: No center terminal on "C" action switches.

D
TP Series

Pushbutton Switches, Tiny, Vertical, Unthreaded or 1/4-40 Bushing

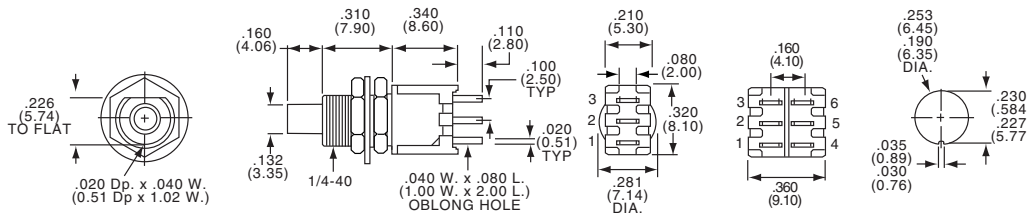

TPF23M

TPF13C

Model	Type	Act. Code P. M6	Action	Contact Type
TPF13C(*)	SPST	C	N.O. Momentary	Silver
TPF13F(*)	SPDT	F	Momentary	Silver
TPF23M(*)	DPST	M	N.O. Momentary	Silver
TPF23R(*)	DPDT	R	Momentary	Silver

(*) Specify button color by adding suffix number: (0) Black, (2) Red.
 Note: No center terminal on "C" or "M" action switches.

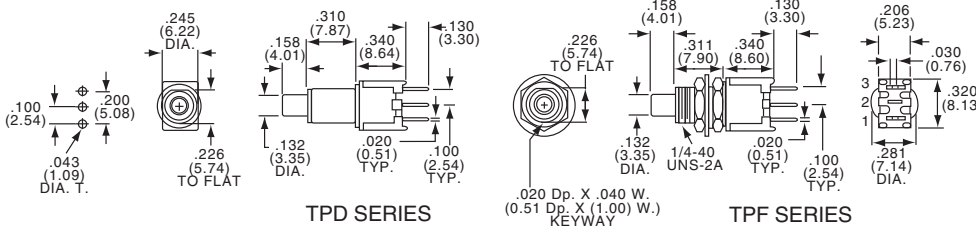

SPST/SPDT



TPD11CGPC

Model	Type	Act. Code P. M6	Action	Bushing Dia.	Contact Type
TPD11CGPC(*)	SPST	C	N.O. Momentary	.250	Gold
TPD11FGPC(*)	SPDT	F	Momentary	.250	Gold
TPF11CGPC(*)	SPST	C	N.O. Momentary	1/4-40	Gold
TPF11FGPC(*)	SPDT	F	Momentary	1/4-40	Gold

(*) Specify button color by adding suffix number: (0) Black, (2) Red.
 NOTE: No center terminal on "C" action switch.

Pushbutton Switches, Tiny, Vertical or Right Angle, Unthreaded or 1/4-40 Bushing

SEE PAGE D6 FOR PRODUCT SPECIFICATIONS

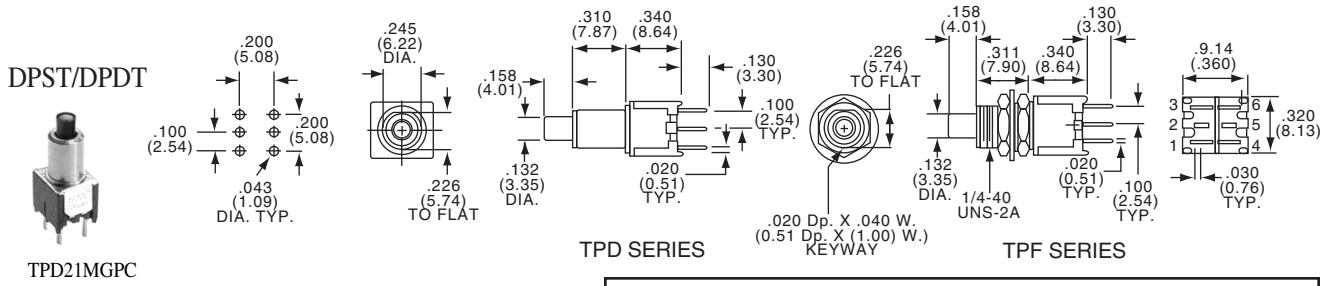

Model	Type	Act. Code	P. M6	Action	Bushing Dia.	Contact Type
TPD21MGPC(*)	DPST	M		N.O. Momentary	.250	Gold
TPD21RGPC(*)	DPDT	R		Momentary	.250	Gold
TPF21MGPC(*)	DPST	M		N.O. Momentary	1/4-40	Gold
TPF21RGPC(*)	DPDT	R		Momentary	1/4-40	Gold

(*) Specify button color by adding suffix number: (0) Black, (2) Red.
 Note: No center terminals on "M" Action switches.

D

TPD/TPF Series

SPST/SPDT

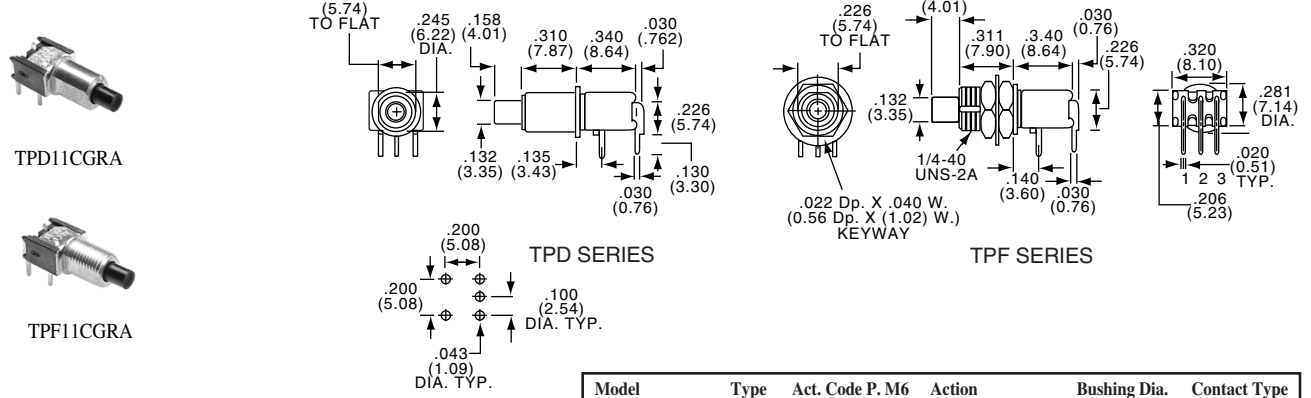

Model	Type	Act. Code	P. M6	Action	Bushing Dia.	Contact Type
TPD11CGRA(*)	SPST	C		N.O. Momentary	.250	Gold
TPD11FGRA(*)	SPDT	F		Momentary	.250	Gold
TPF11CGRA(*)	SPDT	C		N.O. Momentary	1/4-40	Gold
TPF11FGRA(*)	SPDT	F		Momentary	1/4-40	Gold

(*) Specify button color by adding suffix number: (0) Black, (2) Red.
 Note: No center terminal on "C" action switch.

DPST/DPDT

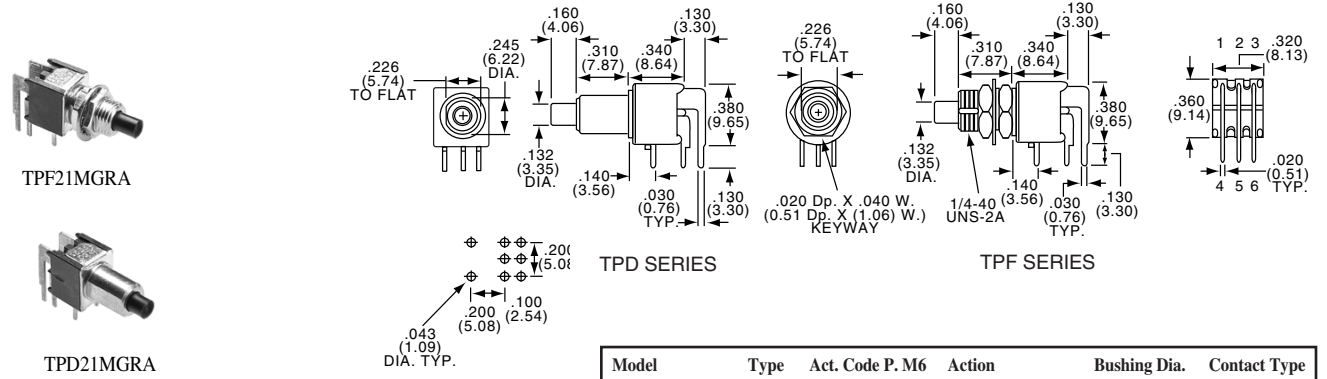

Model	Type	Act. Code	P. M6	Action	Bushing Dia.	Contact Type
TPD21MGRA(*)	DPST	M		N.O. Momentary	.250	Gold
TPD21RGRA(*)	DPDT	R		Momentary	.250	Gold
TPF21MGRA(*)	DPST	M		N.O. Momentary	1/4-40	Gold
TPF21RGRA(*)	DPDT	R		Momentary	1/4-40	Gold

(*) Specify button color by adding suffix number: (0) Black, (2) Red.
 Note: No center terminal on "M" Action switches.