

1-Watt SMD 6mm (120° Viewing Angle)

OVSPxBCR4 Series

- Robust energy-efficient design with long operating life
- Low thermal resistance
- Exceptional spatial uniformity
- Optional optics to suit application
- Available in yellow, blue, green, red and white

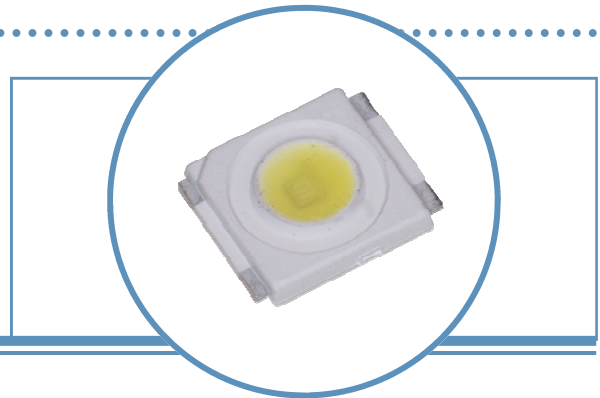

The **OVSPxBCR4 Series** is an energy-efficient packaged LED source that offers high luminance, and a long operating lifespan. These devices offer a 120° viewing angle and an ultra-low profile (1.5mm) making them highly suitable for conventional lighting and specialized applications. Optional optics are offered to suit application. Please contact OPTEK for more information.

Applications

- Automotive exterior and interior lighting
- Architectural indoor and outdoor lighting
- General lighting
- Electronic signs and signals

Part Number	Viewing Angle	Emitted Color	Typical Luminous Flux (lm)	Typical On-Axis Intensity (cd)	Lens Color
OVSPBBCR4	120°	Blue	9	3.4	Water Clear
OVSPGBCR4		Green	48	18.2	Water Clear
OVSPRBCR4		Red	26	9	Water Clear
OVSPYBCR4		Yellow	35	11.25	Water Clear
OVSPWBCR4		White	48	18	Water Clear

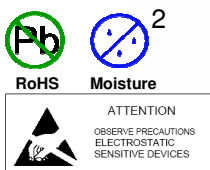
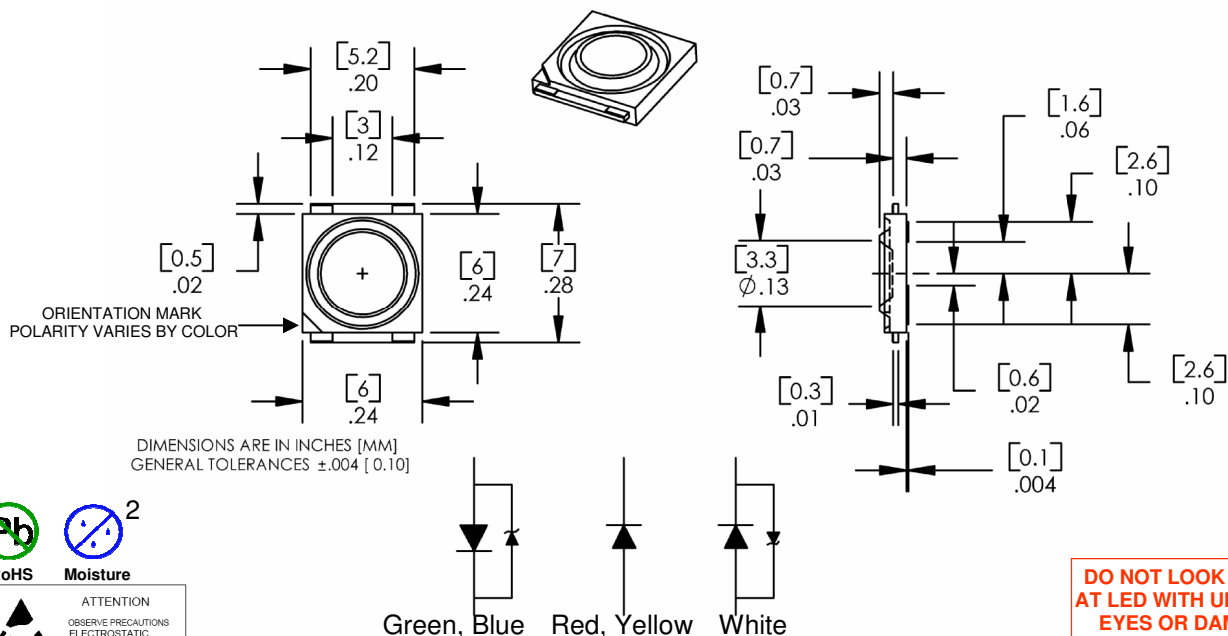

**DO NOT LOOK DIRECTLY
AT LED WITH UNSHIELDED
EYES OR DAMAGE TO
RETINA MAY OCCUR.**

OPTEK reserves the right to make changes at any time in order to improve design and to supply the best product possible.

Absolute Maximum Ratings $T_A = 25^\circ\text{C}$

	Red, Yellow	Green, Blue	White
DC Forward Current	400mA	350mA	350mA
Peak Pulsed Forward Current ¹	500mA	1000mA	1000mA
Reverse Voltage	12V	Not designed for reverse bias	
Junction Temperature ²	125 °C	120 °C	125 °C
Power Dissipation	1200mW		
Storage and Operating Temperature	-40 ° ~ +100 ° C		
ESD Threshold (HBM)	2000V		

Notes:

1. Pulse width $t_p \leq 10\mu\text{s}$, Duty cycle = 0.1
2. Thermal conductivity = 20K/W for red, yellow, green, blue; and 18K/W for white

Optical and Electrical Characteristics—Red, Yellow ($I_F = 400\text{ mA}$, $T_A = 25^\circ\text{C}$)

SYMBOL	PARAMETER	MIN	TYP	MAX	UNITS	
V_F	Forward Voltage	2.2	2.5	2.8	V	
Φ	Luminous Flux	Red	21	26	33	lm
		Yellow	27	35	42	lm
λ_D	Dominant Wavelength	Red	620	625	630	nm
		Yellow	585	587	597	nm
I_R	Reverse Current	----	100	----	μA	
$2\Theta_{1/2}$	50% Power Angle	----	120	----	deg	

Optical and Electrical Characteristics—Blue, Green ($I_F = 350\text{ mA}$, $T_A = 25^\circ\text{C}$)

SYMBOL	PARAMETER	MIN	TYP	MAX	UNITS	
V_F	Forward Voltage	----	3.6	4.0	V	
Φ	Luminous Flux	Blue	5.8	9	12	lm
		Green	38	48	60	lm
λ_D	Dominant Wavelength	Blue	464	470	476	nm
		Green	525	530	535	nm
$2\Theta_{1/2}$	50% Power Angle	----	120	----	deg	

Optical and Electrical Characteristics—White ($I_F = 350\text{ mA}$, $T_A = 25^\circ\text{C}$)

SYMBOL	PARAMETER	MIN	TYP	MAX	UNITS
V_F	Forward Voltage	----	3.6	4.0	V
Φ	Luminous Flux	39	48	63	lm
I_R	Reverse Current	----	10	----	μA
$2\Theta_{1/2}$	50% Power Angle	----	120	----	deg

OPTEK reserves the right to make changes at any time in order to improve design and to supply the best product possible.

Standard Bins

Lamps are sorted to luminous flux (Φ) and dominant wavelength (λ_D) bins shown. Orders may be filled with any or all bins contained as below.

OVSPRBCR4 (RED) ($I_F = 400$ mA)

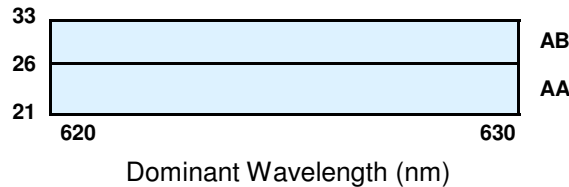

OVSPYBCR4 (YELLOW) ($I_F = 400$ mA)

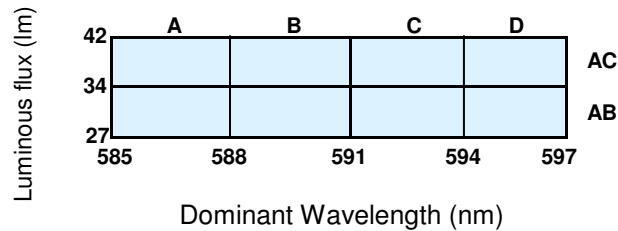

OVSPBBCR4 (BLUE) ($I_F = 350$ mA)

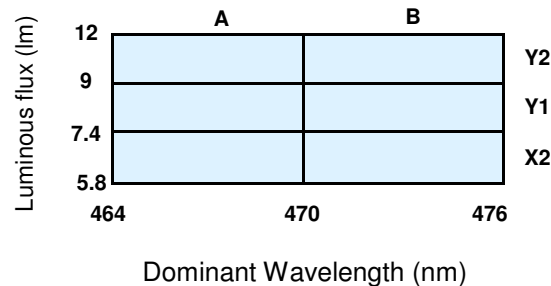

OVSPGBCR4 (GREEN) ($I_F = 350$ mA)

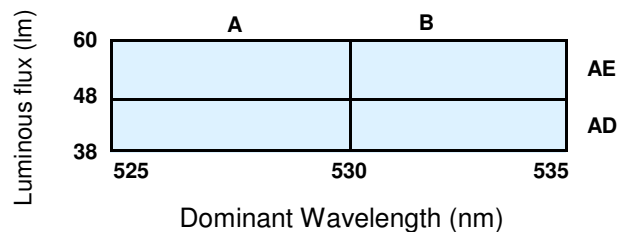

Important Notes:

1. All ranks will be included per delivery, rank ratio will be based on the chip distribution.
2. To designate luminous flux ranks, please contact OPTEK.
3. Pb content <1000PPM.

OPTEK reserves the right to make changes at any time in order to improve design and to supply the best product possible.

1-Watt SMD 6mm

OVSPxBCR4 Series

Standard Bins ($I_F = 350 \text{ mA}$) **OVSPWBCR4 (White)**

Lamps are sorted to luminous flux (Φ), chromaticity coordinates, and correlated color temperature (CCT) bins shown. Orders may be filled with any or all bins contained as below.

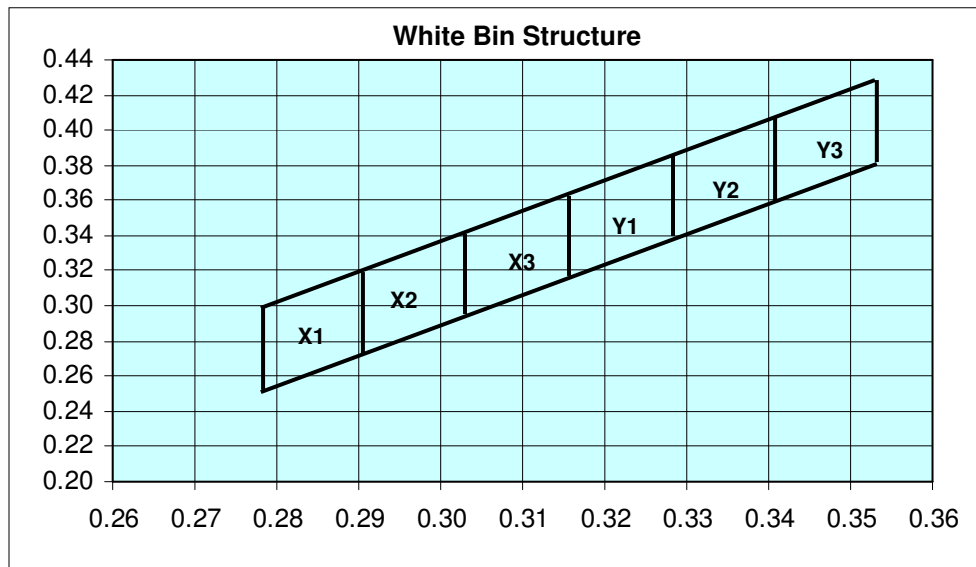

Bin		1	2	3	4
X ₁	C _x	0.2775	0.29	0.29	0.2775
	C _y	0.243	0.265	0.31	0.288
X ₂	C _x	0.29	0.3025	0.3025	0.29
	C _y	0.265	0.286	0.331	0.31
X ₃	C _x	0.3025	0.315	0.315	0.3025
	C _y	0.286	0.308	0.353	0.331
Y ₁	C _x	0.315	0.3275	0.3275	0.315
	C _y	0.308	0.33	0.375	0.353
Y ₂	C _x	0.3275	0.34	0.34	0.3275
	C _y	0.33	0.351	0.396	0.375
Y ₃	C _x	0.34	0.3525	0.3525	0.34
	C _y	0.351	0.373	0.418	0.396

Color Bin	Minimum CCT (K)	Maximum CCT (K)
Y3	4500	5000
Y2	5000	5500
Y1	5500	6000
X3	6000	7000
X2	7000	8000
X1	8000	10000

Φ	Luminous Flux (lm)	
Bin	Min	Max
AD	39	50
AE	50	63

OPTEK reserves the right to make changes at any time in order to improve design and to supply the best product possible.

Typical Electro-Optical Characteristics Curves—Red, Yellow

Relative Intensity Vs Forward Current

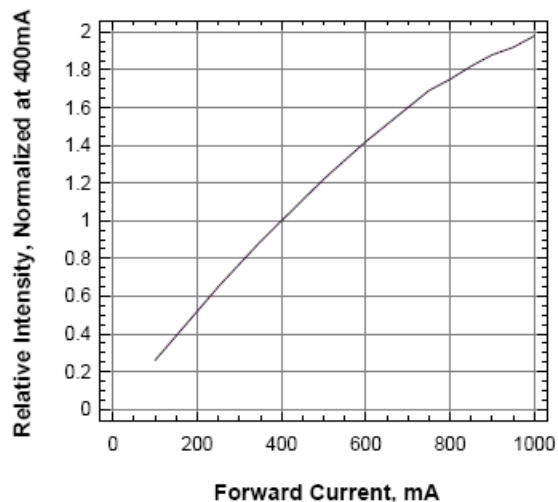

Forward Voltage Vs Forward Current

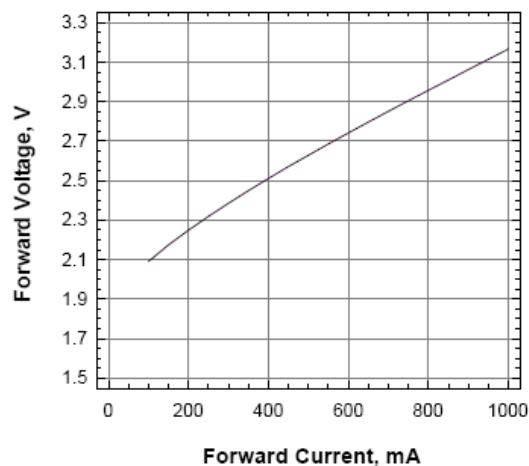

Forward Current Vs Ambient Temperature

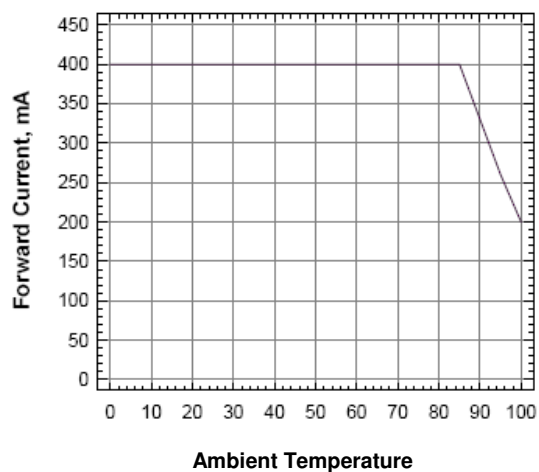

Relative Intensity Vs Wavelength

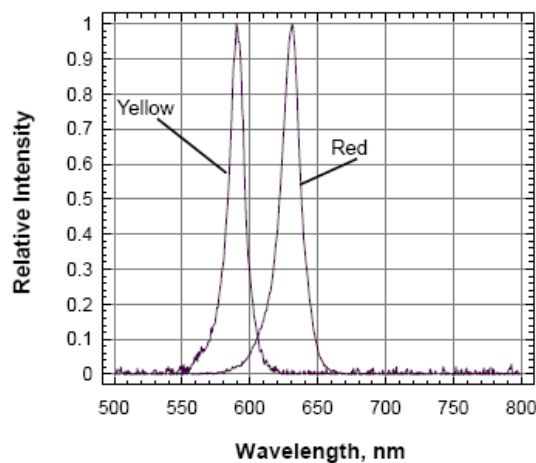

OPTEK reserves the right to make changes at any time in order to improve design and to supply the best product possible.

Typical Electro-Optical Characteristics Curves—Blue, Green

Relative Intensity Vs Forward Current

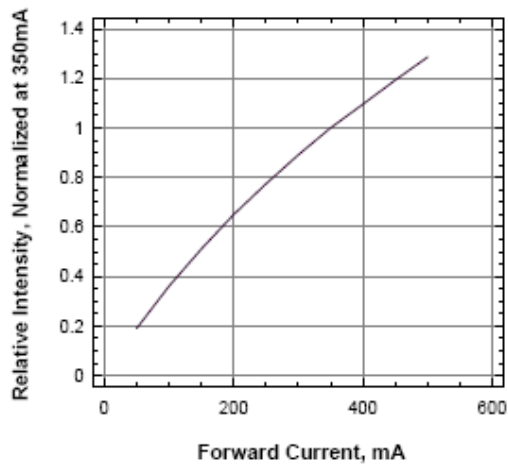

Relative Flux Vs Forward Current

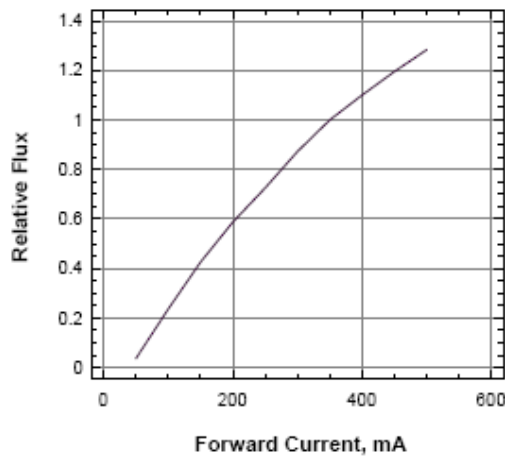

Forward Current Vs Forward Voltage

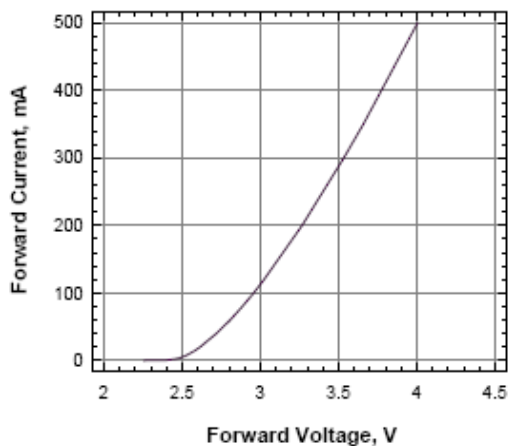

Forward Current Vs Ambient Temperature

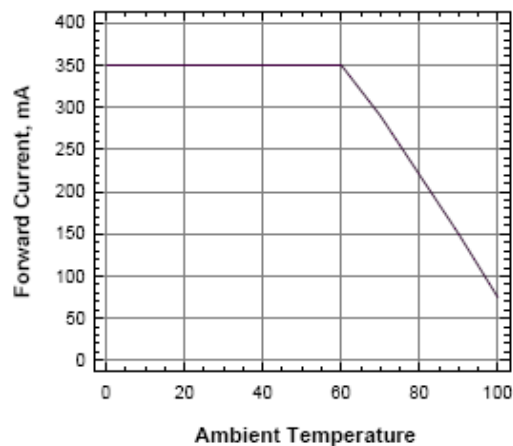

OPTEK reserves the right to make changes at any time in order to improve design and to supply the best product possible.

Typical Electro-Optical Characteristics Curves—White

Relative luminous intensity vs. forward current.

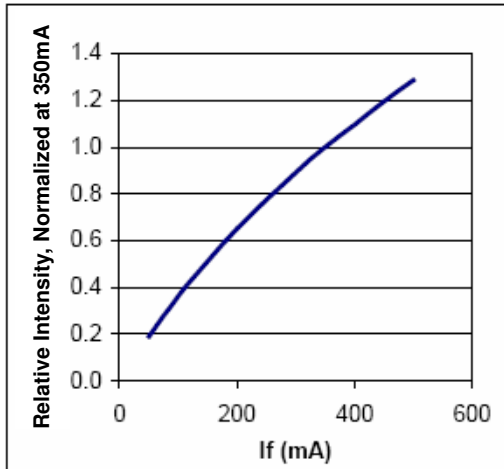

Flux vs. forward current.

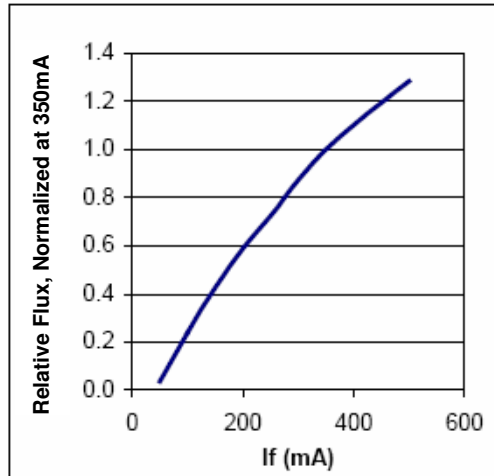

Forward current vs. forward voltage.

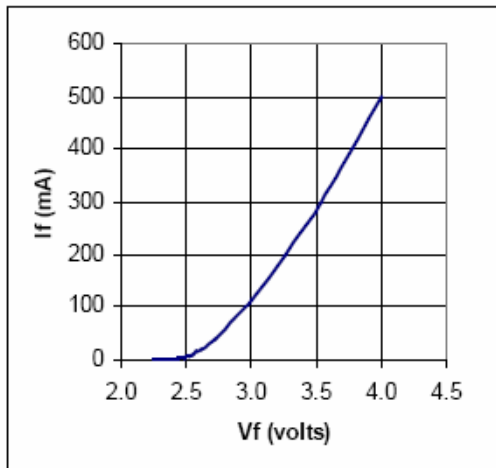

Relative Spectra Emission

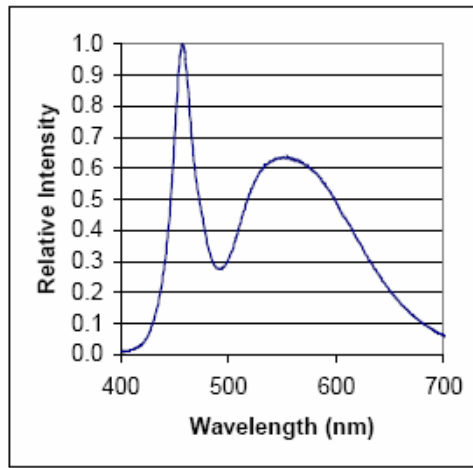

Maximum Permissible Current

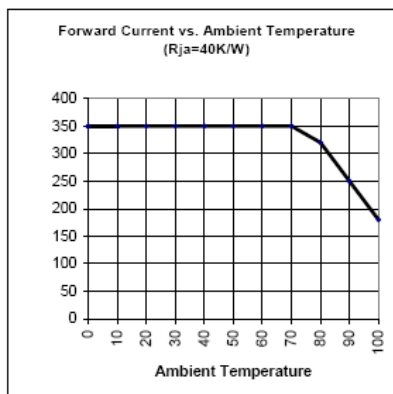

OPTEK reserves the right to make changes at any time in order to improve design and to supply the best product possible.

Radiation Pattern—All Colors

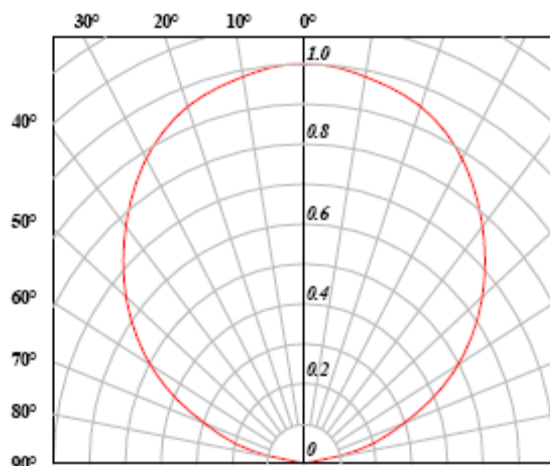

Solder Pad Design

Note: Metal core circuit board (MCPCB) is highly recommended for high density applications. Please consult sales and marketing for additional information.

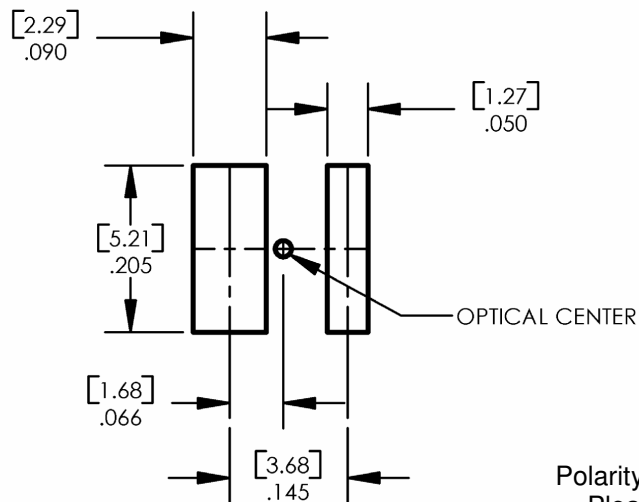

Polarity varies with color.
Please see Page 1.

OPTEK reserves the right to make changes at any time in order to improve design and to supply the best product possible.

Recommended Sn-Pb IR-Reflow Soldering Profile.

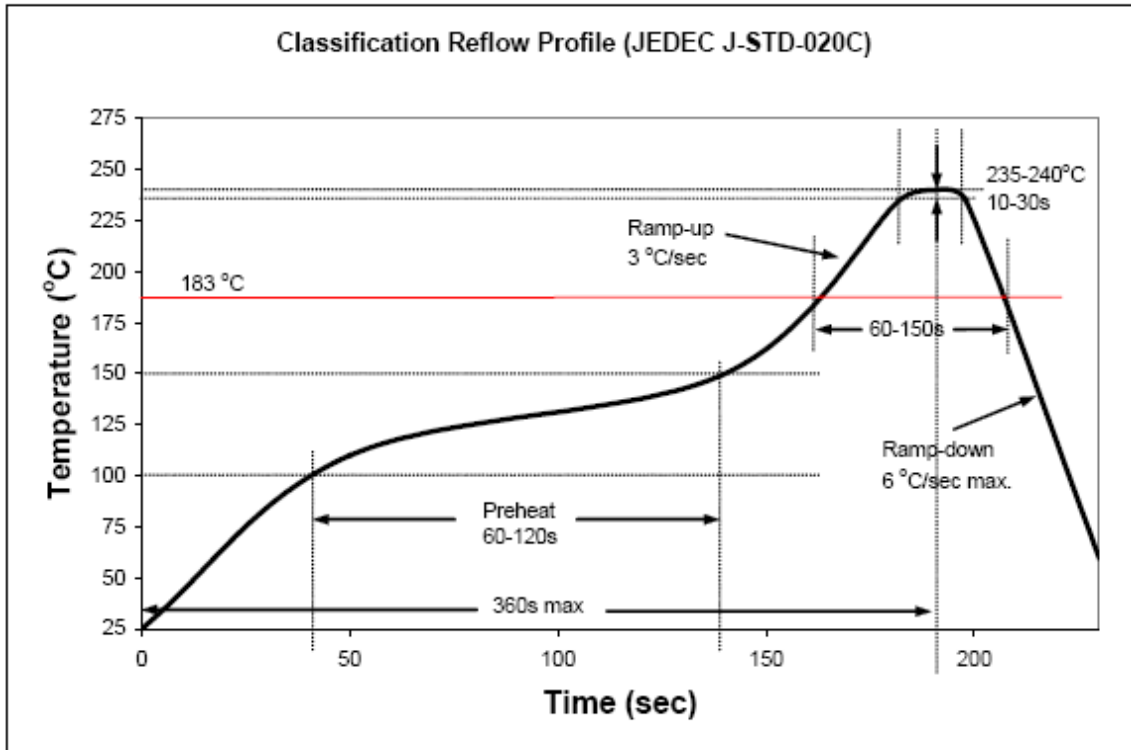

Recommended Pb Free IR-Reflow Soldering Profile.

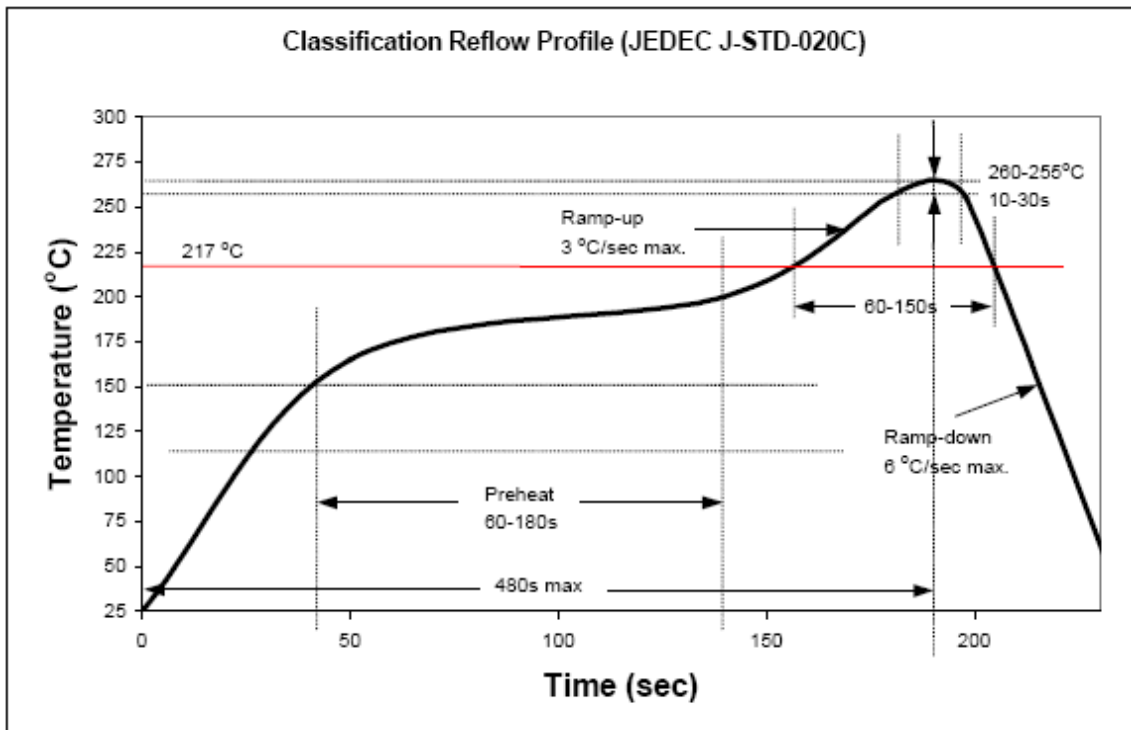

OPTEK reserves the right to make changes at any time in order to improve design and to supply the best product possible.

1-Watt SMD 6mm OVSPxBCR4 Series

Taping and Orientation
Loaded quantity 2000 pieces per reel

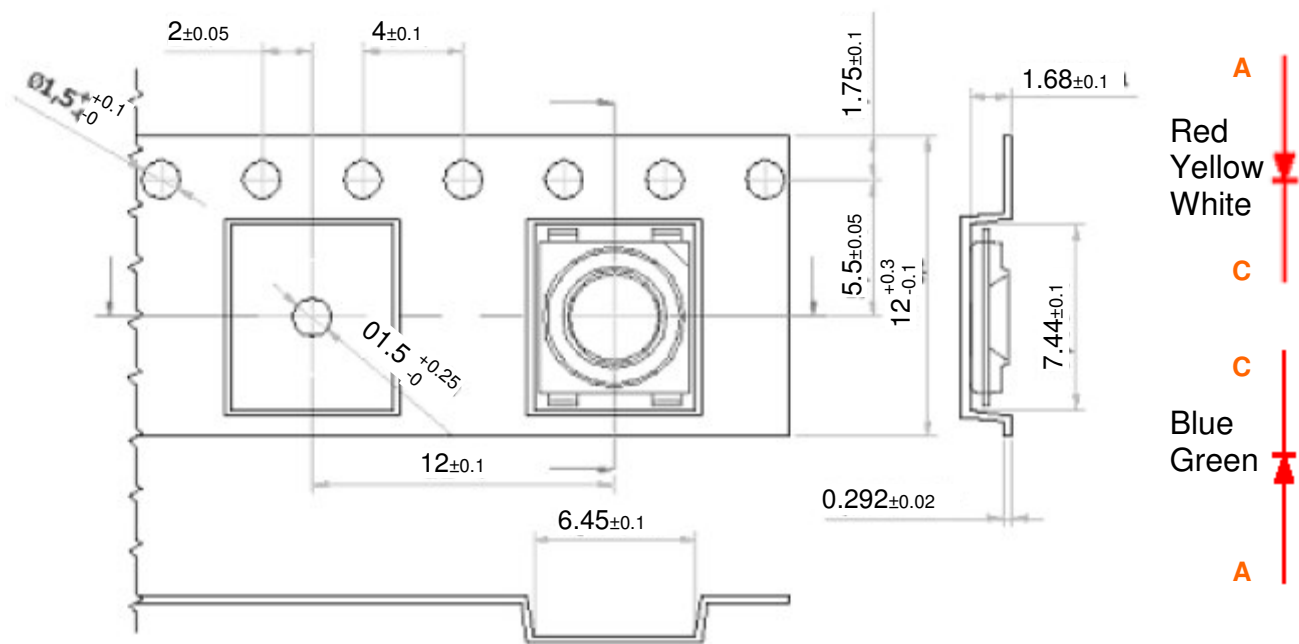

Reel Dimensions (13 inch)

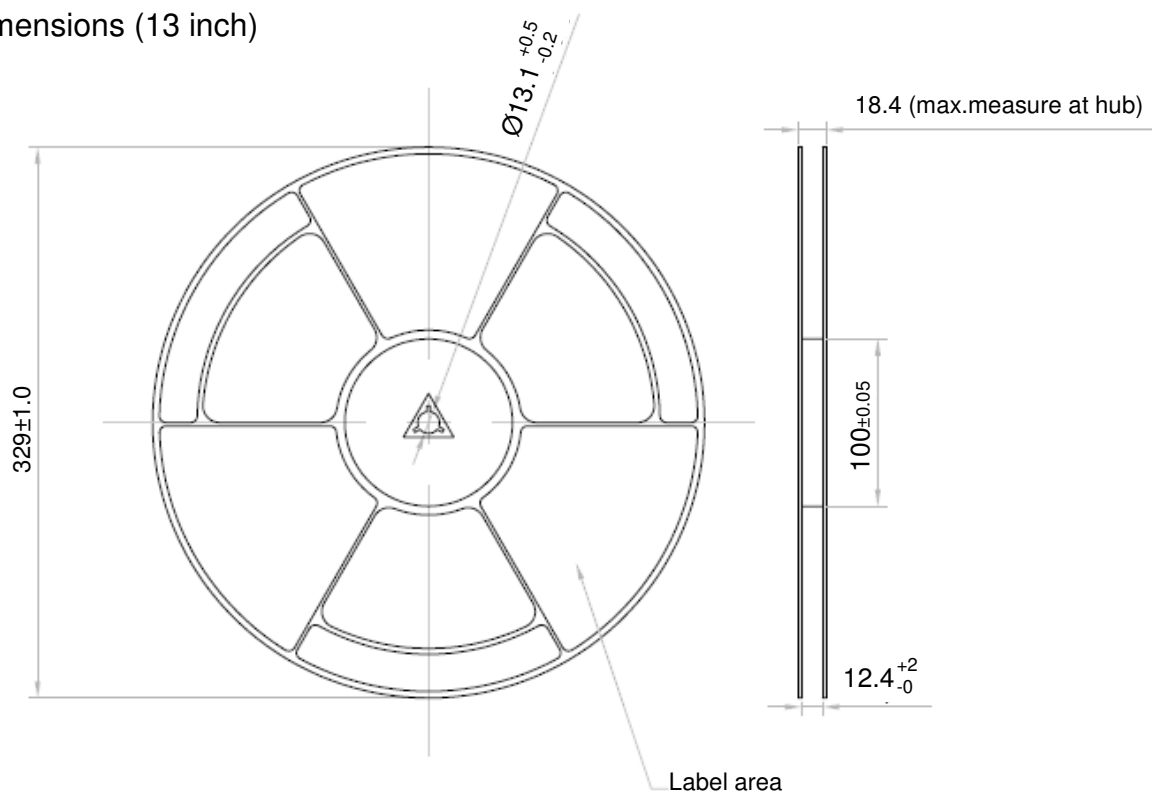

OPTEK reserves the right to make changes at any time in order to improve design and to supply the best product possible.

Moisture Resistant Packaging

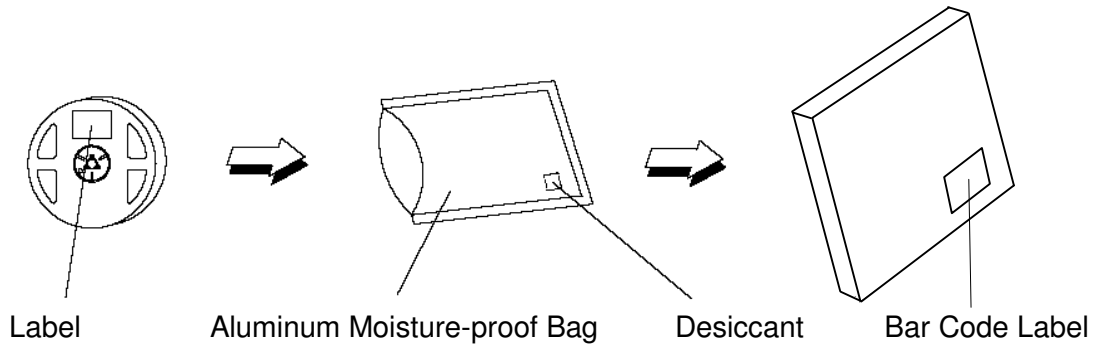

OPTEK reserves the right to make changes at any time in order to improve design and to supply the best product possible.