

power light source

LUXEON® Emitter

Introduction

LUXEON® is a revolutionary, energy efficient and ultra compact new light source, combining the lifetime and reliability advantages of Light Emitting Diodes with the brightness of conventional lighting.

LUXEON Emitters give you total design freedom and unmatched brightness, creating a new world of light.

LUXEON Emitters can be purchased in reels for high volume assembly. For more information, consult your local Lumileds representative.

For high volume applications, custom LUXEON power light source designs are available upon request, to meet your specific needs.



LUXEON Emitter is available in white, green, blue, royal blue, cyan, red, red-orange and amber.



Features

- ◆ Highest flux per LED family in the world
- ◆ Very long operating life (up to 100k hours)
- ◆ Available in White, Green, Blue, Royal Blue, Cyan, Red, Red-Orange, and Amber
- ◆ Lambertian, Batwing or Side Emitting radiation pattern
- ◆ More energy efficient than incandescent and most halogen lamps
- ◆ Low voltage DC operated
- ◆ Cool beam, safe to the touch
- ◆ Instant light (less than 100 ns)
- ◆ Fully dimmable
- ◆ No UV
- ◆ Superior ESD protection

Typical Applications

- ◆ Reading lights (car, bus, aircraft)
- ◆ Portable (flashlight, bicycle)
- ◆ Mini-accent/Uplighters/Downlighters/Orientation
- ◆ Fiber optic alternative/Decorative/Entertainment
- ◆ Bollards/Security/Garden
- ◆ Cove/Undershelf/Task
- ◆ Traffic signaling/Beacons/ Rail crossing and Wayside
- ◆ Indoor/Outdoor Commercial and Residential Architectural
- ◆ Automotive Ext (Stop-Tail-Turn, CHMSL, Mirror Side Repeat)
- ◆ Edge-lit signs (Exit, point of sale)
- ◆ LCD Backlights/Light Guides

PHILIPS

LUMILEDS
LIGHT FROM SILICON VALLEY

Mechanical Dimensions

Batwing

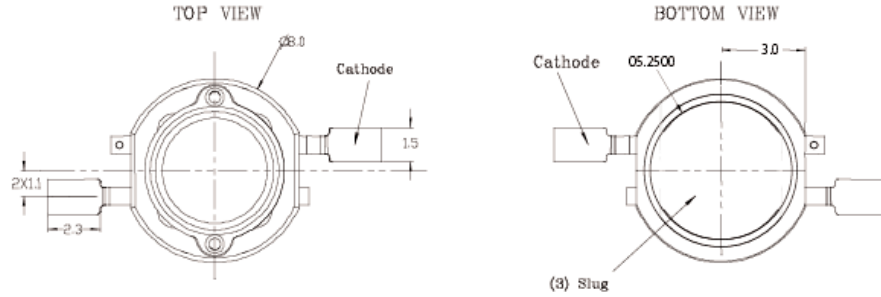

Drawings not to scale

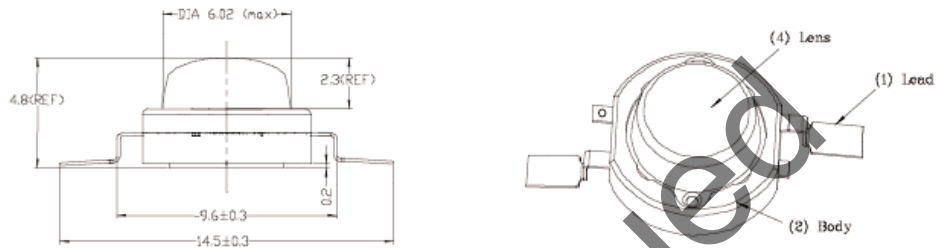

Notes:

1. The anode side of the device is denoted by a hole in the lead frame. Electrical insulation between the case and the board is required—slug of device is not electrically neutral. Do not electrically connect either the anode or cathode to the slug.
2. All dimensions are in millimeters.
3. All dimensions without tolerances are for reference only.

Lambertian

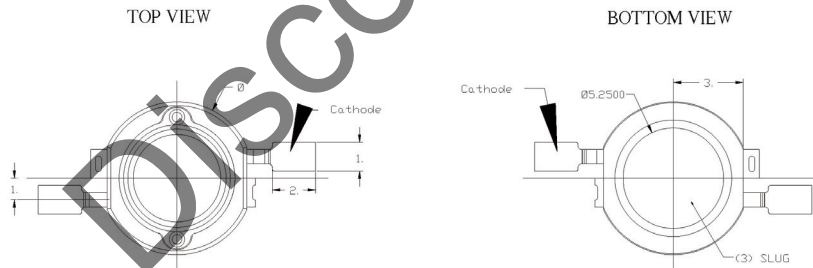

Drawings not to scale

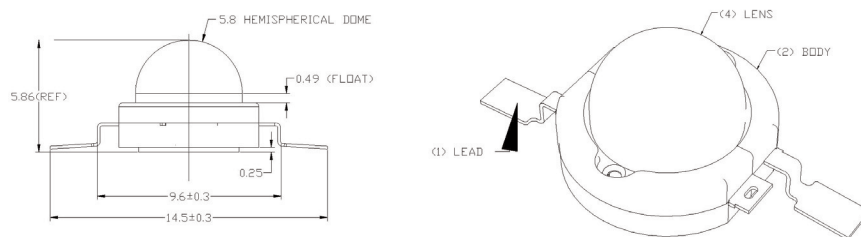

Notes:

1. The anode side of the device is denoted by a hole in the lead frame. Electrical insulation between the case and the board is required—slug of device is not electrically neutral. Do not electrically connect either the anode or cathode to the slug.
2. All dimensions are in millimeters.
3. All dimensions without tolerances are for reference only.

Mechanical Dimensions, Continued

Side Emitting

TOP VIEW

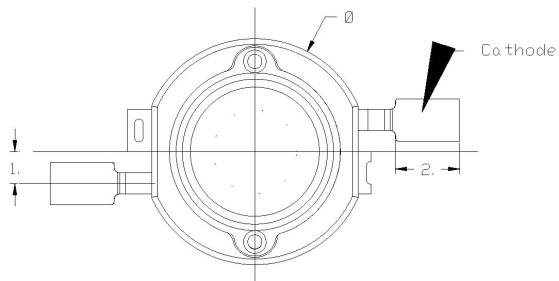

BOTTOM VIEW

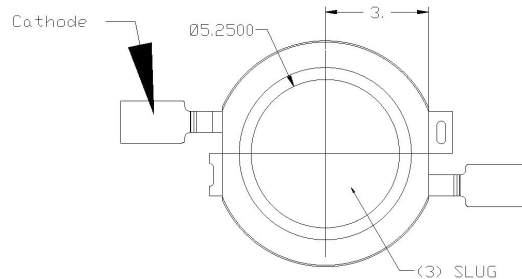

Drawings not to scale

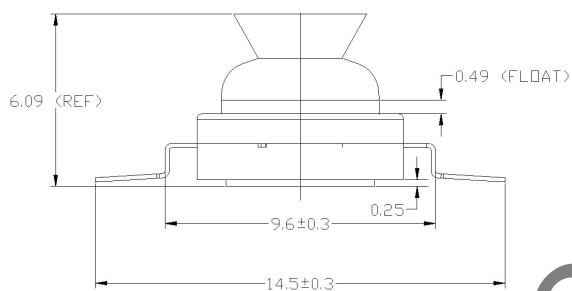

SIDE VIEW

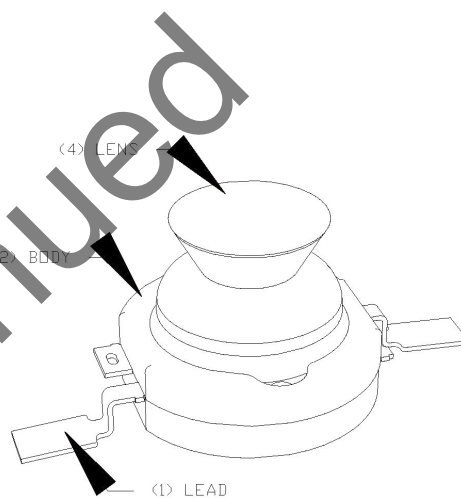

Notes:

1. The anode side of the device is denoted by a hole in the lead frame. Electrical insulation between the case and the board is required—slug of device is not electrically neutral. Do not electrically connect either the anode or cathode to the slug.
2. Caution must be used in handling this device to avoid damage to the lens surfaces that will reduce optical efficiency.
3. All dimensions are in millimeters.
4. All dimensions without tolerances are for reference only.

Flux Characteristics at 350mA, Junction Temperature, $T_J = 25^\circ\text{C}$

Table 1.

Color	LUXEON Emitter	Minimum Luminous Flux (lm) or Radiometric Power (mW) $\Phi_V^{(1,2)}$	Typical Luminous Flux (lm) or Radiometric Power (mW) $\Phi_V^{(2)}$	Radiation Pattern
White ⁽⁵⁾	LXHL-BW02	30.6	45	Batwing
Warm White	LXHL-BW03	13.9	30	
Green	LXHL-BM01	30.6	53	
Cyan	LXHL-BE01	30.6	45	
Blue ⁽³⁾	LXHL-BB01	8.2	16	
Royal blue ⁽⁴⁾	LXHL-BR02	145 mW	220 mW	
Red	LXHL-BD01	13.9	27	
Red	LXHL-BD03	30.6	42	
Red-Orange	LXHL-BH03	39.8	55	
Amber	LXHL-BL01	10.7	25	
Amber	LXHL-BL03	23.5	42	
White	LXHL-PW01	30.6	45	
Green	LXHL-PM01	30.6	53	
Cyan	LXHL-PE01	30.6	45	
Blue ⁽³⁾	LXHL-PB01	8.2	16	
Royal Blue ⁽⁴⁾	LXHL-PR03	145 mW	220 mW	
Red	LXHL-PD01	30.6	44	
Red-Orange	LXHL-PH01	39.8	55	
Amber	LXHL-PL01	23.5	42	
White	LXHL-DW01	23.5	40.5	Side Emitting
Green	LXHL-DM01	23.5	48	
Cyan	LXHL-DE01	23.5	40.5	
Blue ⁽³⁾	LXHL-DB01	8.2	14.5	
Royal blue ⁽⁴⁾	LXHL-DR01	115 mW	198 mW	
Red	LXHL-DD01	30.6	40	
Red-Orange	LXHL-DH01	39.8	50	
Amber	LXHL-DL01	23.5	38	

Notes for Table 1:

1. Minimum luminous flux or radiometric power performance guaranteed within published operating conditions. Philips Lumileds maintains a tolerance of $\pm 10\%$ on flux and power measurements.
2. LUXEON types with even higher luminous flux levels will become available in the future. Please consult your Philips Lumileds Authorized Distributor or Philips Lumileds sales representative for more information.
3. Minimum flux value for 470 nm devices. Due to the CIE eye response curve in the short blue wavelength range, the minimum luminous flux will vary over the Philips Lumileds' blue color range. Luminous flux will vary from a minimum of 6.3 lm at 460 nm to a typical of 20 lm at 480 nm due to this effect. Although the luminous power efficiency is lower in the short blue wavelength range, radiometric power efficiency increases as wavelength decreases. For more information, consult the LUXEON Design Guide, available upon request.
4. Royal Blue product is binned by radiometric power and peak wavelength rather than photometric lumens and dominant wavelength.
5. In July 2003 Philips Lumileds announced a second-generation white batwing product using a new phosphor deposition process resulting in improved color uniformity, LXHL-BW02.

Optical Characteristics at 350mA, Junction Temperature, $T_J = 25^\circ\text{C}$

Table 2.

Radiation Pattern	Color	Dominant Wavelength ⁽¹⁾ λ_D , Peak Wavelength ⁽²⁾ λ_P , or Color Temperature ⁽³⁾			Spectral Half-width ⁽⁴⁾ (nm) $\Delta\lambda_{1/2}$	Temperature Coefficient of Dominant Wavelength (nm/°C) $\Delta\lambda_D / \Delta T_J$	Total Included Angle ⁽⁵⁾ (degrees) $\theta_{0.90V}$	Viewing Angle ⁽⁶⁾ (degrees) $2\theta_{1/2}$
		Min.	CCT Typ.	Max.				
Batwing	White	4500K	5500 K	10000 K	---	---	110	110
	Warm White	2850K	3300K	3800K	---	---	110	110
	Green	520 nm	530 nm	550 nm	35	0.04	110	110
	Cyan	490 nm	505 nm	520 nm	30	0.04	110	110
	Blue	460 nm	470 nm	490 nm	25	0.04	110	110
	Royal Blue ⁽²⁾	440 nm	455 nm	460 nm	20	0.04	110	110
	Red	620.5 nm	625 nm	645 nm	20	0.05	110	110
	Red-Orange	613.5 nm	617 nm	620.5nm	20	0.06	110	110
	Amber	584.5 nm	590 nm	597 nm	14	0.09	110	110
Lambertian	White	4500 K	5500 K	10000 K	---	---	160	140
	Green	520 nm	530 nm	550 nm	35	0.04	160	140
	Cyan	490 nm	505 nm	520 nm	30	0.04	160	140
	Blue	460 nm	470 nm	490 nm	25	0.04	160	140
	Royal Blue ⁽²⁾	440 nm	455 nm	460 nm	20	0.04	160	140
	Red	620.5 nm	627 nm	645 nm	20	0.05	160	140
	Red-Orange	613.5 nm	617 nm	620.5 nm	20	0.06	160	140
	Amber	584.5 nm	590 nm	597 nm	14	0.09	160	140

Optical Characteristics at 350mA, Junction Temperature, $T_J = 25^\circ\text{C}$, Cont.

Table 3.

Radiation Pattern	Color	Dominant Wavelength ⁽¹⁾ λ_D , Peak Wavelength ⁽²⁾ λ_P , or Color Temperature ⁽³⁾			Spectral Half-width ⁽⁴⁾ (nm) $\Delta\lambda_{1/2}$	Temperature Coefficient of Dominant Wavelength (nm/°C) $\Delta\lambda_D / \Delta T_J$	Typical Total Flux Percent within first 45° ⁽⁷⁾ Cum Φ_{45°	Typical Angle of Peak Intensity ⁽⁸⁾ θ_{Peak}
		Min.	CCT Typ.	Max.				
Side Emitting	White	4500 K	5500 K	10000 K	---	---	<15%	75° - 85°
	Green	520 nm	530 nm	550 nm	35	0.04	<15%	75° - 85°
	Cyan	490 nm	505 nm	520 nm	30	0.04	<15%	75° - 85°
	Blue	460 nm	470 nm	490 nm	25	0.04	<15%	75° - 85°
	Royal Blue ⁽²⁾	440 nm	455 nm	460 nm	20	0.04	<15%	75° - 85°
	Red	620.5 nm	627 nm	645 nm	20	0.05	<15%	75° - 85°
	Red-Orange	613.5 nm	617 nm	620.5 nm	20	0.06	<15%	75° - 85°
	Amber	584.5 nm	590 nm	597 nm	14	0.09	<15%	75° - 85°

Notes: (for Tables 2 & 3)

- Dominant wavelength is derived from the CIE 1931 Chromaticity diagram and represents the perceived color. Philips Lumileds maintains a tolerance of $\pm 0.5\text{nm}$ for dominant wavelength measurements.
- Royal Blue product is binned by radiometric power and peak wavelength rather than photometric lumens and dominant wavelength. Philips Lumileds maintains a tolerance of $\pm 2\text{nm}$ for peak wavelength measurements.
- CCT $\pm 5\%$ tester tolerance.
- Spectral width at $1/2$ of the peak intensity.
- Total angle at which 90% of total luminous flux is captured.
- $\theta_{1/2}$ is the off axis angle from lamp centerline where the luminous intensity is $1/2$ of the peak value.
- Cumulative flux percent within $\pm 45^\circ$ from optical axis.
- Off axis angle from lamp centerline where the luminous intensity reaches the peak value.

Notes: (for Tables 2 & 3) Continued

9. CRI (Color Rendering Index) for White product types is 70. CRI for Warm White product type is 90 with typical R_9 value of 70.
10. All red, red-orange and amber products built with Aluminum Indium Gallium Phosphide (AlInGaP).
11. All white, warm white, green, cyan, blue and royal blue products built with Indium Gallium Nitride (InGaN).
12. Blue and Royal Blue power light sources represented here are IEC825 Class 2 for eye safety.

Electrical Characteristics at 350mA, Junction Temperature, $T_J = 25^\circ\text{C}$

Table 4.

Radiation Pattern	Color	Forward Voltage V_F ^[1]			Dynamic Resistance ^[2] (Ω) R_D	Temperature Coefficient of Forward Voltage ^[3] (mV/ $^\circ\text{C}$) $\Delta V_F / \Delta T_J$	Thermal Resistance, Junction to Case ($^\circ\text{C}/\text{W}$) $R_{\theta_{J-C}}$
		Min.	Typ.	Max.			
Batwing	White	2.79	3.42	3.99	1.0	-2.0	15
	Warm White	2.79	3.42	3.99	1.0	-2.0	15
	Green	2.79	3.42	3.99	1.0	-2.0	15
	Cyan	2.79	3.42	3.99	1.0	-2.0	15
	Blue	2.79	3.42	3.99	1.0	-2.0	15
	Royal Blue	2.79	3.42	3.99	1.0	-2.0	15
	Red (BD01)	2.31	2.85	3.27	2.4	-2.0	15
	Red (BD03)	2.31	2.95	3.51	2.4	-2.0	18
	Red-Orange	2.31	2.95	3.51	2.4	-2.0	18
	Amber (BL01)	2.31	2.85	3.27	2.4	-2.0	15
Amber (BL03)	2.31	2.95	3.51	2.4	-2.0	18	
Lambertian	White	2.79	3.42	3.99	1.0	-2.0	15
	Green	2.79	3.42	3.99	1.0	-2.0	15
	Cyan	2.79	3.42	3.99	1.0	-2.0	15
	Blue	2.79	3.42	3.99	1.0	-2.0	15
	Royal Blue	2.79	3.42	3.99	1.0	-2.0	15
	Red	2.31	2.85	3.51	2.4	-2.0	18
	Red-Orange	2.31	2.95	3.51	2.4	-2.0	18
	Amber	2.31	2.95	3.51	2.4	-2.0	18
Side Emitting	White	2.79	3.42	3.99	1.0	-2.0	15
	Green	2.79	3.42	3.99	1.0	-2.0	15
	Cyan	2.79	3.42	3.99	1.0	-2.0	15
	Blue	2.79	3.42	3.99	1.0	-2.0	15
	Royal Blue	2.79	3.42	3.99	1.0	-2.0	15
	Red	2.31	2.95	3.51	2.4	-2.0	18
	Red-Orange	2.31	2.95	3.51	2.4	-2.0	18
	Amber	2.31	2.95	3.51	2.4	-2.0	18

Notes for Table 4:

1. Philips Lumileds maintains a tolerance of $\pm 0.06\text{V}$ on forward voltage measurements.
2. Dynamic resistance is the inverse of the slope in linear forward voltage model for LEDs. See Figures 3a and 3b. Measured between $25^\circ\text{C} \leq T_J \leq 110^\circ\text{C}$ at $I_F = 350\text{mA}$.

Absolute Maximum Ratings

Table 5.

Parameter	White/Green/ Cyan/Blue/ Royal Blue	Warm White	Red/ Red-Orange/ Amber
DC Forward Current (mA) ^[1]	350	350	385
Peak Pulsed Forward Current (mA)	500	500	550
Average Forward Current (mA)	350	350	350
ESD Sensitivity ^[2]	± 16,000V HBM		
LED Junction Temperature (°C)	135	120	120
Storage Temperature (°C)	-40 to +120	-40 to +120	-40 to +120
Soldering Temperature (°C) ^[3]	260 for 5 seconds max	260 for 5 seconds max	260 for 5 seconds max

Notes for Table 5:

1. Proper current derating must be observed to maintain junction temperature below the maximum. For more information, consult the LUXEON Design Guide, available upon request.
2. LEDs are not designed to be driven in reverse bias. Please consult Philips Lumileds' Application Brief AB11 for further information.
3. Measured at leads, during lead soldering and slug attach, body temperature must not exceed 120°C. LUXEON emitters cannot be soldered by general IR or Vapor-phase reflow, nor by wave soldering. Lead soldering is limited to selective heating of the leads, such as by hot-bar reflow, fiber focussed IR, or hand soldering. The package back plane (slug) may not be attached by soldering, but rather with a thermally conductive adhesive. Electrical insulation between the slug and the board is required. Please consult Philips Lumileds' Application Brief AB10 on *LUXEON Emitter Assembly Information* for further details on assembly methods.

Discontinued

Wavelength Characteristics, $T_J = 25^\circ\text{C}$

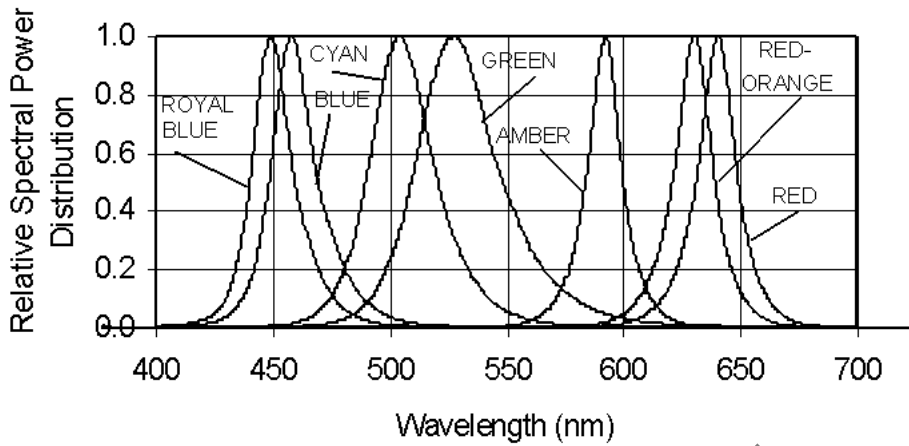

Figure 1a. Relative Intensity vs. Wavelength

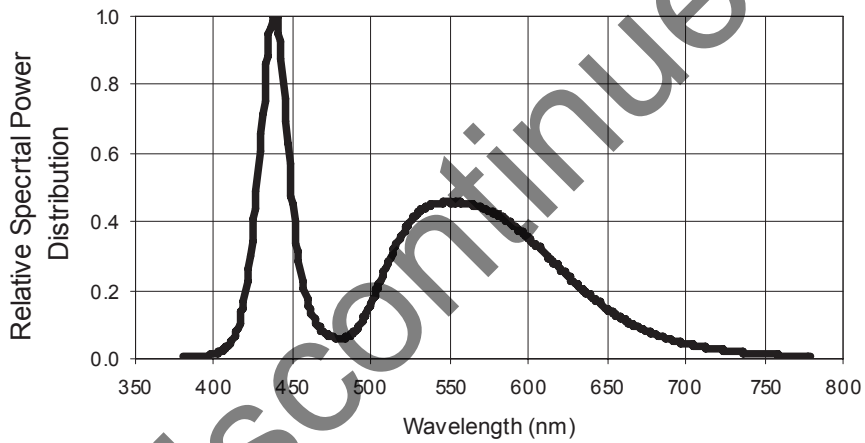

Figure 1b. White Color Spectrum of Typical CCT Part, Integrated Measurement. Applicable for LXHL-BW02.

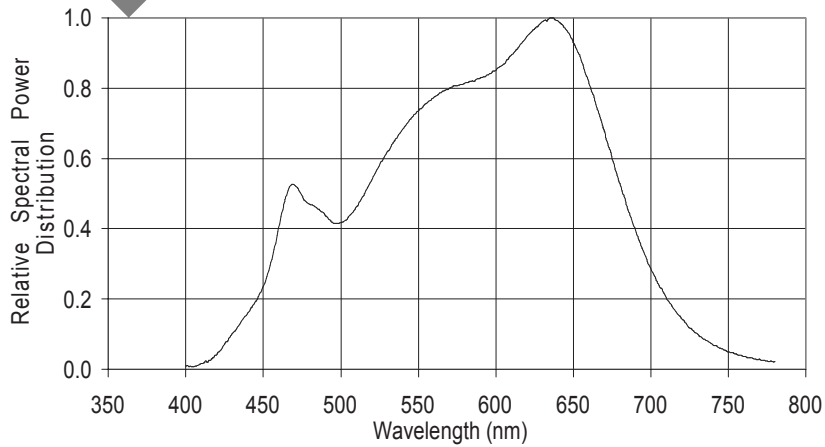

Figure 1c. White Color Spectrum of Typical Warm White Part, Integrated Measurement. Applicable for LXHL-BW03.

Light Output Characteristics

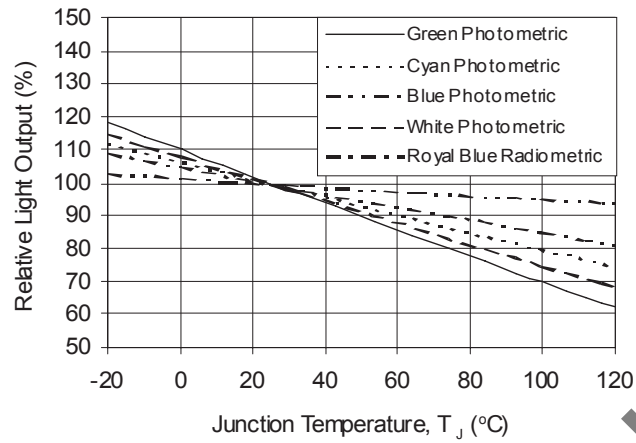

Figure 2a. Relative Light Output vs. Junction Temperature for White, Warm White, Green, Cyan, Blue and Royal Blue.

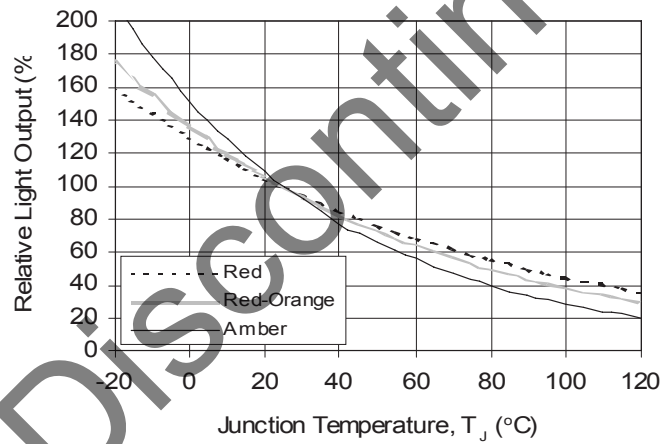

Figure 2b. Relative Light Output vs. Junction Temperature for Red, Red-Orange and Amber.

Forward Current Characteristics, $T_J = 25^\circ\text{C}$

Note:

Driving these high power devices at currents less than the test conditions may produce unpredictable results and may be subject to variation in performance. Pulse width modulation (PWM) is recommended for dimming effects.

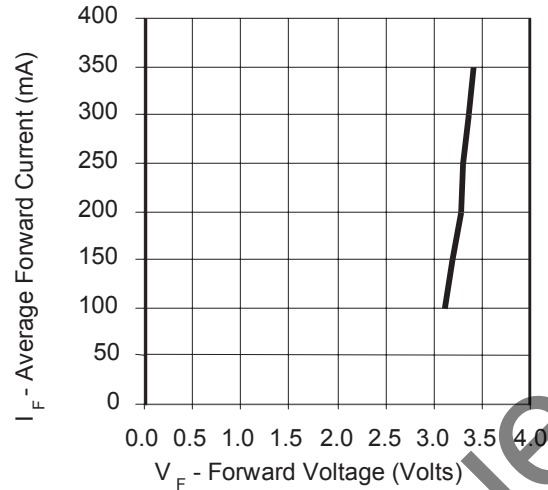

Figure 3a. Forward Current vs. Forward Voltage for White, Warm White, Green, Cyan, Blue, and Royal Blue.

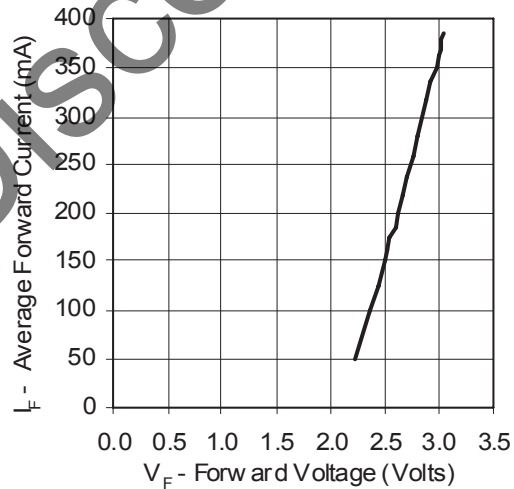

Figure 3b. Forward Current vs. Forward Voltage for Red, Red-Orange and Amber.

Forward Current Characteristics, $T_J = 25^\circ\text{C}$, Continued

Note:

Driving these high power devices at currents less than the test conditions may produce unpredictable results and may be subject to variation in performance. Pulse width modulation (PWM) is recommended for dimming effects.

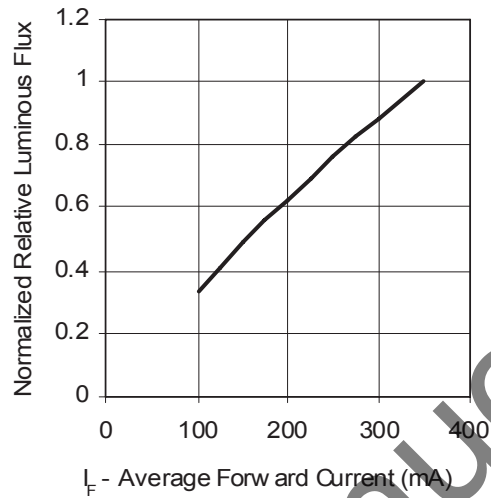

Figure 4a. Relative Luminous Flux vs. Forward Current for White, Warm White, Green, Cyan, Blue, and Royal Blue at $T_J = 25^\circ\text{C}$ maintained.

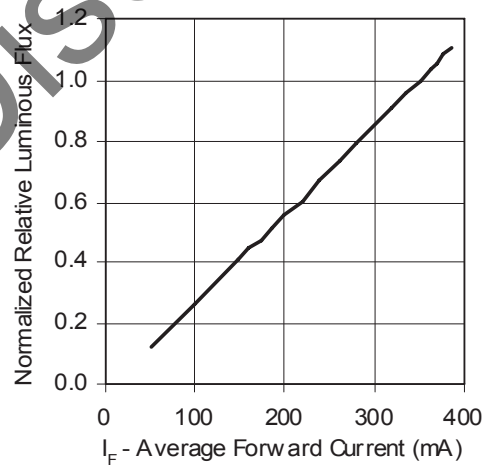

Figure 4b. Relative Luminous Flux vs. Forward Current for Red, Red-Orange and Amber at $T_J = 25^\circ\text{C}$ maintained.

Current Derating Curves

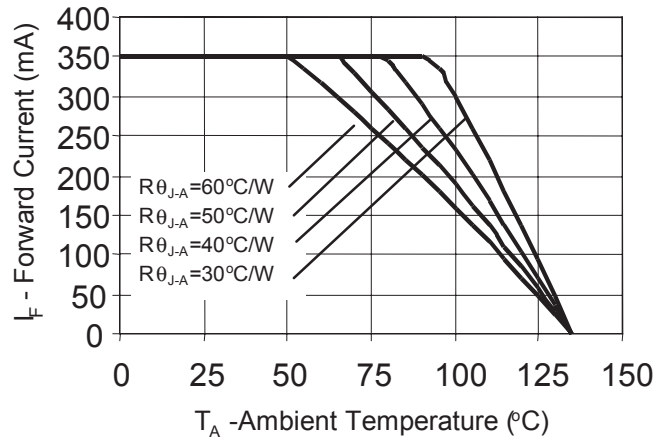

Figure 5a. Maximum Forward Current vs. Ambient Temperature.
Derating based on $T_{JMAX} = 135^{\circ}\text{C}$ for White, Green, Cyan, Blue, and Royal Blue.

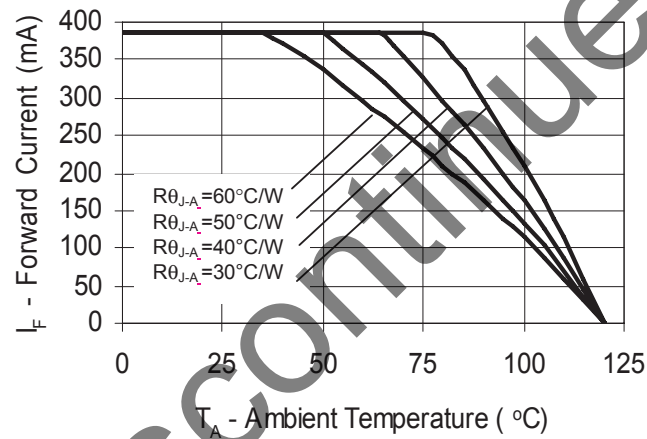

Figure 5b. Maximum Forward Current vs. Ambient Temperature.
Derating based on $T_{JMAX} = 120^{\circ}\text{C}$ for Red, Red-Orange and Amber.

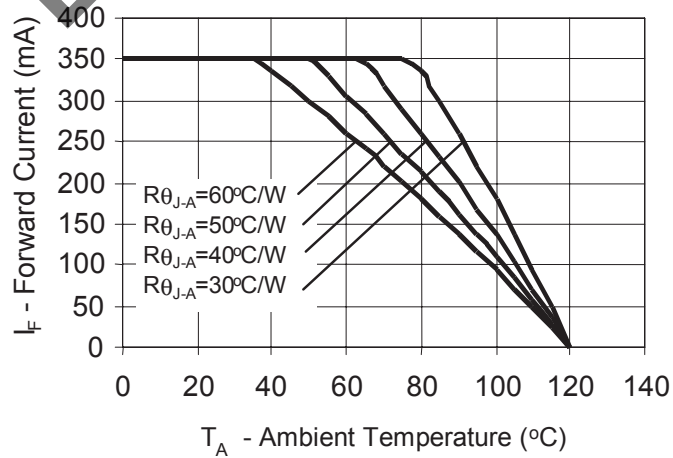

Figure 5c. Maximum Forward Current vs. Ambient Temperature.
Derating based on $T_{JMAX} = 120^{\circ}\text{C}$ for Warm White.

Typical Batwing Representative Spatial Radiation Pattern

Note:

For more detailed technical information regarding LUXEON radiation patterns, please consult your Philips Lumileds Authorized Distributor or Philips Lumileds sales representative.

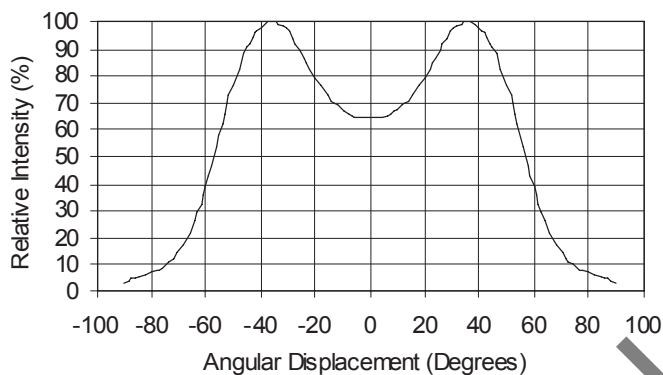

Figure 6a. Typical Representative Spatial Radiation Pattern for LUXEON Emitter Warm White (LXHL-BW03).

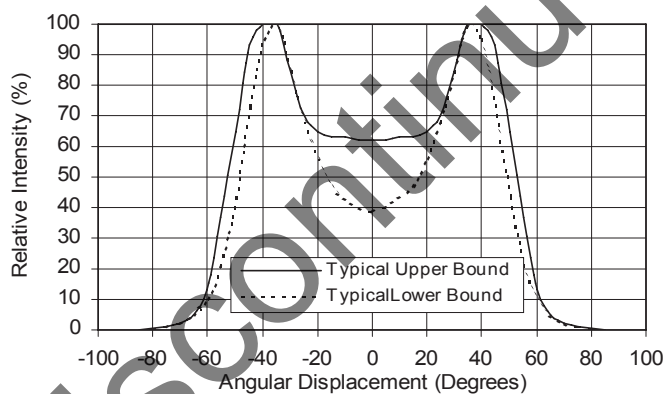

Figure 6b. Typical Representative Spatial Radiation Pattern for LUXEON Emitter Green, Cyan, Blue and Royal Blue.

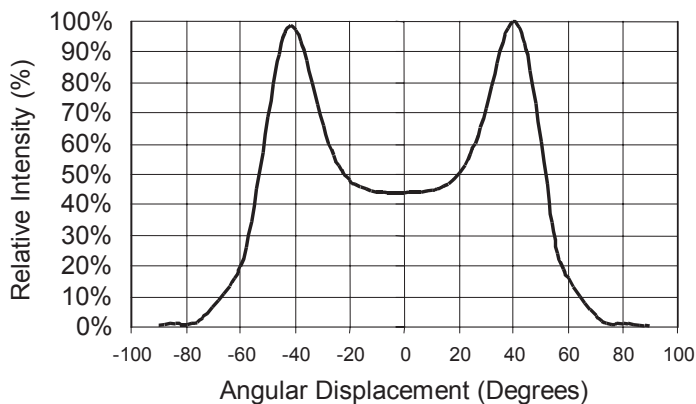

Figure 6c. Typical Representative Spatial Radiation Pattern for LUXEON Emitter White (LXHL-BW02).

Typical Batwing Representative Spatial Radiation Pattern, Continued

Note:

For more detailed technical information regarding LUXEON radiation patterns, please consult your Philips Lumileds Authorized Distributor or Philips Lumileds sales representative.

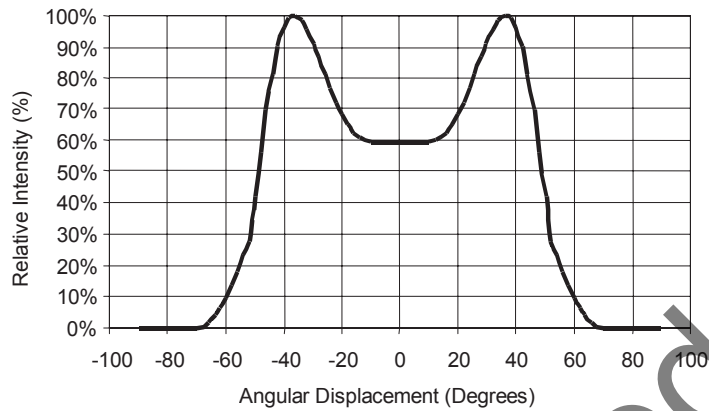

Figure 6d. Typical Representative Spatial Radiation Pattern for LUXEON Emitter Red (LXHL-BD01) and Amber (LXHL-BL01).

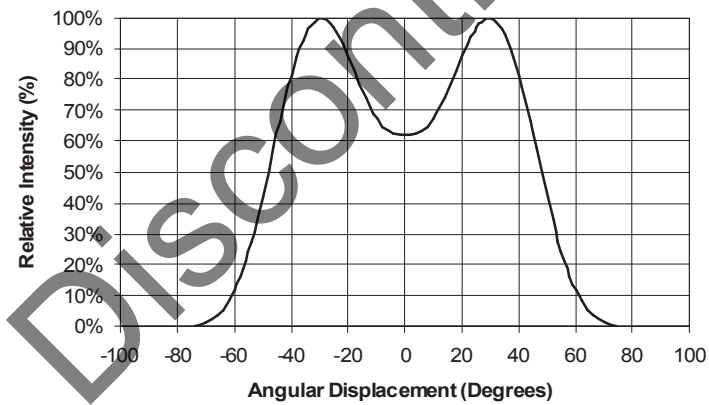

Figure 6e. Typical Representative Spatial Radiation Pattern for LUXEON Emitter Red (LXHL-BD03), Red-Orange (LXHL-BH03) and Amber (LXHL-BL03).

Typical Lambertian Representative Spatial Radiation Pattern

Note:

For more detailed technical information regarding LUXEON radiation patterns, please consult your Philips Lumileds Authorized Distributor or Philips Lumileds sales representative.

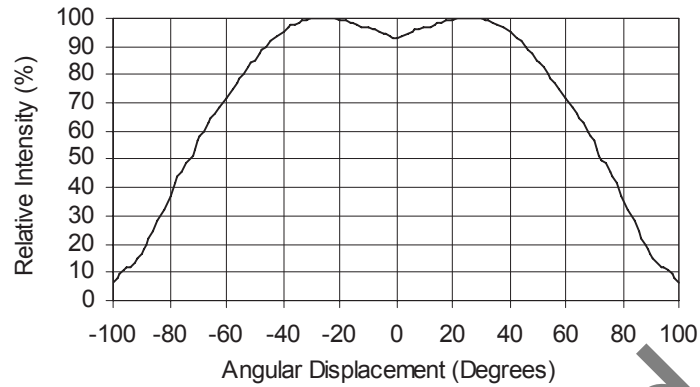

Figure 7a. Typical Representative Spatial Radiation Pattern for LUXEON Emitter Red, Red-Orange and Amber.

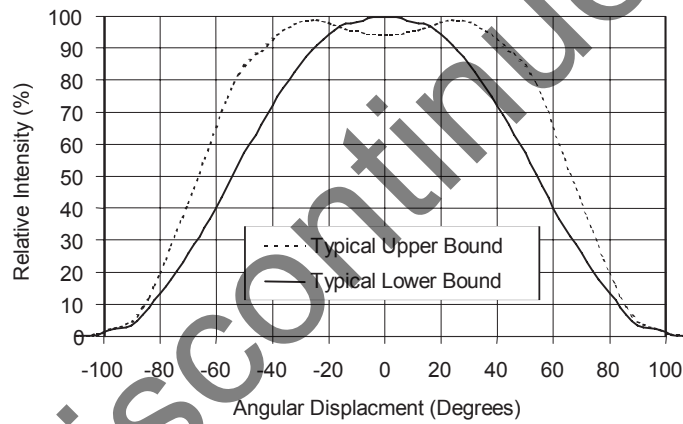

Figure 7b. Typical Representative Spatial Radiation Pattern for LUXEON Emitter White, Green, Cyan, Blue and Royal Blue.

Typical Side Emitting Representative Spatial Radiation Pattern

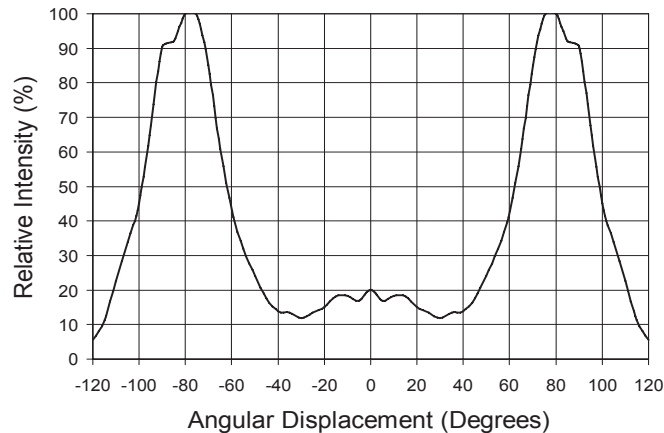

Figure 8a. Typical Representative Spatial Radiation Pattern for LUXEON Emitter Red, Red-Orange and Amber.

Typical Side Emitting Representative Spatial Radiation Pattern, Continued

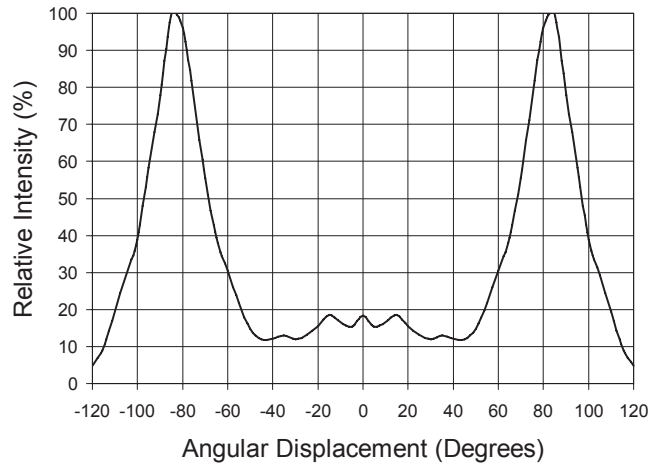

Figure 8b. Typical Representative Spatial Radiation Pattern for LUXEON Emitter White, Green, Cyan, Blue and Royal Blue.

Average Lumen Maintenance Characteristics

Lifetime for solid-state lighting devices (LEDs) is typically defined in terms of lumen maintenance—the percentage of initial light output remaining after a specified period of time. Philips Lumileds projects that LUXEON products will deliver on average 70% lumen maintenance at 50,000 hours of operation. This performance is based on independent test data, Philips Lumileds historical data from tests run on similar material systems, and internal LUXEON reliability testing. This projection is based on constant current 350 mA operation with junction temperature maintained at or below 90°C. Observation of design limits included in this data sheet is required in order to achieve this projected lumen maintenance.

Discontinued

Emitter Reel Packaging

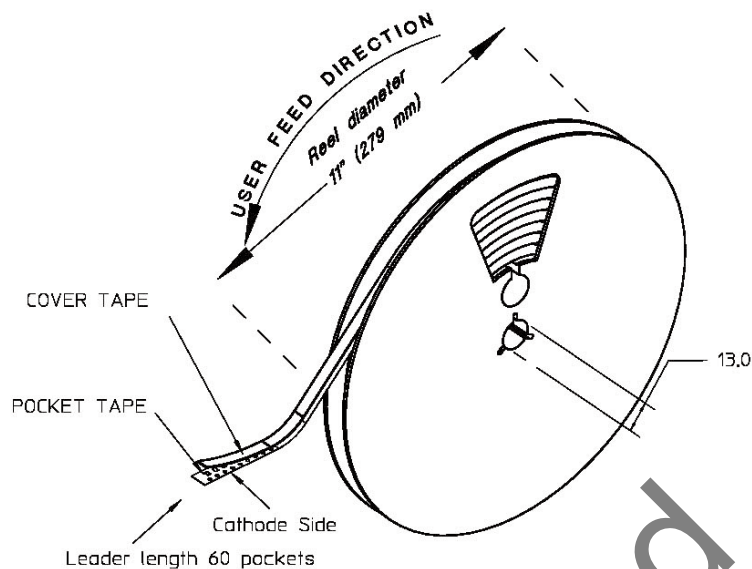

Figure 9. Reel dimensions and orientation.

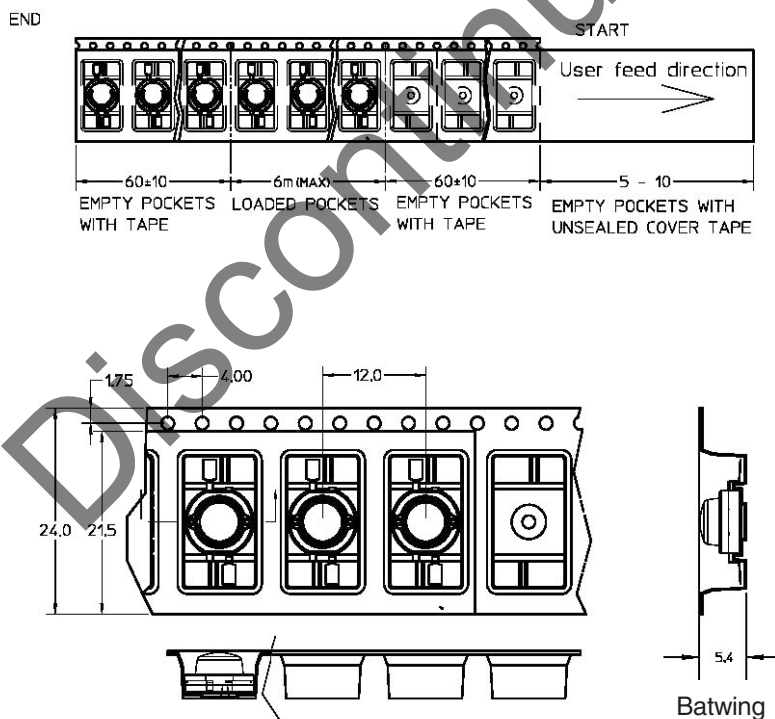

Figure 10. Tape dimensions for Batwing radiation pattern.

Notes:

1. LUXEON emitters should be picked up by the body (not the lens) during placement. The inner diameter of the pick-up collet should be greater than or equal to 6.5 mm. Please consult Philips Lumileds Application Brief AB10 on LUXEON Emitter assembly information for further details on assembly methods.
2. Drawings not to scale.
3. All dimensions are in millimeters.
4. All dimensions without tolerances are for reference only.

Emitter Reel Packaging

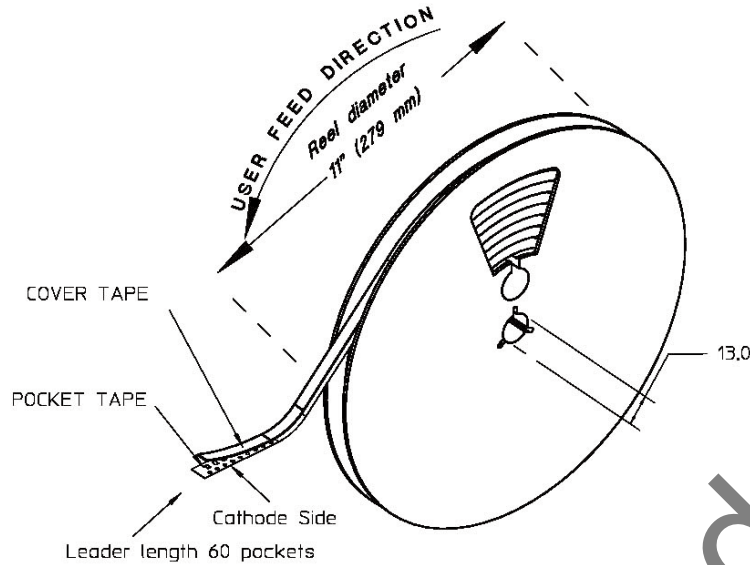

Figure 11. Reel dimensions and orientation.

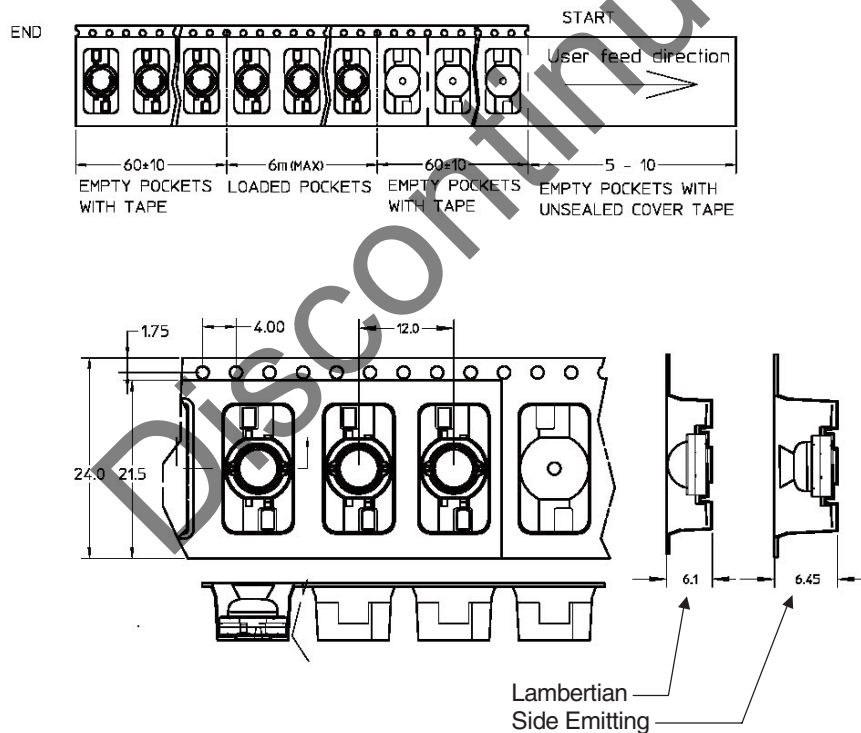

Figure 12. Tape dimensions for Lambertian and Side Emitting radiation patterns.

Notes:

1. LUXEON emitters should be picked up by the body (not the lens) during placement. The inner diameter of the pick-up collet should be greater than or equal to 6.5 mm. Please consult Philips Lumileds Application Brief AB10 on LUXEON Emitter assembly information for further details on assembly methods.
2. Drawings not to scale.
3. All dimensions are in millimeters.
4. All dimensions without tolerances are for reference only.

Company Information

Philips Lumileds Lighting Company is a world class supplier of Light Emitting Diodes (LEDs) and produces billions of LEDs annually. Philips Lumileds is a fully integrated supplier producing core LED material in all three base colors (red, green, blue) and white. Philips Lumileds has R&D centers in San Jose, California and in The Netherlands as well as production capabilities in San Jose, Penang Malaysia and Singapore. Founded in 1999, Philips Lumileds is the high-flux LED technology leader and is dedicated to bridging the gap between solid-state LED technology and the lighting world. Philips Lumileds technologies, LEDs and systems are enabling new applications and markets in the lighting world.

Philips Lumileds may make process or materials changes affecting the performance or other characteristics of our products. These products supplied after such changes will continue to meet published specifications, but may not be identical to products supplied as samples or under prior orders.



WWW.LUXEON.COM

WWW.LUMILEDSFUTURE.COM

FOR TECHNICAL ASSISTANCE OR THE LOCATION OF YOUR NEAREST SALES OFFICE CONTACT ANY OF THE FOLLOWING:

NORTH AMERICA:

1 888 589 3662

AMERICAS@FUTURELIGHTINGSOLUTIONS.COM

EUROPE:

00 800 443 88 873

EUROPE@FUTURELIGHTINGSOLUTIONS.COM

ASIA PACIFIC:

800 5864 5337

ASIA@FUTURELIGHTINGSOLUTIONS.COM

JAPAN:

800 5864 5337

JAPAN@FUTURELIGHTINGSOLUTIONS.COM

©2007 Philips Lumileds Lighting Company. All rights reserved. Product specifications are subject to change without notice. Luxeon is a registered trademark of the Philips Lumileds Lighting Company in the United States and other countries.

Discontinued