

| ELECTRO-OPTICAL CHARACTERISTICS $T_A=25^{\circ}\text{C}$ $I_f=20\text{mA}$ | | | | |
|--|------------------|-----|------|----------------------------|
| PARAMETER | MIN | TYP | MAX | UNITS TEST COND |
| PEAK WAVELENGTH | | | | nm |
| FORWARD VOLTAGE | 2.7 | | 3.5 | V_f |
| REVERSE VOLTAGE | 5.0 | | | V_r $I_f=100\mu\text{A}$ |
| AXIAL INTENSITY | 2250 | | 4500 | mcd $I_f=20\text{mA}$ |
| VIEWING ANGLE | | 120 | | $2x$ theta |
| EMITTED COLOR: | WHITE | | | |
| EPOXY LENS FINISH: | WATER CLEAR LENS | | | |

| LIMITS OF SAFE OPERATION AT 25°C PER CHIP | | |
|---|------------|----------|
| PARAMETER | MAX | UNITS |
| PEAK FORWARD CURRENT* | 100 | mA |
| STEADY CURRENT | 30 | mA |
| POWER DISSIPATION | 110 | mW |
| DERATE FROM 25°C | -1.2 | mW/°C |
| OPERATING TEMP. | -40 TO +85 | °C |
| STORAGE TEMP. | -40 TO +85 | °C |
| SOLDERING TEMP. | +260 | °C |
| 2.0mm FROM BODY | 3 | SEC. MAX |

* $t < 10\mu\text{s}$

NOTES:

1. THE POLARITY MARK IS ORIENTED TOWARDS THE TAPE SPROCKET HOLE.
2. 2,000 PER REEL.

CAUTION: MOISTURE SENSITIVE DEVICE
PER JEDEC LEVEL 2 STANDARDS

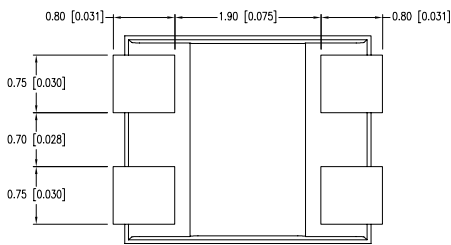
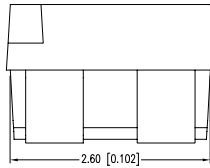
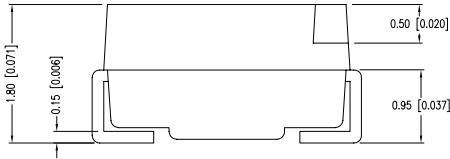

*UNLESS OTHERWISE SPECIFIED TOLERANCES PER DECIMAL PRECISION ARE: X=±1 (±0.039), XX=±0.5 (±0.020), XXX=±0.25 (±0.010), XXXX=±0.127 (±0.005). LEAD SIZE=±0.05 (±0.002), LEAD LENGTH=±0.75 (±0.030). MIN= +DECIMAL PRECISION -0.00, MAX= +0.00 -DECIMAL PRECISION UNCONTROLLED DOCUMENT



290 E. HELEN ROAD
PALATINE, IL 60067-6976
PHONE: +1.847.359.2790
FAX: +1.847.359.6538
WEB: WWW.LUMEX.COM

2.8mm x 3.2mm SML /W REFLECTOR CUP, DUAL CHIP, ULTRA WHITE LED, WATER CLEAR LENS, 2k PER REEL.

THE SPECIFICATIONS MAY CHANGE AT ANY TIME WITHOUT NOTICE DUE TO NEW MATERIALS OR PRODUCT IMPROVEMENT.

CONFIDENTIAL INFORMATION
THE INFORMATION CONTAINED IN THIS DOCUMENT IS THE PROPERTY OF LUMEX INC. EXCEPT AS SPECIFICALLY AUTHORIZED IN WRITING BY LUMEX INC., THE HOLDER OF THIS DOCUMENT SHALL KEEP ALL INFORMATION CONTAINED HEREIN CONFIDENTIAL AND SHALL PROTECT SAME IN WHOLE OR IN PART FROM DISCLOSURE AND DISSEMINATION TO ALL THIRD PARTIES.

| | | | |
|--------|-----------|-----------|----|
| DATE: | 02.3.11 | DRAWN BY: | AB |
| PAGE: | 1 OF 3 | CHKD BY: | KF |
| SCALE: | NTS | APRVD BY: | JD |
| UNIT: | mm [INCH] | | Ⓝ |

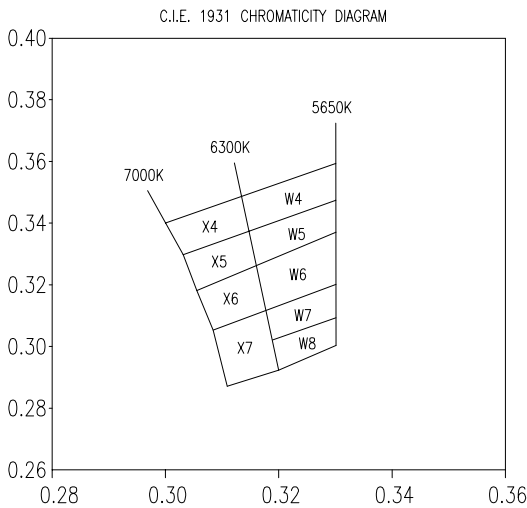

I_f = 20mA

| CCT | BIN CODE | CIE_x | CIE_y |
|-----------------|----------|--------|--------|
| 6300K ~7000K | X4 | 0.3010 | 0.3420 |
| | | 0.3140 | 0.3550 |
| | | 0.3150 | 0.3440 |
| | | 0.3030 | 0.3330 |
| | X5 | 0.3050 | 0.3220 |
| | | 0.3030 | 0.3330 |
| | | 0.3150 | 0.3440 |
| | | 0.3160 | 0.3330 |
| | X6 | 0.3080 | 0.3110 |
| | | 0.3050 | 0.3220 |
| | | 0.3160 | 0.3330 |
| | | 0.3170 | 0.3200 |
| | X7 | 0.3080 | 0.3110 |
| | | 0.3170 | 0.3200 |
| | | 0.3190 | 0.3000 |
| | | 0.3110 | 0.2930 |

I_f = 20mA

| CCT | BIN CODE | CIE_x | CIE_y |
|-----------------|----------|--------|--------|
| 5650K ~6300K | W4 | 0.3290 | 0.3690 |
| | | 0.3290 | 0.3570 |
| | | 0.3150 | 0.3440 |
| | | 0.3140 | 0.3550 |
| | W5 | 0.3290 | 0.3450 |
| | | 0.3160 | 0.3330 |
| | | 0.3150 | 0.3440 |
| | | 0.3290 | 0.3570 |
| | W6 | 0.3290 | 0.3450 |
| | | 0.3290 | 0.3310 |
| | | 0.3170 | 0.3200 |
| | | 0.3160 | 0.3330 |
| | W7 | 0.3290 | 0.3310 |
| | | 0.3290 | 0.3200 |
| | | 0.3180 | 0.3100 |
| | | 0.3170 | 0.3200 |
| | W8 | 0.3290 | 0.3200 |
| | | 0.3290 | 0.3100 |
| | | 0.3190 | 0.3000 |
| | | 0.3180 | 0.3100 |

*UNLESS OTHERWISE SPECIFIED TOLERANCES PER DECIMAL PRECISION ARE: X=±1 (±0.039), XX=±0.5 (±0.020), XXX=±0.25 (±0.010), XXXX=±0.127 (±0.005). LEAD SIZE=±0.05 (±0.002), LEAD LENGTH=±0.75 (±0.030). MIN.=^{+DECIMAL PRECISION}_{-0.00} MAX.=^{+0.00}_{-DECIMAL PRECISION} UNCONTROLLED DOCUMENT



290 E. HELEN ROAD
PALATINE, IL 60067-6976
PHONE: +1.847.359.2790
FAX: +1.847.359.6538
WEB: WWW.LUMEX.COM

2.8mm x 3.2mm SML /W REFLECTOR CUP, DUAL CHIP, ULTRA WHITE LED, WATER CLEAR LENS, 2k PER REEL.

THE SPECIFICATIONS MAY CHANGE AT ANY TIME WITHOUT NOTICE DUE TO NEW MATERIALS OR PRODUCT IMPROVEMENT.
CONFIDENTIAL INFORMATION
THE INFORMATION CONTAINED IN THIS DOCUMENT IS THE PROPERTY OF LUMEX INC. EXCEPT AS SPECIFICALLY AUTHORIZED IN WRITING BY LUMEX INC., THE HOLDER OF THIS DOCUMENT SHALL KEEP ALL INFORMATION CONTAINED HEREIN CONFIDENTIAL AND SHALL PROTECT SAME IN WHOLE OR IN PART FROM DISCLOSURE AND DISSEMINATION TO ALL THIRD PARTIES.

| | | | |
|--------|-----------|-----------|----|
| DATE: | 02.3.11 | DRAWN BY: | AB |
| PAGE: | 2 OF 3 | CHKD BY: | KF |
| SCALE: | NTS | APRVD BY: | JD |
| UNIT: | mm [INCH] | | Ⓢ |

LEAD FREE REFLOW PROFILE

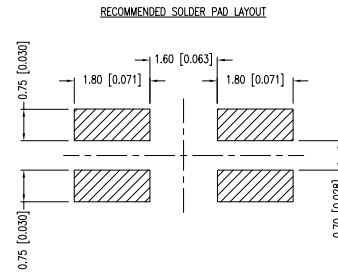
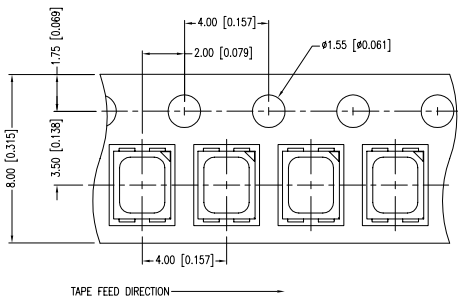
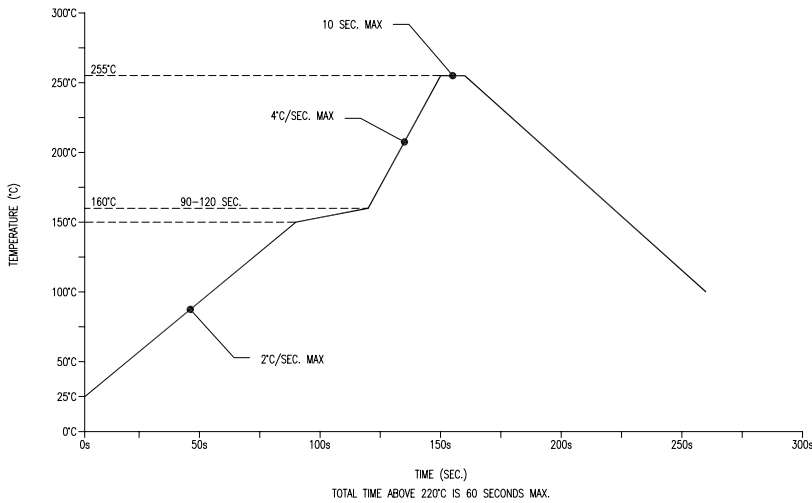

*UNLESS OTHERWISE SPECIFIED TOLERANCES PER DECIMAL PRECISION ARE: X=±1 (±0.039), XX=±0.5 (±0.020), XXX=±0.25 (±0.010), XXXX=±0.127 (±0.005). LEAD SIZE=±0.05 (±0.002), LEAD LENGTH=±0.75 (±0.030), MIN.= +DECIMAL PRECISION -0.00, MAX.= +0.00 -DECIMAL PRECISION



290 E. HELEN ROAD
PALATINE, IL 60067-6976
PHONE: +1.847.359.2790
FAX: +1.847.359.6538
WEB: WWW.LUMEX.COM

2.8mm x 3.2mm SML /W REFLECTOR CUP, DUAL CHIP, ULTRA WHITE LED, WATER CLEAR LENS, 2k PER REEL.

THE SPECIFICATIONS MAY CHANGE AT ANY TIME WITHOUT NOTICE DUE TO NEW MATERIALS OR PRODUCT IMPROVEMENT.

CONFIDENTIAL INFORMATION

THE INFORMATION CONTAINED IN THIS DOCUMENT IS THE PROPERTY OF LUMEX INC. EXCEPT AS SPECIFICALLY AUTHORIZED IN WRITING BY LUMEX INC., THE HOLDER OF THIS DOCUMENT SHALL KEEP ALL INFORMATION CONTAINED HEREIN CONFIDENTIAL AND SHALL PROTECT SAME IN WHOLE OR IN PART FROM DISCLOSURE AND DISSEMINATION TO ALL THIRD PARTIES.

| | | | |
|--------|-----------|-----------|----|
| DATE: | 02.3.11 | DRAWN BY: | AB |
| PAGE: | 3 OF 3 | CHKD BY: | KF |
| SCALE: | NTS | APRVD BY: | JD |
| UNIT: | mm [INCH] | | Ⓝ |