

LED55BF LED55CF LED56F

PACKAGE DIMENSIONS

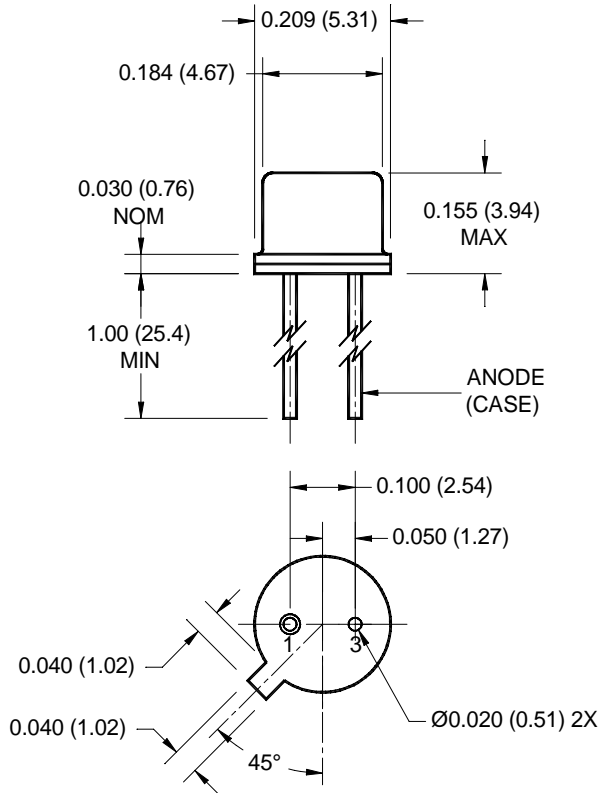

NOTES:

1. Dimensions for all drawings are in inches (mm).
2. Tolerance of $\pm .010$ (.25) on all non-nominal dimensions unless otherwise specified.

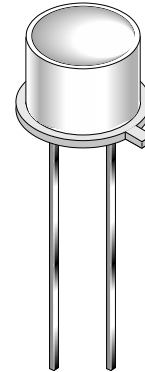

SCHEMATIC

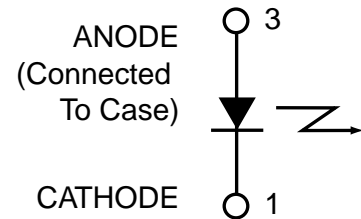

DESCRIPTION

The LED55BF/LED55CF/LED56F series are 940nm LEDs in a wide angle, TO-46 package.

FEATURES

- Good optical to mechanical alignment
- Mechanically and wavelength matched to the TO-18 series phototransistor
- Hermetically sealed package
- High irradiance level

LED55BF LED55CF LED56F

ABSOLUTE MAXIMUM RATINGS ($T_A = 25^\circ\text{C}$ unless otherwise specified)			
Parameter	Symbol	Rating	Unit
Operating Temperature	T_{OPR}	-65 to +125	$^\circ\text{C}$
Storage Temperature	T_{STG}	-65 to +150	$^\circ\text{C}$
Soldering Temperature (Iron) ^(3,4,5 and 6)	T_{SOL-I}	240 for 5 sec	$^\circ\text{C}$
Soldering Temperature (Flow) ^(3,4 and 6)	T_{SOL-F}	260 for 10 sec	$^\circ\text{C}$
Continuous Forward Current	I_F	100	mA
Forward Current (pw, 1 μs ; 200Hz)	I_F	10	A
Reverse Voltage	V_R	3	V
Power Dissipation ($T_A = 25^\circ\text{C}$) ⁽¹⁾	P_D	170	mW
Power Dissipation ($T_C = 25^\circ\text{C}$) ⁽²⁾	P_D	1.3	W

NOTE:

1. Derate power dissipation linearly 1.70 mW/ $^\circ\text{C}$ above 25 $^\circ\text{C}$ ambient.
2. Derate power dissipation linearly 13.0 mW/ $^\circ\text{C}$ above 25 $^\circ\text{C}$ case.
3. RMA flux is recommended.
4. Methanol or isopropyl alcohols are recommended as cleaning agents.
5. Soldering iron tip 1/16" (1.6mm) minimum from housing.
6. As long as leads are not under any stress or spring tension
7. Total power output, P_O , is the total power radiated by the device into a solid angle of 2π steradians.

ELECTRICAL / OPTICAL CHARACTERISTICS ($T_A = 25^\circ\text{C}$) (All measurements made under pulse conditions)						
PARAMETER	TEST CONDITIONS	SYMBOL	MIN	TYP	MAX	UNITS
Peak Emission Wavelength	$I_F = 100\text{ mA}$	λ_{PE}	—	940	—	nm
Emission Angle at 1/2 Power		Θ	—	± 40	—	Deg.
Forward Voltage	$I_F = 100\text{ mA}$	V_F	—	—	1.7	V
Reverse Leakage Current	$V_R = 3\text{ V}$	I_R	—	—	10	μA
Total Power LED55BF ⁽⁷⁾	$I_F = 100\text{ mA}$	P_O	3.5	—	—	mW
Total Power LED55CF ⁽⁷⁾	$I_F = 100\text{ mA}$	P_O	5.4	—	—	mW
Total Power LED56F ⁽⁷⁾	$I_F = 100\text{ mA}$	P_O	1.5	—	—	mW
Rise Time 0-90% of output		t_r	—	1.0	—	μs
Fall Time 100-10% of output		t_f	—	1.0	—	μs

LED55BF LED55CF LED56F

TYPICAL PERFORMANCE CURVES

Figure 1. Power Output vs. Input Current

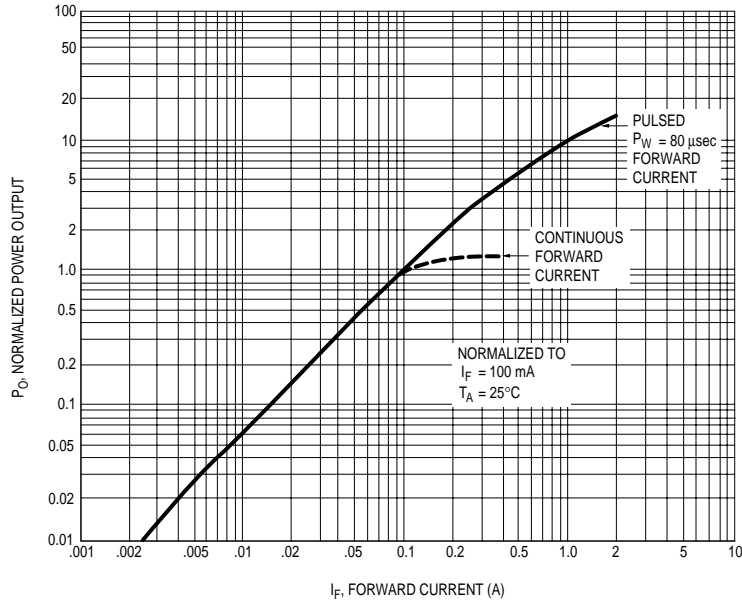

Figure 2. Power Output vs. Temperature

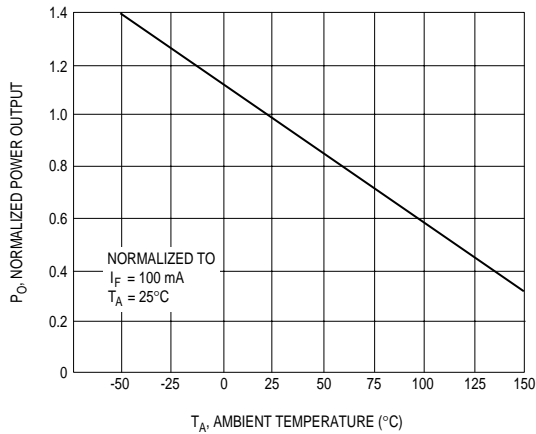

Figure 3. Forward Voltage vs. Forward Current

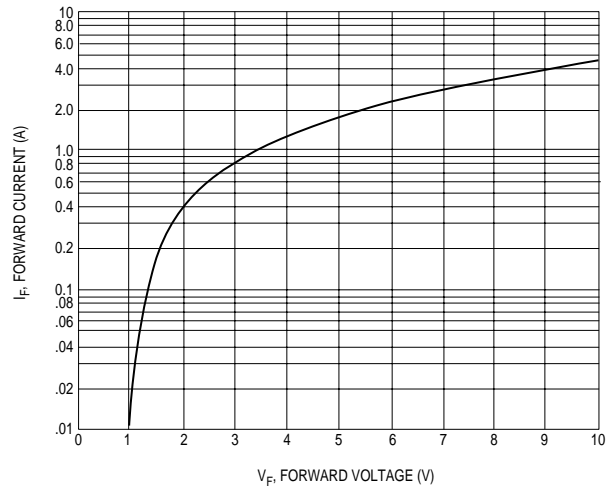

Figure 4. Forward Voltage vs. Forward Current

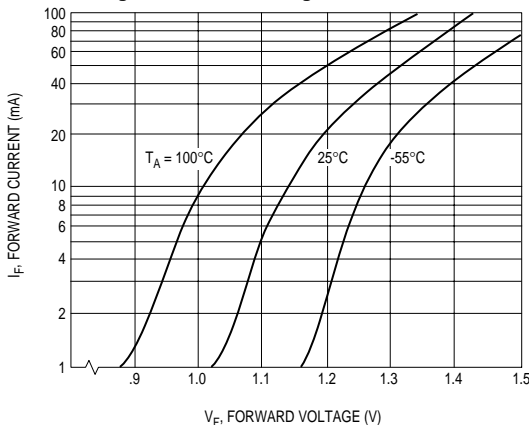
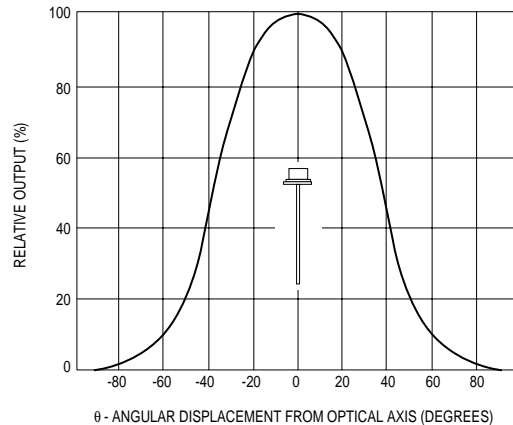

Figure 5. Typical Radiation Pattern



LED55BF LED55CF LED56F

DISCLAIMER

FAIRCHILD SEMICONDUCTOR RESERVES THE RIGHT TO MAKE CHANGES WITHOUT FURTHER NOTICE TO ANY PRODUCTS HEREIN TO IMPROVE RELIABILITY, FUNCTION OR DESIGN. FAIRCHILD DOES NOT ASSUME ANY LIABILITY ARISING OUT OF THE APPLICATION OR USE OF ANY PRODUCT OR CIRCUIT DESCRIBED HEREIN; NEITHER DOES IT CONVEY ANY LICENSE UNDER ITS PATENT RIGHTS, NOR THE RIGHTS OF OTHERS.

LIFE SUPPORT POLICY

FAIRCHILD'S PRODUCTS ARE NOT AUTHORIZED FOR USE AS CRITICAL COMPONENTS IN LIFE SUPPORT DEVICES OR SYSTEMS WITHOUT THE EXPRESS WRITTEN APPROVAL OF THE PRESIDENT OF FAIRCHILD SEMICONDUCTOR CORPORATION. As used herein:

1. Life support devices or systems are devices or systems which, (a) are intended for surgical implant into the body, or (b) support or sustain life, and (c) whose failure to perform when properly used in accordance with instructions for use provided in labeling, can be reasonably expected to result in a significant injury of the user.
2. A critical component in any component of a life support device or system whose failure to perform can be reasonably expected to cause the failure of the life support device or system, or to affect its safety or effectiveness.