

LQ104V1DG61

TFT-LCD Module

Spec. Issue Date: April 3, 2006

No: LD-18316A

PREPARED BY : DATE	SHARP	SPEC No. LD-18316A
APPROVED BY : DATE		FILE No.
		ISSUE : Apr. 3. 2006
		PAGE : 19 pages
	MOBILE LIQUID CRYSTAL DISPLAY GROUP I SHARP CORPORATION	APPLICABLE GROUP MOBILE LIQUID CRYSTAL DISPLAY GROUP I

DEVICE SPECIFICATION FOR
TFT-LCD Module
 MODEL No.
LQ104V1DG61

These parts have corresponded with the RoHS directive.

CUSTOMER'S APPROVAL

DATE _____

BY _____

PRESENTED

BY *T. Naka*

T. NAKA
 Division deputy general manager of
 Mobile LCD design center
 ENGINEERING DEPARTMENT IV
 MOBILE LCD DESIGN CENTER
 MOBILE LIQUID CRYSTAL DISPLAY GROUP I
 SHARP CORPORATION

1. Application

This specification applies to color TFT-LCD module, LQ104V1DG61

These specification sheets are the proprietary product of SHARP CORPORATION("SHARP) and include materials protected under copyright of SHARP. Do not reproduce or cause any third party to reproduce them in any form or by any means, electronic or mechanical, for any purpose, in whole or in part, without the express written permission of SHARP.

The device listed in these specification sheets was designed and manufactured for use in general electronic equipment.

In case of using the device for applications such as control and safety equipment for transportation (controls of aircraft, trains, automobiles, etc.), rescue and security equipment and various safety related equipment which require higher reliability and safety, take into consideration that appropriate measures such as fail-safe functions and redundant system design should be taken.

Do not use the device for equipment that requires an extreme level of reliability, such as aerospace applications, telecommunication equipment (trunk lines), nuclear power control equipment and medical or other equipment for life support.

SHARP assumes no responsibility for any damage resulting from the use of the device which does not comply with the instructions and the precautions specified in these specification sheets.

Contact and consult with a SHARP sales representative for any questions about this device.

2. Overview

This module is a color active matrix LCD module incorporating amorphous silicon TFT (Thin Film Transistor). It is composed of a color TFT-LCD panel, driver ICs, control circuit and power supply circuit and a backlight unit. Graphics and texts can be displayed on a 640×3×480 dots panel with 262,144 colors by supplying 18 bit data signal (6bit/color), four timing signals, +3.3V/5.0V DC supply voltage for TFT-LCD panel driving and supply voltage for backlight.

The TFT-LCD panel used for this module is a low-reflection and higher-color-saturation type.

Therefore, this module is also suitable for the multimedia use. Viewing angle is 6 o'clock direction.

This module is the type of wide viewing angle, superhigh brightness (450cd/m²) and high contrast (600:1).

Backlight-driving DC/AC inverter is not built in this module.

3. Outline specification.

Parameter	Specifications	Unit
Display size	26 (10.4") Diagonal	cm
Active area	211.2(H)×158.4(V)	mm
Pixel format	640(H)×480(V)	pixel
	(1 pixel=R+G+B dots)	-
Number of colors (Number of gray scale level)	262, 144 colors (64 gray scales per color)	
Pixel pitch	0.330(H)×0.330(V)	mm
Pixel configuration	R,G,B vertical stripe	-
Display mode	Normally white	-
Unit outline dimensions *1	246.5(W)×179.4(H)×Max.13.7 (D)	mm
Mass	620 (max)	g
Surface treatment	Anti-glare and hard-coating 3H	-

*1: excluding backlight cables.

Outline dimensions is shown in Fig.1

4. Input Terminals

4-1. TFT-LCD panel driving

CN1 Used connector: DF9MA-31P-1V(32) (Hirose Electric Co., Ltd.)

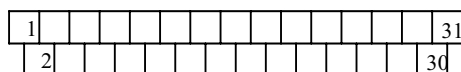

CN1 pin arrangement from module surface
(Transparent view)

Corresponding connector:

DF9-31S-1V(32), DF9A-31S-1V(32),
DF9B-31S-1V(32), DF9C-31S-1V(32)
(Hirose Electric Co., Ltd.)

(※) Please do not use it besides corresponding connector

Pin No.	Symbol	Function	Remark
1	GND	-	
2	CK	Clock signal for sampling each data signal	
3	Hsync	Horizontal synchronous signal	[Note1]
4	Vsync	Vertical synchronous signal	[Note1]
5	GND	-	
6	R0	RED data signal(LSB)	
7	R1	RED data signal	
8	R2	RED data signal	
9	R3	RED data signal	
10	R4	RED data signal	
11	R5	RED data signal(MSB)	
12	GND	-	
13	G0	GREEN data signal(LSB)	
14	G1	GREEN data signal	
15	G2	GREEN data signal	
16	G3	GREEN data signal	
17	G4	GREEN data signal	
18	G5	GREEN data signal(MSB)	
19	GND	-	
20	B0	BLUE data signal(LSB)	
21	B1	BLUE data signal	
22	B2	BLUE data signal	
23	B3	BLUE data signal	
24	B4	BLUE data signal	
25	B5	BLUE data signal(MSB)	
26	GND	-	
27	ENAB	Signal to settle the horizontal display position	[Note2]
28	Vcc	+3.3V / +5.0V power supply	
29	Vcc	+3.3V / +5.0V power supply	
30	R/L	Horizontal display mode select signal	[Note3]
31	U/D	Vertical display mode select signal	[Note4]

※The shielding case is connected with GND.

[Note1] The polarity of both synchronous signals are negative.

[Note2] The horizontal display start timing is settled in accordance with a rising timing of ENAB signal. In case ENAB is fixed "Low", the horizontal start timing is determined as described in 8-2. Don't keep ENAB "High" during operation.

[Note 3],[Note 4]

R/L = High, U/D = Low

R/L = Low, U/D = Low



R/L = High, U/D = High

R/L = Low, U/D = High



4-2. Backlight driving

CN2 ,CN3

Used connector : BHR-02(8.0)VS-1N (JST)

Corresponding connector : SM02(8.0)B-BHS-1-TB or -1N-TB (JST)

Pin no.	symbol	function	Color of FL cable
1	VHIGH	Power supply for lamp (High voltage side)	Pink / Blue
2	VLOW	Power supply for lamp (Low voltage side)	White / Gray

5. Absolute Maximum Ratings

Parameter	Symbol	Condition	Ratings	Unit	Remark
Input voltage	VI	Ta=25°C	-0.3 to Vcc+0.3	V	[Note1]
Lamp input voltage supply voltage	VHIGH Vcc	- Ta=25°C	2000 0 to +6.0	Vrms V	
Storage temperature	Tstg	-	-30 to +80	°C	[Note2]
Operating temperature	Topa	Panel surface	-30 to +80	°C	

[Note1] CK,R0~R5,G0~G5,B0~B5,Hsync,Vsync,ENAB,R/L,U/D

[Note2] Humidity: 95%RH Max. at Ta ≤ 40°C.

Maximum wet-bulb temperature at 39°C or less at Ta > 40°C.

No condensation.

6. Recommended operation condition

Parameter	Symbol	Min.	Typ.	Max.	Unit	Remark
Input voltage	V_I	0		V_{CC}	V	[Note1]
Supply voltage	V_{CC}	+3.0	+3.3/+5.0	+5.5	V	[Note2]
Ambient temperature	T_{opa}	-30		+80	°C	[Note3], [Note4]

[Note1] CK, R0~R5, G0~G5, B0~B5, Hsync, Vsync, ENAB, R/L, U/D

[Note2]

V_{CC}-turn-on conditions

$$0 < t_1 \leq 15\text{ms}$$

$$0 < t_2 \leq 10\text{ms}$$

$$0 < t_3 \leq 100\text{ms}$$

$$0 < t_4 \leq 1\text{s}$$

$$t_5 > 200\text{ms}$$

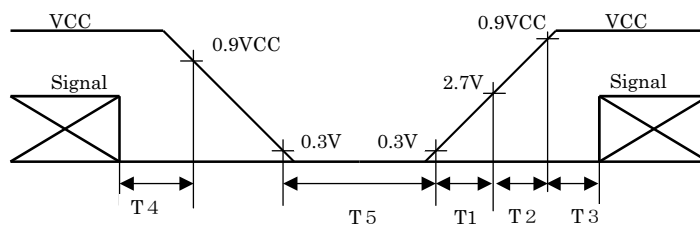

V_{CC}-dip conditions

$$1) \quad 2.5\text{V} \leq V_{CC}$$

$$t_d \leq 10\text{ms}$$

$$2) \quad V_{CC} < 2.5\text{V}$$

V_{CC}-dip conditions should also follow the

V_{CC}-turn-on conditions

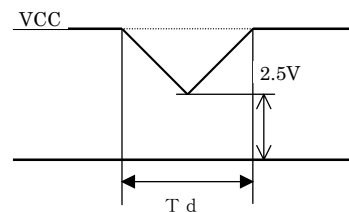

[Note3] Humidity: 95%RH Max. at $T_a \leq 40^\circ\text{C}$.

Maximum wet-bulb temperature at 39°C or less at $T_a > 40^\circ\text{C}$.

No condensation.

[Note4] Maximum value : Panel surface temperature

7. Electrical Characteristics

7-1. TFT-LCD panel driving

Ta=25°C

Parameter		Symbol	Min.	Typ.	Max.	Unit	Remark
Current dissipation	Vcc=3.3V	Icc	-	200	300	mA	[Note1]
	Vcc=5.0V	Icc	-	130	200	mA	
Permissive input ripple voltage		VRP	-	-	100	mVp-p	
Input voltage	Low	VIL	-	-	0.8	V	[Note2]
Input voltage	High	VIH	2.1	-	-	V	
Input current 1	Low(VI=0V)	IOL1	-10.0	-	10.0	μA	[Note3],[Note6]
	Hogh(VI=Vcc)	IOH1	-10.0	-	10.0	μA	
Input current 2	Low(VI=0V)	IOL2	-800	-	-	μA	[Note4],[Note6]
	Hogh(VI=Vcc)	IOH2	-10.0	-	10.0	μA	
Input current 3	Low(VI=0V)	IOL3	-10.0	-	10.0	μA	[Note5],[Note6]
	Hogh(VI=Vcc)	IOH3	-	-	800	μA	

[Note1] Typical current situation : 16-gray-bar pattern.

Vcc=+3.3V/+5.0V

[Note2] CK,R0~R5,G0~G5,B0~B5,Hsync,Vsync,ENAB,
R/L,U/D

[Note3] CK,R0~R5,G0~G5,B0~B5,Hsync,Vsync,ENAB,

[Note4] R/L

[Note5] U/D

[Note6] See below block diagram of input interface.

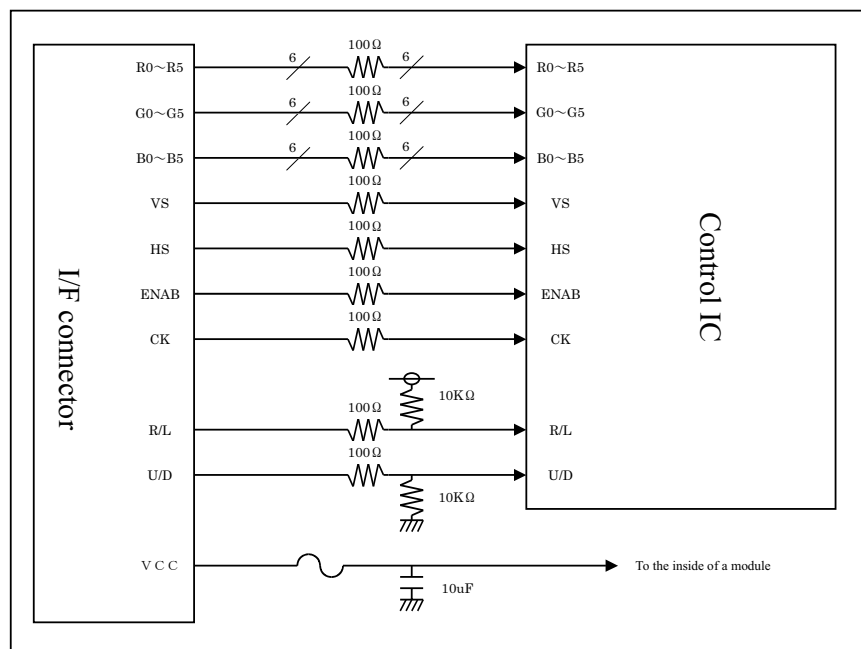
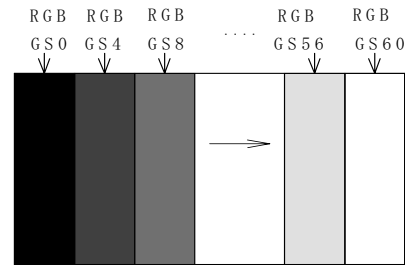

7-2. Backlight driving

The backlight system is an edge-lighting type with double CCFT (Cold Cathode Fluorescent Tube).

The characteristics of single lamp are shown in the following table.

(It is usually required to measure under the following condition.

condition:IL=6.0mA,Ta=25°C±2°C,FL=60kHz.)

Parameter	Symbol	Min.	Typ.	Max.	Unit	Remark
Lamp current	IL	3.0	6.0	6.5	mA rms	[Note1]
Lamp power consumption	PL	-	2.8	-	W	[Note2]
Lamp frequency	FL	35	60	70	kHz	[Note3]
Kick-off voltage	Vs	-	-	1300	V rms	Inverter output
		-	-	(2000)		Transformer output at barast capacitor=12pF
Lamp life time	LL	50000	-	-	Hour	IL=6.0mArms [Note5]
		60000	-	-	Hour	IL=5.0mArms [Note5]

[Note1] Lamp current is measured with current meter for high frequency as shown below.

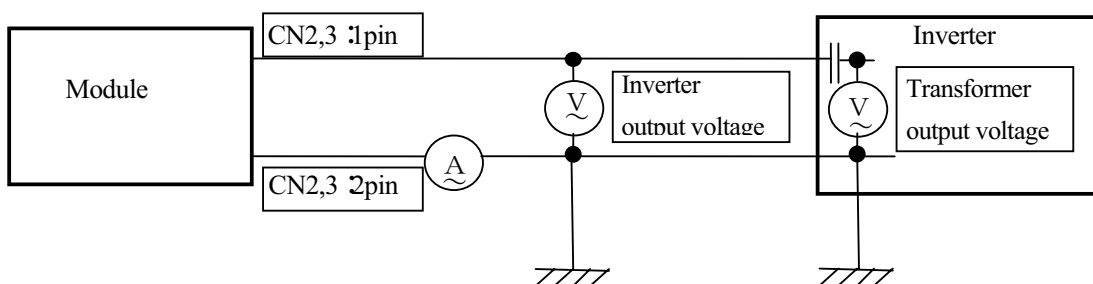

[Note2] Referential data per one CCFT by calculation. ($I_L \times V_L$)

The data don't include loss at inverter. ($I_L=6.0\text{mArms}$)

[Note3] Lamp frequency may produce interference with horizontal synchronous frequency, and this may cause beat on the display. Therefore lamp frequency shall be detached as much as possible from the horizontal synchronous frequency and from the harmonics of horizontal synchronous to avoid interference.

[Note4] The open output voltage of the inverter shall be maintained for more than 1s; otherwise the lamp may not be turned on.

[Note5] Above value is applicable when lamp (the long side of LCD module) is placed horizontally. (Landscape position)

Lamp life time is defined that it applied either ① or ② under this condition
(Continuous turning on at Ta=25°C, IL=6.0mA rms)

① Brightness becomes 50% of the original value under standard condition.

② Kick-off voltage at Ta=-30°C exceeds maximum value, 1300Vrms.

(Lamp lifetime may vary if lamp is in portrait position due to the change of mercury density inside the lamp.)
In case of operating under lower temp environment, the lamp exhaustion is accelerated and the brightness becomes lower.

(Continuous operating for around 1 month under lower temp condition may reduce the brightness to half of the original brightness.)

In case of such usage under lower temp environment, periodical lamp exchange is recommended.

[Note6] The performance of the backlight, for example life time or brightness, is much influenced by the characteristics of the DC-AC inverter for the lamp. When you design or order the inverter, please make sure that a poor lighting caused by the mismatch of the backlight and the inverter (miss-lighting, flicker, etc.) never occur. when you confirm it, the module should be operated in the same condition as it is installed in your instrument.

Be sure to use a back light power supply with the safety protection circuit such as the detection circuit for the excess voltage, excess current and or electric discharge waveform.

Be sure to use the detect circuit by which one side of the CCFT lamps can be controlled independently. Otherwise, when one side of the CCFT is open, the excess current may possibly be applied to the other side of the lamp.

Recommended inverter is "CXA-0454(TDK)".

("CXA-P1212B-WJL(TDK)" is also recommended general temperature condition.)

[Note7] It is required to have the inverter designed so that to allow the impedance deviation of the two CCFT lamps and the capacity deviation of barast capacitor.

[Note8] Under the environment of 10lx or less, miss-lighting delay may occur.

8. Timing Characteristics of input signals

Timing diagrams of input signal are shown in Fig.2.

8-1. Timing characteristics

Parameter		Symbol	Min.	Typ.	Max.	Unit	Remark
Clock	Frequency	1/Tc	23	25.18	28.33	MHz	-
	High time	Tch	5	-	-	ns	-
	Low time	Tcl	10	-	-	ns	-
	Duty ratio	Th/T	40	50	60	%	-
Data	Setup time	Tds	5	-	-	ns	-
	Hold time	Tdh	10	-	-	ns	-
Horizontal sync. signal	Cycle	TH	30.00	31.78	-	μs	-
			750	800	900	clock	-
	Pulse width	THp	2	96	200	clock	-
Vertical sync. signal	Cycle	TV	515	525	560	line	-
	Pulse width	TVp	1	-	34	line	-
Horizontal display period		THd	640	640	640	clock	-
Hsync-Clock phase difference		THc	10	-	Tc-10	ns	-
Hsync-Vsync phase difference		TVh	0	-	TH-THp	clock	-
Vertical data start position		TVs	34	34	34	line	-

[Note] In case of lower frequency, the deterioration of display quality, flicker etc., may be occurred.

8-2. Horizontal display position

The horizontal display position is determined by ENAB signal and the input data corresponding to the rising edge of ENAB signal is displayed at the left end of the active area.

Parameter		symbol	Min.	Typ.	Max.	Unit	Remark
Enable signal	Setup time	Tes	5	-	Tc-10	ns	-
	Pulse width	Tep	2	640	TH-10	clock	-
Hsync-Enable signal phase difference		THE	44	-	TH-664	clock	-

[Note] When ENAB is fixed "Low", the display starts from the data of C104(clock) as shown in Fig.2.

Be careful that the module does not work when ENAB is fixed "High".

When the phase difference is below 104 clock, keep the "High level of ENAB is signal longer than 104-The. If it will not be kept, the display starts from the data of C104(clock).

8-3. Vertical display position

The vertical display position, TVs is fixed "34" (line).

8-4. Input Data Signals and Display Position on the screen

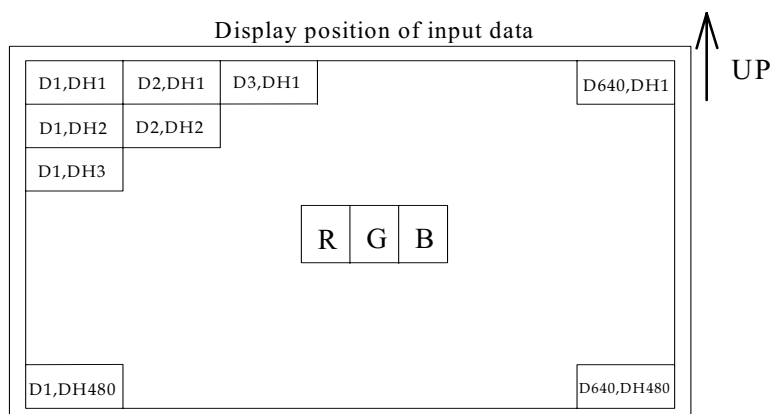

9. Input Signals, Basic Display Colors and Gray Scale of Each Color

Colors & Gray scale	Data signal																			
	Gray Scale	R0	R1	R2	R3	R4	R5	G0	G1	G2	G3	G4	G5	B0	B1	B2	B3	B4	B5	
Basic Color	Black	—	0	0	0	0	0	0	0	0	0	0	0	0	0	0	0	0	0	0
	Blue	—	0	0	0	0	0	0	0	0	0	0	0	0	1	1	1	1	1	1
	Green	—	0	0	0	0	0	0	1	1	1	1	1	1	0	0	0	0	0	0
	Cyan	—	0	0	0	0	0	0	1	1	1	1	1	1	1	1	1	1	1	1
	Red	—	1	1	1	1	1	1	0	0	0	0	0	0	0	0	0	0	0	0
	Magenta	—	1	1	1	1	1	1	0	0	0	0	0	0	1	1	1	1	1	1
	Yellow	—	1	1	1	1	1	1	1	1	1	1	1	1	0	0	0	0	0	0
	White	—	1	1	1	1	1	1	1	1	1	1	1	1	1	1	1	1	1	1
Gray Scale of Red	Black	GS0	0	0	0	0	0	0	0	0	0	0	0	0	0	0	0	0	0	0
	↑	GS1	1	0	0	0	0	0	0	0	0	0	0	0	0	0	0	0	0	0
	Darker	GS2	0	1	0	0	0	0	0	0	0	0	0	0	0	0	0	0	0	0
	↑	↓			↓					↓					↓					
	↓	↓			↓					↓					↓					
	Brighter	GS61	1	0	1	1	1	1	0	0	0	0	0	0	0	0	0	0	0	0
	↓	GS62	0	1	1	1	1	1	0	0	0	0	0	0	0	0	0	0	0	0
	Red	GS63	1	1	1	1	1	1	0	0	0	0	0	0	0	0	0	0	0	0
Gray Scale of Green	Black	GS0	0	0	0	0	0	0	0	0	0	0	0	0	0	0	0	0	0	0
	↑	GS1	0	0	0	0	0	0	1	0	0	0	0	0	0	0	0	0	0	0
	Darker	GS2	0	0	0	0	0	0	0	1	0	0	0	0	0	0	0	0	0	0
	↑	↓			↓					↓					↓					
	↓	↓			↓					↓					↓					
	Brighter	GS61	0	0	0	0	0	0	1	0	1	1	1	1	0	0	0	0	0	0
	↓	GS62	0	0	0	0	0	0	0	1	1	1	1	1	0	0	0	0	0	0
	Green	GS63	0	0	0	0	0	0	1	1	1	1	1	1	0	0	0	0	0	0
Gray Scale of Blue	Black	GS0	0	0	0	0	0	0	0	0	0	0	0	0	0	0	0	0	0	0
	↑	GS1	0	0	0	0	0	0	0	0	0	0	0	0	1	0	0	0	0	0
	Darker	GS2	0	0	0	0	0	0	0	0	0	0	0	0	0	1	0	0	0	0
	↑	↓			↓					↓					↓					
	↓	↓			↓					↓					↓					
	Brighter	GS61	0	0	0	0	0	0	0	0	0	0	0	0	1	0	1	1	1	1
	↓	GS62	0	0	0	0	0	0	0	0	0	0	0	0	0	1	1	1	1	1
	Blue	GS63	0	0	0	0	0	0	0	0	0	0	0	0	1	1	1	1	1	1

0 :Low level voltage, 1 : High level voltage

Each basic color can be displayed in 64 gray scales from 6 bit data signals. According to the combination of total 18 bit data signals, the 262,144-color display can be achieved on the screen.

10. Optical Characteristics

Ta=25°C, Vcc=+3.3V / +5.0V

Parameter		Symbol	Condition	Min.	Typ.	Max.	Unit	Remark
Viewing angle range	Horizontal	θ_{21}, θ_{22}	CR>10	60	70	-	Deg.	[Note1]
	Vertical	θ_{11}		35	50	-	Deg.	[Note4]
		θ_{12}		55	60	-	Deg.	
Contrast ratio		CRn	$\theta = 0^\circ$	300	-	-		[Note2]
		CRo	Optimum viewing angle	-	600	-		[Note4]
Response time	Rise	τ_r	$\theta = 0^\circ$	-	10	-	ms	[Note3]
	Decay	τ_d		-	25	-	ms	[Note4]
Chromaticity of white		x		0.263	0.313	0.363		[Note4] IL=6.0mA rms f=60kHz
		y		0.279	0.329	0.379		
Chromaticity of red		x		0.546	0.596	0.646		
		y		0.279	0.329	0.379		
Chromaticity of green		x		0.260	0.310	0.360		
		y		0.502	0.552	0.602		
Chromaticity of blue		x		0.117	0.167	0.217		
		y		0.132	0.182	0.232		
Luminance of white		Y_{L1}	360	450	-	cd/m ²		
White Uniformity		δW	-	-	1.35		[Note5]	

[Note] The measurement shall be executed 30 minutes after lighting at rating. (condition:IL=6.0mA rms)

The optical characteristics shall be measured in a dark room or equivalent state with the method shown in Fig.3 below.

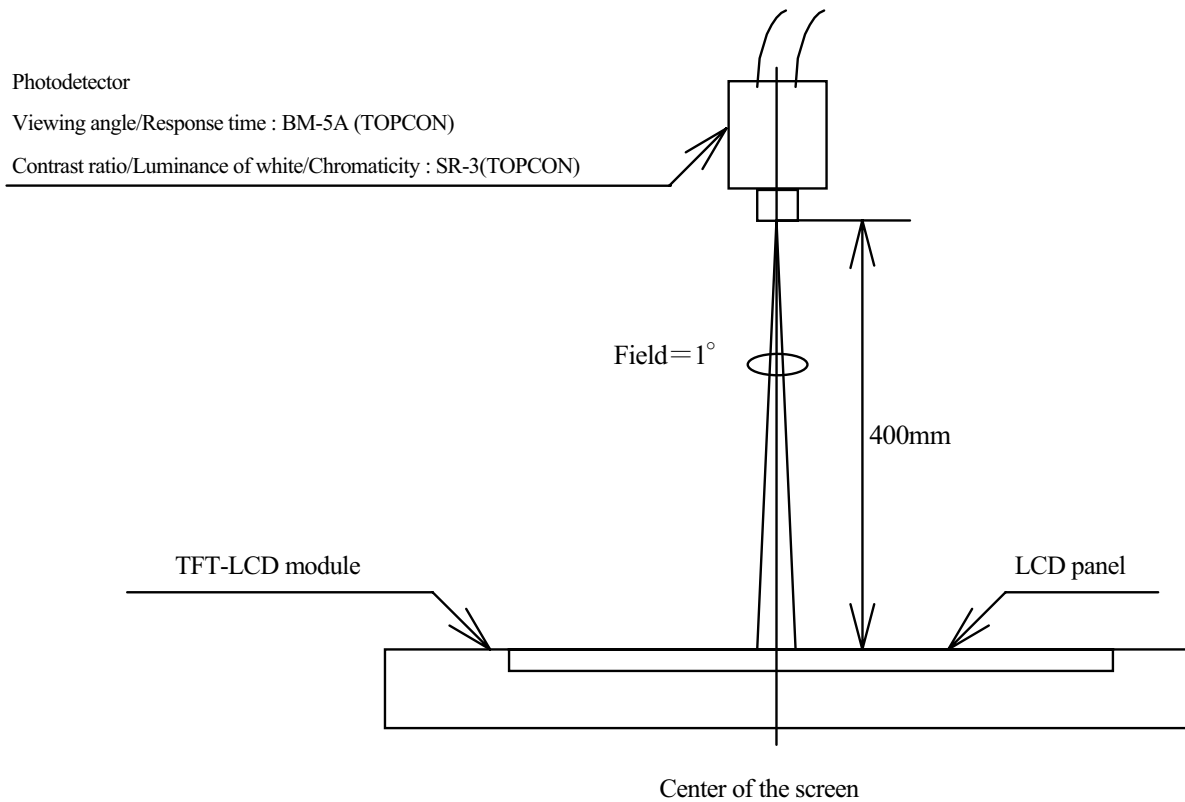
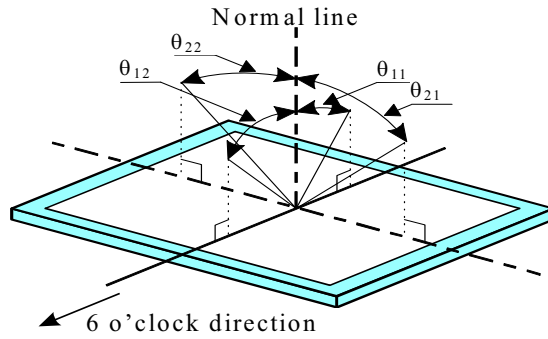

Fig.3 Optical characteristics measurement method

[Note1] Definitions of viewing angle range:



[Note2] Definition of contrast ratio:

The contrast ratio is defined as the following.

$$\text{Contrast Ratio (CR)} = \frac{\text{Luminance (brightness) with all pixels white}}{\text{Luminance (brightness) with all pixels black}}$$

[Note3] Definition of response time:

The response time is defined as the following figure and shall be measured by switching the input signal for "black" and "white".

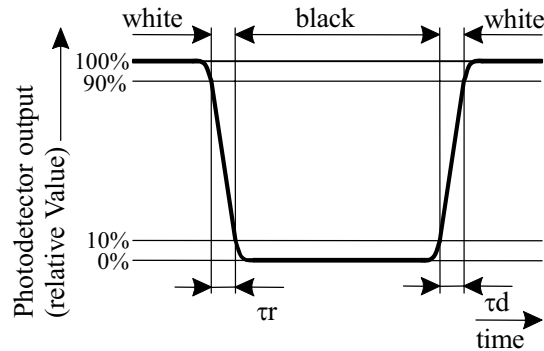

[Note4] This shall be measured at center of the screen.

[Note5] Definition of white uniformity:

White uniformity is defined as the following with five measurements (A~E).

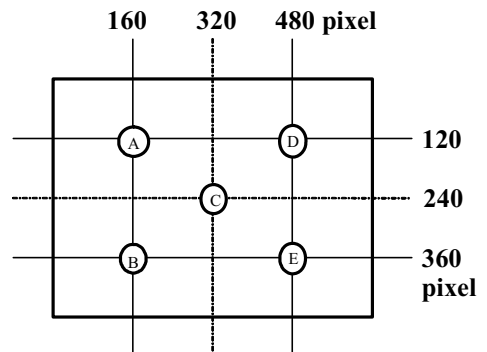

$$\delta_w = \frac{\text{Maximum Luminance of five points (brightness)}}{\text{Minimum Luminance of five points (brightness)}}$$

11. Display Quality

The display quality of the color TFT-LCD module shall be in compliance with the Incoming Inspection Standard.

12. Handling Precautions

- a) Be sure to turn off the power supply when inserting or disconnecting the cable.
- b) Be sure to design the cabinet so that the module can be installed without any extra stress such as warp or twist.
- c) Since the front polarizer is easily damaged, pay attention not to scratch it.
Blow away dust on the polarizer with antistatic N_2 blow. It is undesirable to wipe off because a polarizer is sensitive. It is recommended to peel off softly using the adhesive tape when soil or finger oil is stuck to the polarizer. When unavoidable, wipe off carefully with a cloth for wiping lenses.
- d) Wipe off water drop immediately. Long contact with water may cause discoloration or spots.
- e) When the panel surface is soiled, wipe it with absorbent cotton or other soft cloth.
- f) Since the panel is made of glass, it may break or crack if dropped or bumped on hard surface.
Handle with care.
- g) Since CMOS LSI is used in this module, take care of static electricity and injure the human earth when handling. Observe all other precautionary requirements in handling components.
- h) Since there is a circuit board in the module back, stress is not added at the time of a design assembly. Please make it like. If stress is added, there is a possibility that circuit parts may be damaged.
- i) Protection film is attached to the module surface to prevent it from being scratched .
Peel the film off slowly , just before the use, with strict attention to electrostatic charges.
Blow off 'dust' on the polarizer by using an ionized nitrogen.
- j) The polarizer surface on the panel is treated with Anti-Glare for low reflection. In case of attaching protective board over the LCD, be careful about the optical interface fringe etc. which degrades display quality.
- k) Do not expose the LCD panel to direct sunlight. Lightproof shade etc. should be attached when LCD panel is used under such environment.
- l) Connect GND to 4 place of mounting holes to stabilize against EMI and external noise.
- m) There are high voltage portions on the backlight and very dangerous. Careless touch may lead to electrical shock. When exchange lamps or service, turn off the power without fail.
- n) When handling LCD modules and assembling them into cabinets, please be noted that long-term storage in the environment of oxidization or deoxidization gas and the use of such materials as reagent, solvent, adhesive, resin, etc. which generate these gasses, may cause corrosion and discoloration of the LCD modules.
- o) Cold cathode fluorescent lamp in LCD panel contains a small amount of mercury, please follow local ordinances or regulations for disposal.
- p) Be careful of a back light lead not to pull by force at the time of the wiring to an inverter, or line processing.
- q) When install LCD modules in the cabinet, recommended torque value is " $0.294 \pm 0.02 N \cdot m$ ($3.0 \pm 0.2 kgf \cdot cm$)".
Be sure to confirm it in the same condition as it is installed in your instrument.
- r) Liquid crystal contained in the panel may leak if the LCD is broken. Rinse it as soon as possible if it gets inside your eye or mouth by mistake.
- s) Notice: Never dismantle the module , because it will cause failure.
- t) Be careful when using it for long time with fixed pattern display as it may cause afterimage.
- u) Adjusting volume have been set optimally before shipment, so do not change any adjusted value.
If adjusted value is changed, the specification may not be satisfied.
- v) If a minute particle enters in the module and adheres to an optical material, it may cause display non-uniformity issue, etc. Therefore, fine-pitch filters have to be installed to cooling and inhalation hole if you intend to install a fan.

13. Packing form

Product countries / Areas	JAPAN	TAIWAN	CHINA
Piling number of cartons	6		
Package quantity in one carton	10pcs		
Carton size	395(L)×310(W)×270(H)		
Total mass of one carton filled with full modules	8,000g		
Packing form is shown	Fig4		

14. Reliability test items

No.	Test item	Conditions	Remark
1	High temperature storage test	Ta=80°C 240h	Panel surface
2	Low temperature storage test	Ta= -30°C 240h	
3	High temperature & high humidity operation test	Ta=40°C ; 95%RH 240h (No condensation)	
4	High temperature operation test	Ta=80°C 240h	Panel surface
5	Low temperature operation test	Ta= -30°C 240h	
6	Vibration test (non- operating)	Frequency: 10~57Hz/Vibration width (one side): 0.153mm : 57~500Hz/Gravity: 14.7 m/s ² Sweep time : 11 minutes Test period : 3 hours (1 hour for each direction of X,Y,Z)	
7	Shock test (non- operating)	Max. gravity : 490m/s ² Pulse width : 11ms, half sine wave Direction : ±X, ±Y, ±Z once for each direction.	
8	ESD test	Human model	
9	EMI	VCCI (Class B)	

[Result Evaluation Criteria]

Under the display quality test conditions with normal operation state, these shall be no change which may affect practical display function. (normal operation state : Temperature:15~35°C, Humidity:45~75%, Atmospheric pressure:86~106kpa)

15.Others

15-1 Lot No. Label:

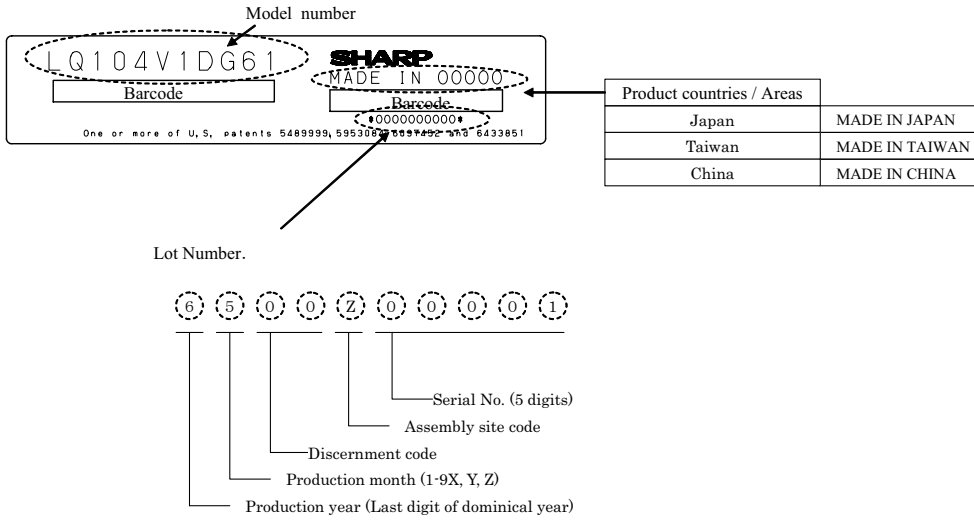

15-2 Packing box Label:

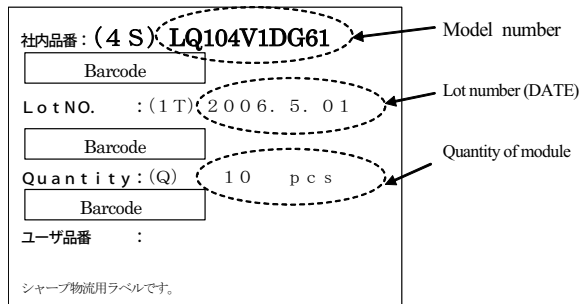

15-3 If any problem occurs in relation to the description of this specification, it shall be resolved through discussion with spirit of cooperation.

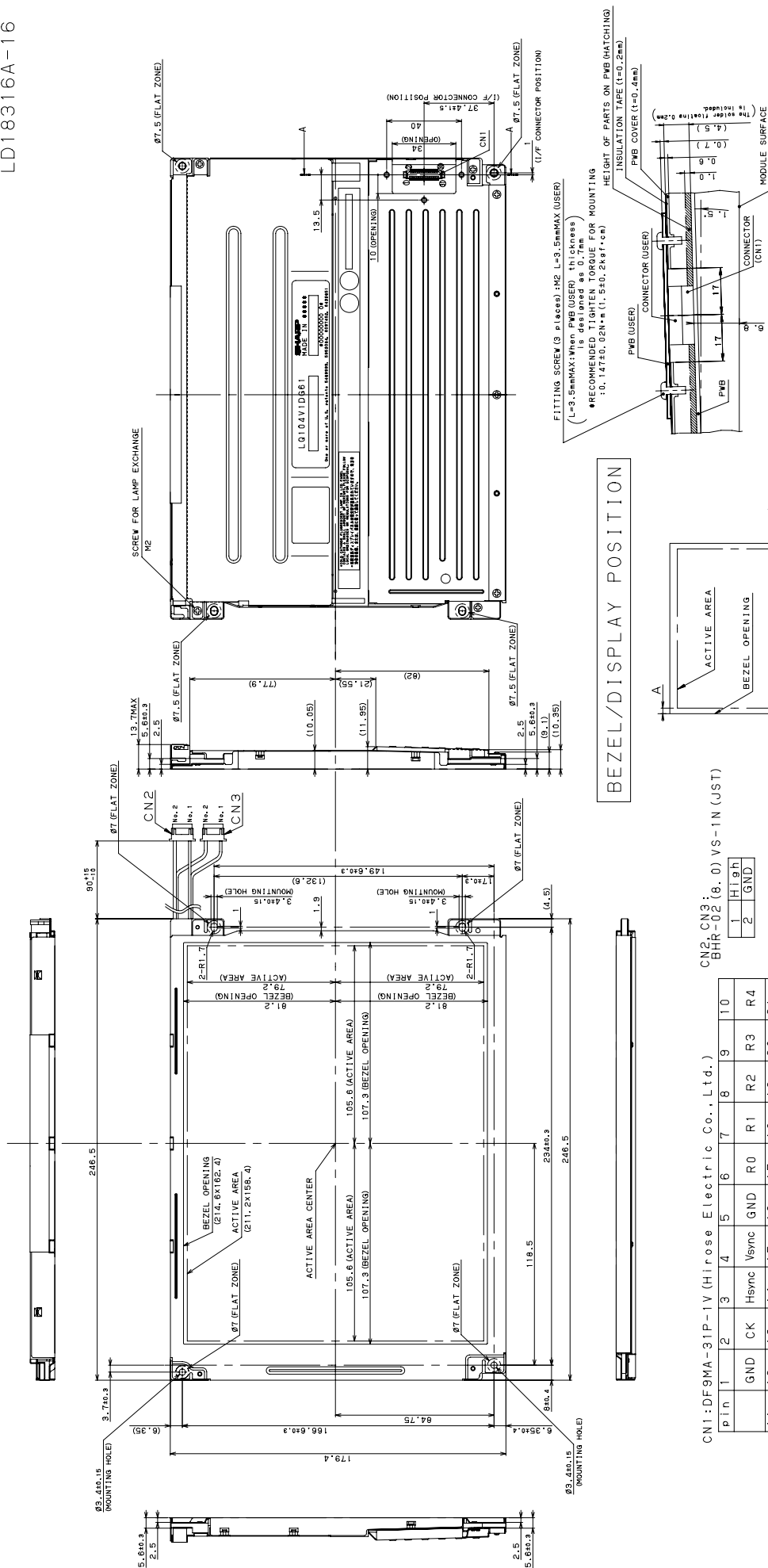

SECTION A-A

- NOTES
- 1) UNSPECIFIED TOLERANCE TO BE ± 0.5
 - 2) WARP AND FLOATING FOR PRINTED WIRING BOARD AND CHASSIS ARE EXCLUDED FROM THE THICKNESS OF THE UNIT
 - 3) FRONT SIDE: REGARDING THE SIZE OF USER'S BOSSES, PLEASE DESIGN THEM FROM $\phi 6\text{mm}$ TO $\phi 7\text{mm}$.
 - 4) REAR SIDE: REGARDING THE SIZE OF USER'S BOSSES, PLEASE DESIGN THEM FROM $\phi 6\text{mm}$ TO $\phi 7.5\text{mm}$.
 - 5) RECOMMENDED TIGHTEN TORQUE FOR MOUNTING $0.294 \pm 0.02\text{N} \cdot \text{m}$ ($3.0 \pm 0.2\text{kgf} \cdot \text{cm}$)

- 1) TOLERANCE X-DIRECTION $A: 1.7 \pm 0.8$
- 2) TOLERANCE Y-DIRECTION $B: 2.0 \pm 0.8$
- 3) OBLIQUITY OF DISPLAY AREA $|C-D| < 0.8$

CN2, CN3: BHR-02 (8, 0) VS-1N (JST)

1	High
2	GND

CN1: DF9MA-31P-1V (Hirose Electric Co., Ltd.)

pin	1	2	3	4	5	6	7	8	9	10
GND	CK	Hsync	GND	R0	R1	R2	R3	R4		
11	12	13	14	15	16	17	18	19	20	21
R5	GND	G0	G1	G2	G3	G4	G5	GND	B0	B1
22	23	24	25	26	27	28	29	30	31	
B2	B3	B4	B5	GND	ENAB	Vcc	Vcc	R/L	U/D	

CORRESPONDING CONNECTOR: DF9-31S-1V, DF9A-31S-1V, DF9B-31S-1V, DF9C-31S-1V

Fig 1. LQ104V1DG61 OUTLINE DIMENSIONS

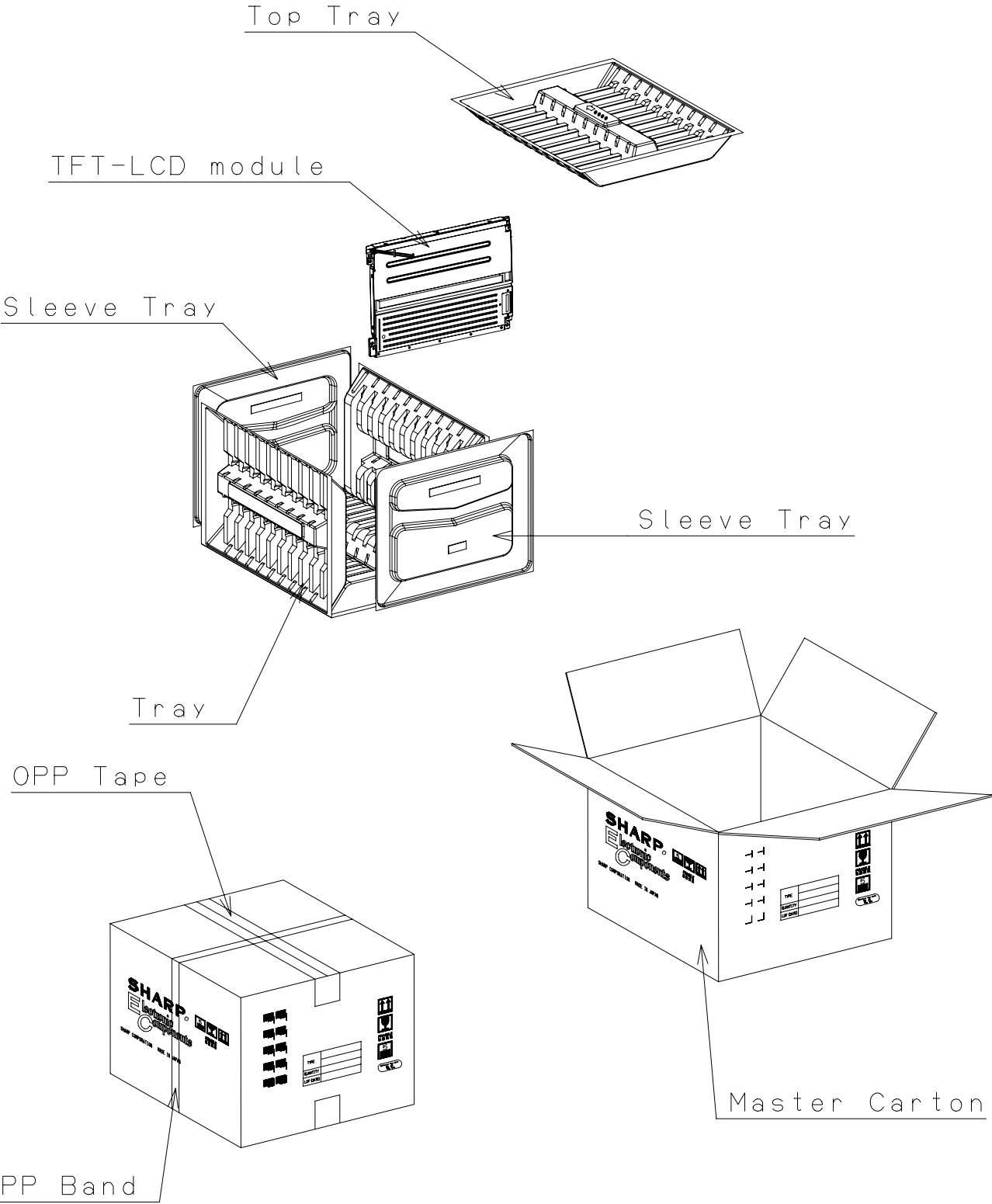

Fig4. PACKING FORM

NOTICE

This publication is the proprietary of SHARP and is copyrighted, with all rights reserved. Under the copyright laws, no part of this publication may be reproduced or transmitted in any form or by any means, electronic or mechanical for any purpose, in whole or in part, without the express written permission of SHARP. Express written permission is also required before any use of this publication may be made by a third party.

The application circuit examples in this publication are provided to explain the representative applications of SHARP's devices and are not intended to guarantee any circuit design or permit any industrial property right or other rights to be executed. SHARP takes no responsibility for any problems related to any industrial property right or a third party resulting from the use of SHARP's devices, except for those resulting directly from device manufacturing processes.

In the absence of confirmation by device specification sheets, SHARP takes no responsibility for any defects that occur in equipment using any of SHARP's devices, shown in catalogs, data books, etc. Contact SHARP in order to obtain the latest device specification sheets before using any SHARP's device.

SHARP reserves the right to make changes in the specifications, characteristics, data, materials, structures and other contents described herein at any time without notice in order to improve design or reliability. Contact SHARP in order to obtain the latest specification sheets before using any SHARP's device. Manufacturing locations are also subject to change without notice.

Observe the following points when using any device in this publication. SHARP takes no responsibility for damage caused by improper use *of the devices*.

The appropriate design measures should be taken to ensure reliability and safety when SHARP's devices are used for equipment such as:

- Transportation control and safety equipment (i.e., aircraft, trains, automobiles, etc.)
- Traffic signals
- Alarm equipment
- Gas leakage sensor breakers
- Various safety devices etc.

SHARP's devices shall not be used for equipment that requires extremely high level of reliability, such as:

- Military and space applications
- Medical equipment for life support
- Nuclear power control equipment

Contact a SHARP representative, in advance, when intending to use SHARP's devices for any "specific" applications other than those recommended by SHARP.

Contact and consult with a SHARP representative if there are any questions about the contents of this publication.

SPECIFICATIONS ARE SUBJECT TO CHANGE WITHOUT NOTICE.

Suggested applications (if any) are for standard use; See Important Restrictions for limitations on special applications. See Limited Warranty for SHARP's product warranty. The Limited Warranty is in lieu, and exclusive of, all other warranties, express or implied. ALL EXPRESS AND IMPLIED WARRANTIES, INCLUDING THE WARRANTIES OF MERCHANTABILITY, FITNESS FOR USE AND FITNESS FOR A PARTICULAR PURPOSE, ARE SPECIFICALLY EXCLUDED. In no event will SHARP be liable, or in any way responsible, for any incidental or consequential economic or property damage.

SHARP®

NORTH AMERICA

SHARP Microelectronics of the Americas
5700 NW Pacific Rim Blvd.
Camas, WA 98607, U.S.A.
Phone: (1) 360-834-2500
Fax: (1) 360-834-8903
Fast Info: (1) 800-833-9437
www.sharpsma.com

EUROPE

SHARP Microelectronics Europe
Division of Sharp Electronics (Europe) GmbH
Sonninstrasse 3
20097 Hamburg, Germany
Phone: (49) 40-2376-2286
Fax: (49) 40-2376-2232
www.sharpsme.com

JAPAN

SHARP Corporation
Electronic Components & Devices
22-22 Nagaike-cho, Abeno-Ku
Osaka 545-8522, Japan
Phone: (81) 6-6621-1221
Fax: (81) 6117-725300/6117-725301
www.sharp-world.com

TAIWAN

SHARP Electronic Components
(Taiwan) Corporation
8F-A, No. 16, Sec. 4, Nanking E. Rd.
Taipei, Taiwan, Republic of China
Phone: (886) 2-2577-7341
Fax: (886) 2-2577-7326/2-2577-7328

SINGAPORE

SHARP Electronics (Singapore) PTE., Ltd.
438A, Alexandra Road, #05-01/02
Alexandra Technopark,
Singapore 119967
Phone: (65) 271-3566
Fax: (65) 271-3855

KOREA

SHARP Electronic Components
(Korea) Corporation
RM 501 Geosung B/D, 541
Dohwa-dong, Mapo-ku
Seoul 121-701, Korea
Phone: (82) 2-711-5813 ~ 8
Fax: (82) 2-711-5819

CHINA

SHARP Microelectronics of China
(Shanghai) Co., Ltd.
28 Xin Jin Qiao Road King Tower 16F
Pudong Shanghai, 201206 P.R. China
Phone: (86) 21-5854-7710/21-5834-6056
Fax: (86) 21-5854-4340/21-5834-6057

Head Office:

No. 360, Bashen Road,
Xin Development Bldg. 22
Waigaoqiao Free Trade Zone Shanghai
200131 P.R. China
Email: smc@china.global.sharp.co.jp

HONG KONG

SHARP-ROXY (Hong Kong) Ltd.
3rd Business Division,
17/F, Admiralty Centre, Tower 1
18 Harcourt Road, Hong Kong
Phone: (852) 28229311
Fax: (852) 28660779
www.sharp.com.hk

Shenzhen Representative Office:

Room 13B1, Tower C,
Electronics Science & Technology Building
Shen Nan Zhong Road
Shenzhen, P.R. China
Phone: (86) 755-3273731
Fax: (86) 755-3273735