

10kHz to 10MHz, Low Power Crystal Oscillator

The HA7210 is a very low power crystal-controlled oscillators that can be externally programmed to operate between 10kHz and 10MHz. For normal operation it requires only the addition of a crystal. The part exhibits very high stability over a wide operating voltage and temperature range.

The HA7210 also features a disable mode that switches the output to a high impedance state. This feature is useful for minimizing power dissipation during standby and when multiple oscillator circuits are employed.

Ordering Information

PART NUMBER (BRAND)	TEMP. RANGE (°C)	PACKAGE	PKG. NO.
HA7210IP	-40 to 85	8 Ld PDIP	E8.3
HA7210IB (H7210I)	-40 to 85	8 Ld SOIC	M8.15
HA7210Y	-40 to 85	DIE	

Pinout

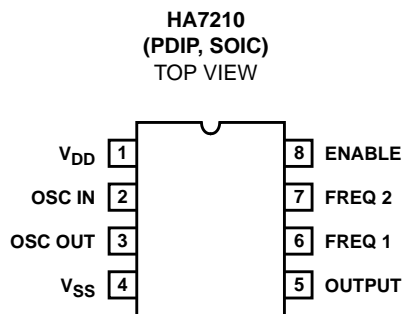

Features

- Single Supply Operation at 32kHz 2V to 7V
- Operating Frequency Range 10kHz to 10MHz
- Supply Current at 32kHz 5µA
- Supply Current at 1MHz 130µA
- Drives 2 CMOS Loads
- Only Requires an External Crystal for Operation

Applications

- Battery Powered Circuits
- Remote Metering
- Embedded Microprocessors
- Palm Top/Notebook PC
- Related Literature
 - AN9334, Improving HA7210 Start-Up Time

Typical Application Circuit

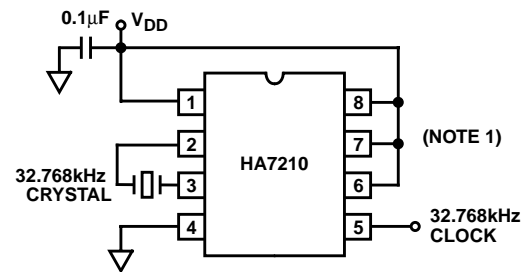

32.768kHz MICROPOWER CLOCK OSCILLATOR

NOTE:

1. Internal pull-up resistors provided on EN, FREQ1, and FREQ2 inputs.

Simplified Block Diagram

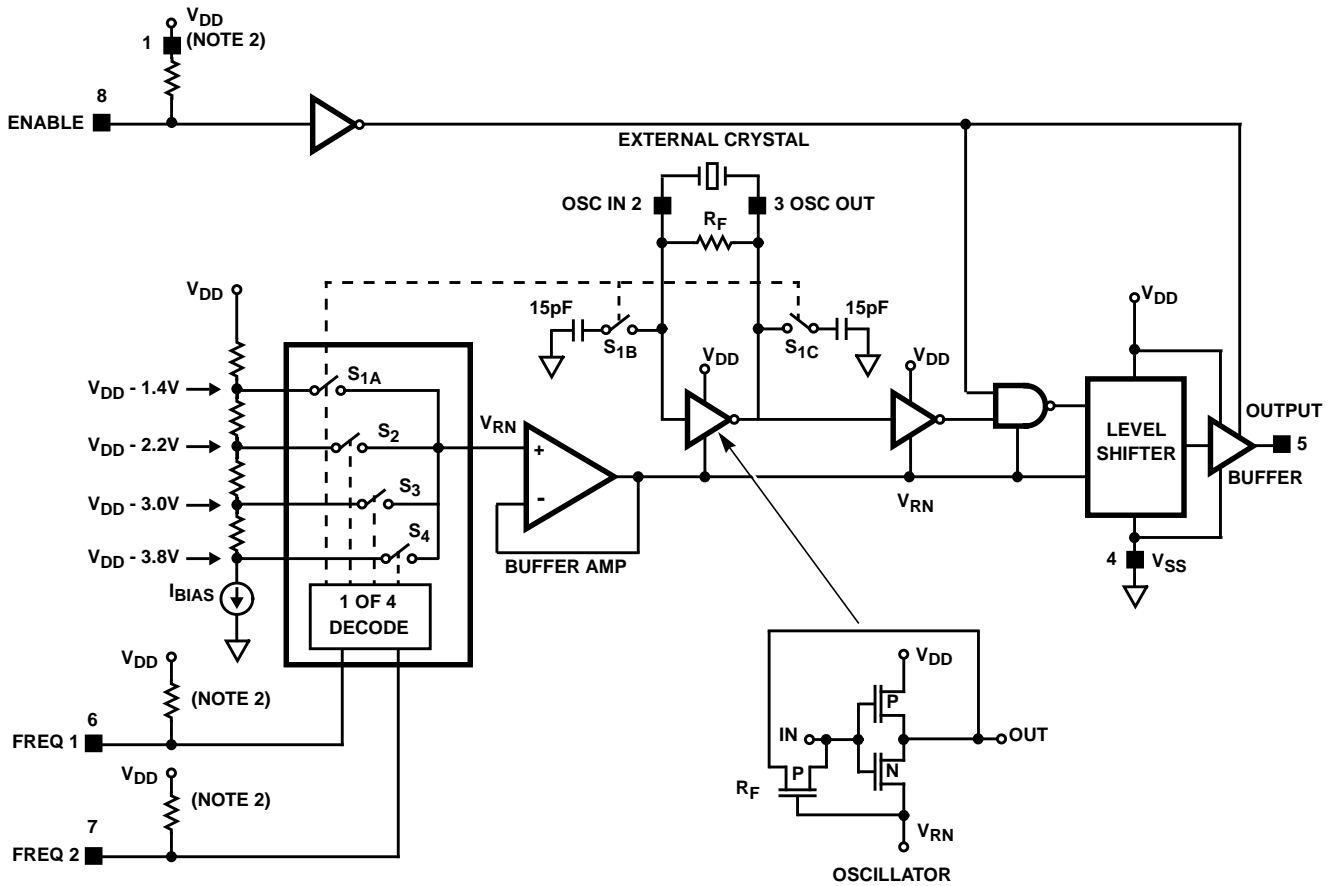

FREQUENCY SELECTION TRUTH TABLE

ENABLE	FREQ 1	FREQ 2	SWITCH	OUTPUT RANGE
1	1	1	S _{1A} , S _{1B} , S _{1C}	10kHz - 100kHz
1	1	0	S ₂	100kHz - 1MHz
1	0	1	S ₃	1MHz - 5MHz
1	0	0	S ₄	5MHz - 10MHz+
0	X	X	X	High Impedance

NOTE:

2. Logic input pull-up resistors are constant current source of 0.4μA.

Absolute Maximum Ratings

Supply Voltage 10V
 Voltage (Any Pin) $V_{SS} - 0.3V$ to $V_{DD} + 0.3V$
 ESD Rating
 Human Body Model (Per MIL-STD-883 Method 3015.7) . . . 4000V

Thermal Information

Thermal Resistance (Typical, Note 4) θ_{JA} (°C/W)
 PDIP Package 125
 SOIC Package 170
 Maximum Junction Temperature (Plastic Package) 150°C
 Maximum Storage Temperature Range -65°C to 150°C
 Maximum Lead Temperature (Soldering 10s) 300°C
 (SOIC - Lead Tips Only)

Operating Conditions

Temperature Range (Note 3) -40°C to 85°C

CAUTION: Stresses above those listed in "Absolute Maximum Ratings" may cause permanent damage to the device. This is a stress only rating and operation of the device at these or any other conditions above those indicated in the operational sections of this specification is not implied.

NOTES:

3. This product is production tested at 25°C only.
4. θ_{JA} is measured with the component mounted on an evaluation PC board in free air.

Electrical Specifications $V_{SS} = GND, T_A = 25^\circ C$, Unless Otherwise Specified

PARAMETER	TEST CONDITIONS	$V_{DD} = 5V$			$V_{DD} = 3V$			UNITS
		MIN	TYP	MAX	MIN	TYP	MAX	
V_{DD} Supply Range	$f_{OSC} = 32kHz$	2	5	7	-	-	-	V
I_{DD} Supply Current	$f_{OSC} = 32kHz, EN = 0$ (Standby)	-	5.0	9.0	-	-	-	μA
	$f_{OSC} = 32kHz, C_L = 10pF$ (Note 5), $EN = 1, Freq1 = 1, Freq2 = 1$	-	5.2	10.2	-	3.6	6.1	μA
	$f_{OSC} = 32kHz, C_L = 40pF, EN = 1,$ $Freq1 = 1, Freq2 = 1$	-	10	15	-	6.5	9	μA
	$f_{OSC} = 1MHz, C_L = 10pF$ (Note 5), $EN = 1, Freq1 = 0, Freq2 = 1$	-	130	200	-	90	180	μA
	$f_{OSC} = 1MHz, C_L = 40pF, EN = 1,$ $Freq1 = 0, Freq2 = 1$	-	270	350	-	180	270	μA
V_{OH} Output High Voltage	$I_{OUT} = -1mA$	4.0	4.9	-	-	2.8	-	V
V_{OL} Output Low Voltage	$I_{OUT} = 1mA$	-	0.07	0.4	-	0.1	-	V
I_{OH} Output High Current	$V_{OUT} \geq 4V$	-	-10	-5	-	-	-	mA
I_{OL} Output Low Current	$V_{OUT} \leq 0.4V$	5.0	10.0	-	-	-	-	mA
Three-State Leakage Current	$V_{OUT} = 0V, 5V, T_A = 25^\circ C, -40^\circ C$	-	0.1	-	-	-	-	nA
	$V_{OUT} = 0V, 5V, T_A = 85^\circ C$	-	10	-	-	-	-	nA
I_{IN} Enable, Freq1, Freq2 Input Current	$V_{IN} = V_{SS}$ to V_{DD}	-	0.4	1.0	-	-	-	μA
V_{IH} Input High Voltage Enable, Freq1, Freq2		2.0	-	-	-	-	-	V
V_{IL} Input Low Voltage Enable, Freq1, Freq2		-	-	0.8	-	-	-	V
Enable Time	$C_L = 18pF, R_L = 1k\Omega$	-	800	-	-	-	-	ns
Disable Time	$C_L = 18pF, R_L = 1k\Omega$	-	90	-	-	-	-	ns
t_r Output Rise Time	10% - 90%, $f_{OSC} = 32kHz, C_L = 40pF$	-	12	25	-	12	-	ns
t_f Output Fall Time	10% - 90%, $f_{OSC} = 32kHz, C_L = 40pF$	-	12	25	-	14	-	ns
Duty Cycle, Packaged Part Only (Note 6)	$C_L = 40pF, f_{OSC} = 1MHz$	40	54	60	-	-	-	%
Duty Cycle, (See Typical Curves)	$C_L = 40pF, f_{OSC} = 32kHz$	-	41	-	-	44	-	%
Frequency Stability vs Supply Voltage	$f_{OSC} = 32kHz, V_{DD} = 5V, C_L = 10pF$	-	1	-	-	-	-	ppm/V
Frequency Stability vs Temperature	$f_{OSC} = 32kHz, V_{DD} = 5V, C_L = 10pF$	-	0.1	-	-	-	-	ppm/°C
Frequency Stability vs Load	$f_{OSC} = 32kHz, V_{DD} = 5V, C_L = 10pF$	-	0.01	-	-	-	-	ppm/pF

NOTES:

5. Calculated using the equation $I_{DD} = I_{DD}(\text{No Load}) + (V_{DD})(f_{OSC})(C_L)$
6. Duty cycle will vary with supply voltage, oscillation frequency, and parasitic capacitance on the crystal pins.

Test Circuit

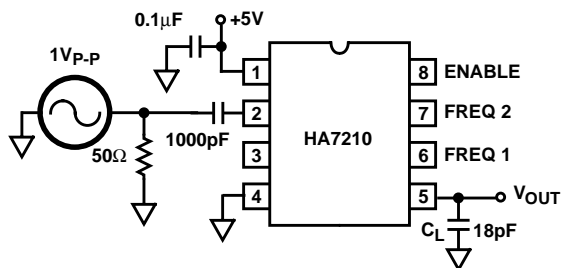

FIGURE 1.

In production the HA7210 is tested with a 32kHz and a 1MHz crystal. However for characterization purposes data was taken using a sine wave generator as the frequency determining element, as shown in Figure 1. The 1V_{p-p} input is a smaller amplitude than what a typical crystal would generate so the transitions are slower. In general the Generator data will show a “worst case” number for I_{DD}, duty cycle, and rise/fall time. The Generator test method is useful for testing a variety of frequencies quickly and provides curves which can be used for understanding performance trends. Data for the HA7210 using crystals has also been taken. This data has been overlaid onto the generator data to provide a reference for comparison.

Application Information

Theory Of Operation

The HA7210 is a Pierce Oscillator optimized for low power consumption, requiring no external components except for a bypass capacitor and a Parallel Mode Crystal. The Simplified Block Diagram shows the Crystal attached to pins 2 and 3, the Oscillator input and output. The crystal drive circuitry is detailed showing the simple CMOS inverter stage and the P-channel device being used as biasing resistor R_F. The inverter will operate mostly in its linear region increasing the amplitude of the oscillation until limited by its transconductance and voltage rails, V_{DD} and V_{RN}. The inverter is self biasing using R_F to center the oscillating waveform at the input threshold. Do not interfere with this bias function with external loads or excessive leakage on pin 2. Nominal value for R_F is 17MΩ in the lowest frequency range to 7MΩ in the highest frequency range.

The HA7210 optimizes its power for 4 frequency ranges selected by digital inputs Freq1 and Freq2 as shown in the Block Diagram. Internal pull up resistors (constant current 0.4μA) on Enable, Freq1 and Freq2 allow the user simply to leave one or all digital inputs not connected for a corresponding “1” state. All digital inputs may be left open for 10kHz to 100kHz operation.

A current source develops 4 selectable reference voltages through series resistors. The selected voltage, V_{RN}, is buffered and used as the negative supply rail for the oscillator section of the circuit. The use of a current source in the reference string allows for wide supply variation with minimal effect on performance. The reduced operating

voltage of the oscillator section reduces power consumption and limits transconductance and bandwidth to the frequency range selected. For frequencies at the edge of a range, the higher range may provide better performance.

The OSC OUT waveform on pin 3 is squared up through a series of inverters to the output drive stage. The Enable function is implemented with a NAND gate in the inverter string, gating the signal to the level shifter and output stage. Also during Disable the output is set to a high impedance state useful for minimizing power during standby and when multiple oscillators are OR'ed to a single node.

Design Considerations

The low power CMOS transistors are designed to consume power mostly during transitions. Keeping these transitions short requires a good decoupling capacitor as close as possible to the supply pins 1 and 4. A ceramic 0.1μF is recommended. Additional supply decoupling on the circuit board with 1μF to 10μF will further reduce overshoot, ringing and power consumption. The HA7210, when compared to a crystal and inverter alone, will speed clock transition times, reducing power consumption of all CMOS circuitry run from that clock.

Power consumption may be further reduced by minimizing the capacitance on moving nodes. The majority of the power will be used in the output stage driving the load. Minimizing the load and parasitic capacitance on the output, pin 5, will play the major role in minimizing supply current. A secondary source of wasted supply current is parasitic or crystal load capacitance on pins 2 and 3. The HA7210 is designed to work with most available crystals in its frequency range with no external components required. Two 15pF capacitors are internally switched onto crystal pins 2 and 3 on the HA7210 to compensate the oscillator in the 10kHz to 100kHz frequency range.

The supply current of the HA7210 may be approximately calculated from the equation:

$$I_{DD} = I_{DD}(\text{Disabled}) + V_{DD} \times f_{OSC} \times C_L \text{ where:}$$

$$I_{DD} = \text{Total supply current}$$

$$V_{DD} = \text{Total voltage from } V_{DD} \text{ (pin 1) to } V_{SS} \text{ (pin 4)}$$

$$f_{OSC} = \text{Frequency of Oscillation}$$

$$C_L = \text{Output (pin 5) load capacitance}$$

EXAMPLE #1:

$$V_{DD} = 5V, f_{OSC} = 100\text{kHz}, C_L = 30\text{pF}$$

$$I_{DD}(\text{Disabled}) = 4.5\mu\text{A (Figure 10)}$$

$$I_{DD} = 4.5\mu\text{A} + (5V)(100\text{kHz})(30\text{pF}) = 19.5\mu\text{A}$$

$$\text{Measured } I_{DD} = 20.3\mu\text{A}$$

EXAMPLE #2:

$$V_{DD} = 5V, f_{OSC} = 5\text{MHz}, C_L = 30\text{pF}$$

$$I_{DD}(\text{Disabled}) = 75\mu\text{A (Figure 9)}$$

$$I_{DD} = 75\mu\text{A} + (5V)(5\text{MHz})(30\text{pF}) = 825\mu\text{A}$$

$$\text{Measured } I_{DD} = 809\mu\text{A}$$

Crystal Selection

For general purpose applications, a Parallel Mode Crystal is a good choice for use with the HA7210. However for applications where a precision frequency is required, the designer needs to consider other factors.

Crystals are available in two types or modes of oscillation, Series and Parallel. Series Mode crystals are manufactured to operate at a specified frequency with zero load capacitance and appear as a near resistive impedance when oscillating. Parallel Mode crystals are manufactured to operate with a specific capacitive load in series, causing the crystal to operate at a more inductive impedance to cancel the load capacitor. Loading a crystal with a different capacitance will "pull" the frequency off its value.

The HA7210 has 4 operating frequency ranges. The higher three ranges do not add any loading capacitance to the oscillator circuit. The lowest range, 10kHz to 100kHz, automatically switches in two 15pF capacitors onto OSC IN and OSC OUT to eliminate potential start-up problems. These capacitors create an effective crystal loading capacitor equal to the series combination of these two capacitors. For the HA7210 in the lowest range, the effective loading capacitance is 7.5pF. Therefore the choice for a crystal, in this range, should be a Parallel Mode crystal that requires a 7.5pF load.

In the higher 3 frequency ranges, the capacitance on OSC IN and OSC OUT will be determined by package and layout parasitics, typically 4 to 5pF. Ideally the choice for crystal should be a Parallel Mode set for 2.5pF load. A crystal manufactured for a different load will be "pulled" from its nominal frequency (see Crystal Pullability).

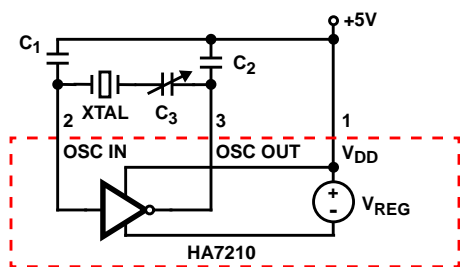

FIGURE 2.

Frequency Fine Tuning

Two Methods will be discussed for fine adjustment of the crystal frequency. The first and preferred method (Figure 2), provides better frequency accuracy and oscillator stability than method two (Figure 3). Method one also eliminates start-up problems sometimes encountered with 32kHz tuning fork crystals.

For best oscillator performance, two conditions must be met: the capacitive load must be matched to both the inverter and crystal to provide ideal conditions for oscillation, and the frequency of the oscillator must be adjustable to the desired

frequency. In Method two these two goals can be at odds with each other; either the oscillator is trimmed to frequency by de-tuning the load circuit, or stability is increased at the expense of absolute frequency accuracy.

Method one allows these two conditions to be met independently. The two fixed capacitors, C₁ and C₂, provide the optimum load to the oscillator and crystal. C₃ adjusts the frequency at which the circuit oscillates without appreciably changing the load (and thus the stability) of the system. Once a value for C₃ has been determined for the particular type of crystal being used, it could be replaced with a fixed capacitor. For the most precise control over oscillator frequency, C₃ should remain adjustable.

This three capacitor tuning method will be more accurate and stable than method two and is recommended for 32kHz tuning fork crystals; without it they may leap into an overtone mode when power is initially applied.

Method two has been used for many years and may be preferred in applications where cost or space is critical. Note that in both cases the crystal loading capacitors are connected between the oscillator and V_{DD}; do not use V_{SS} as an AC ground. The Simplified Block Diagram shows that the oscillating inverter does not directly connect to V_{SS} but is referenced to V_{DD} and V_{RN}. Therefore V_{DD} is the best AC ground available.

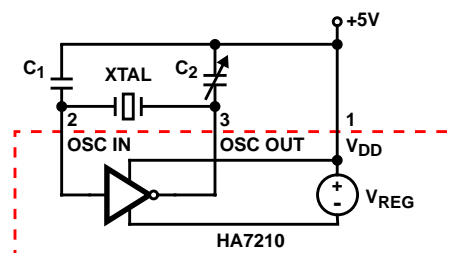

FIGURE 3.

Typical values of the capacitors in Figure 2 are shown below. Some trial and error may be required before the best combination is determined. The values listed are total capacitance including parasitic or other sources. Remember that in the 10kHz to 100kHz frequency range setting the HA7210 switches in two internal 15pF capacitors.

CRYSTAL FREQUENCY	LOAD CAPS C ₁ , C ₂	TRIMMER CAP C ₃
32kHz	33pF	5pF to 50pF
1MHz	33pF	5pF to 50pF
2MHz	25pF	5pF to 50pF
4MHz	22pF	5pF to 100pF

Crystal Pullability

Figure 4 shows the basic equivalent circuit for a crystal and its loading circuit.

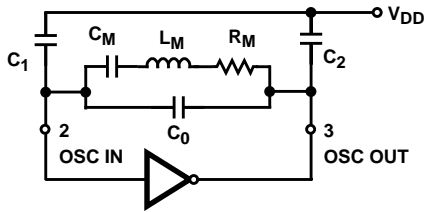

FIGURE 4.

Where:

C_M = Motional Capacitance

L_M = Motional Inductance

R_M = Motional Resistance

C_0 = Shunt Capacitance

$$C_{CL} = \frac{1}{\left(\frac{1}{C_1} + \frac{1}{C_2}\right)} = \text{Equivalent Crystal Load}$$

If loading capacitance is connected to a Series Mode Crystal, the new Parallel Mode frequency of resonance may be calculated with the following equation:

$$f_P = f_S \left[1 + \frac{C_M}{2(C_0 + C_{CL})} \right]$$

Where:

f_P = Parallel Mode Resonant Frequency

f_S = Series Mode Resonant Frequency

In a similar way, the Series Mode resonant frequency may be calculated from a Parallel Mode crystal and then you may calculate how much the frequency will “pull” with a new load.

Layout Considerations

Due to the extremely low current (and therefore high impedance) the circuit board layout of the HA7210 must be given special attention. Stray capacitance should be minimized. Keep the oscillator traces on a single layer of the PCB. Avoid putting a ground plane above or below this layer. The traces between the crystal, the capacitors, and the OSC pins should be as short as possible. Completely surround the oscillator components with a thick trace of V_{DD} to minimize coupling with any digital signals. The final assembly must be free from contaminants such as solder flux, moisture, or any other potential source of leakage. A good solder mask will help keep the traces free of moisture and contamination over time.

Further Reading

Al Little “HA7210 Low Power Oscillator: Micropower Clock Oscillator and Op Amps Provide System Shutdown for Battery Circuits”. Harris Semiconductor Application Note AN9317.

Robert Rood “Improving Start-Up Time at 32kHz for the HA7210 Low Power Crystal Oscillator”. Harris Semiconductor Application Note AN9334.

S. S. Eaton “Timekeeping Advances Through COS/MOS Technology”. Harris Semiconductor Application Note ICAN-6086.

E. A. Vittoz, et. al. “High-Performance Crystal Oscillator Circuits: Theory and Application”. IEEE Journal of Solid-State Circuits, Vol. 23, No. 3, June 1988, pp774-783.

M. A. Unkrich, et. al. “Conditions for Start-Up in Crystal Oscillators”. IEEE Journal of Solid-State Circuits, Vol. 17, No. 1, Feb. 1982, pp87-90.

Marvin E. Frerking “Crystal Oscillator Design and Temperature Compensation”. New York: Van Nostrand-Reinhold, 1978. Pierce Oscillators Discussed pp56-75.

Typical Performance Curves

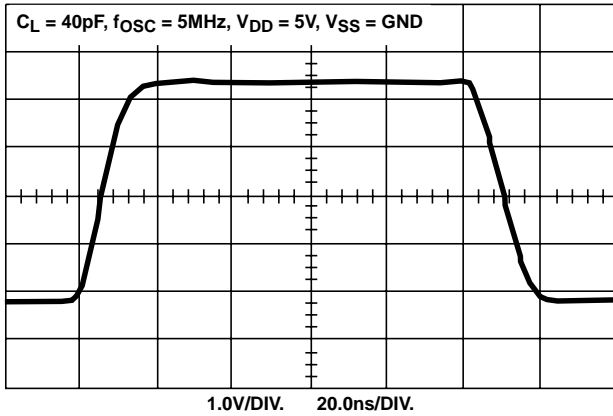

FIGURE 5. OUTPUT WAVEFORM ($C_L = 40\text{pF}$)

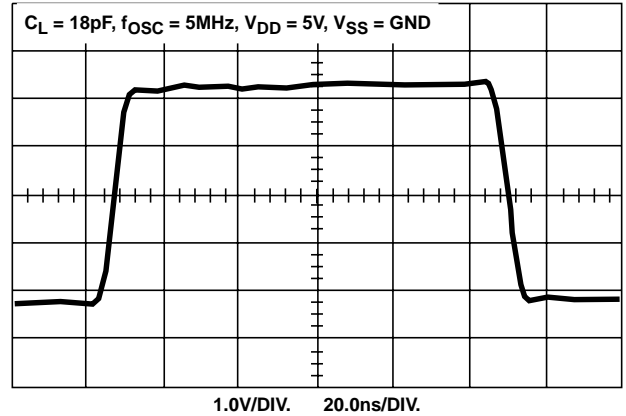

FIGURE 6. OUTPUT WAVEFORM ($C_L = 18\text{pF}$)

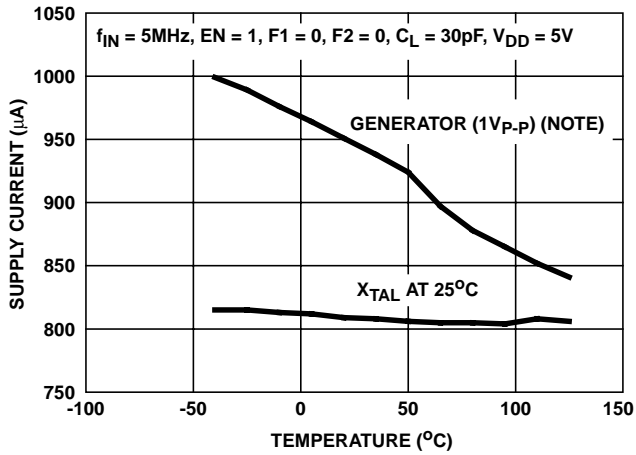

FIGURE 7. SUPPLY CURRENT vs TEMPERATURE

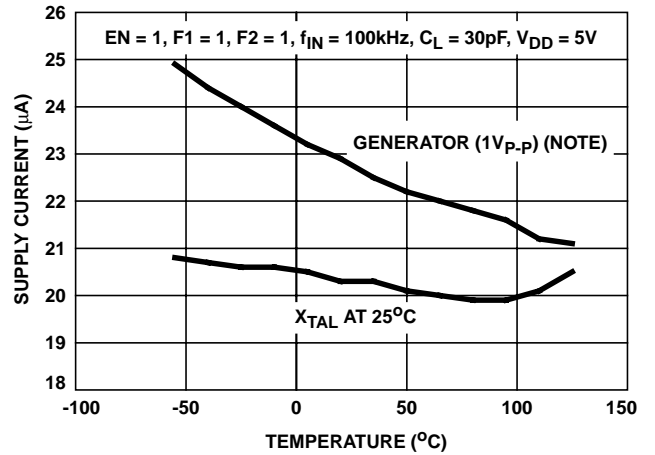

FIGURE 8. SUPPLY CURRENT vs TEMPERATURE

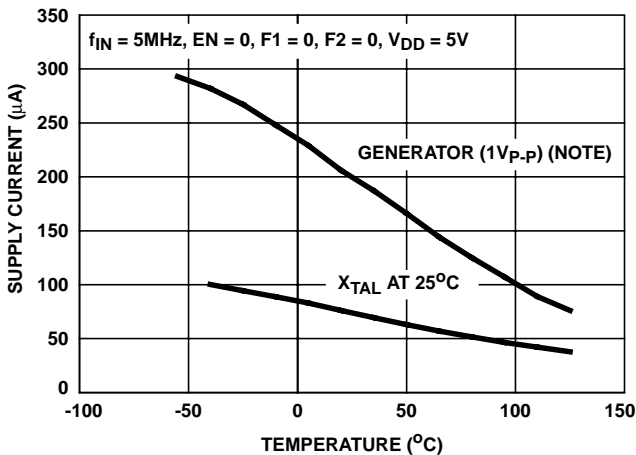

FIGURE 9. DISABLE SUPPLY CURRENT vs TEMPERATURE

NOTE: Refer to Test Circuit (Figure 1).

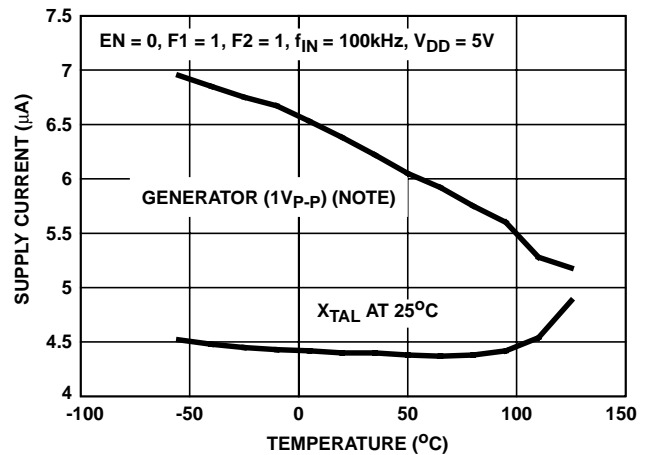

FIGURE 10. DISABLE SUPPLY CURRENT vs TEMPERATURE

Typical Performance Curves (Continued)

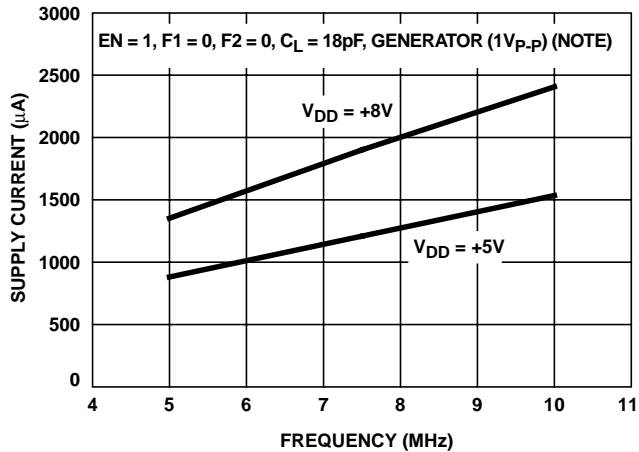

FIGURE 11. SUPPLY CURRENT vs FREQUENCY

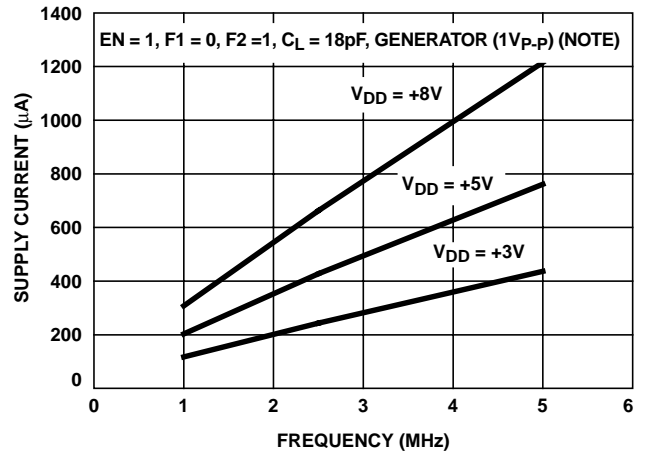

FIGURE 12. SUPPLY CURRENT vs FREQUENCY

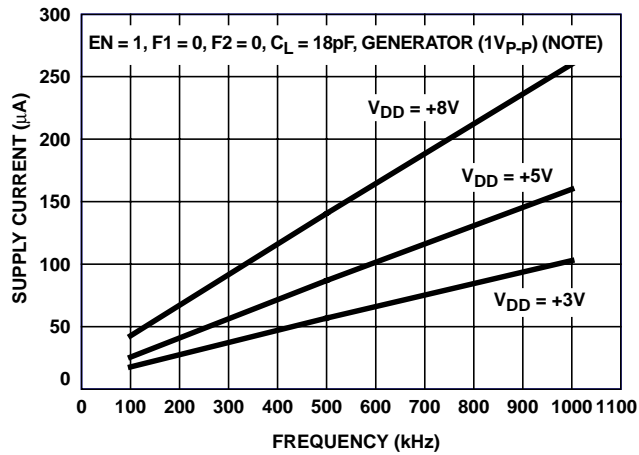

FIGURE 13. SUPPLY CURRENT vs FREQUENCY

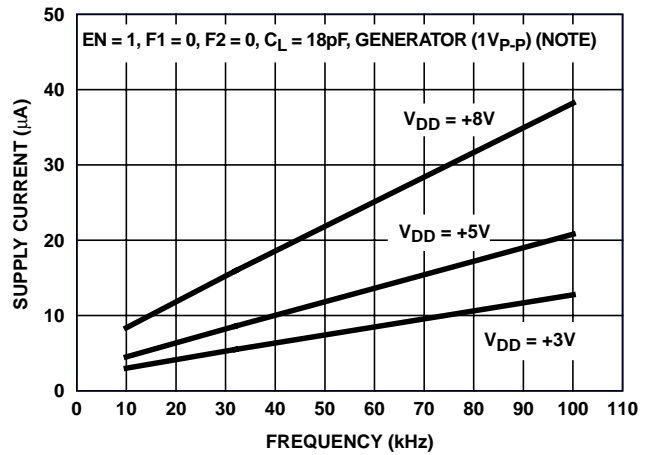

FIGURE 14. SUPPLY CURRENT vs FREQUENCY

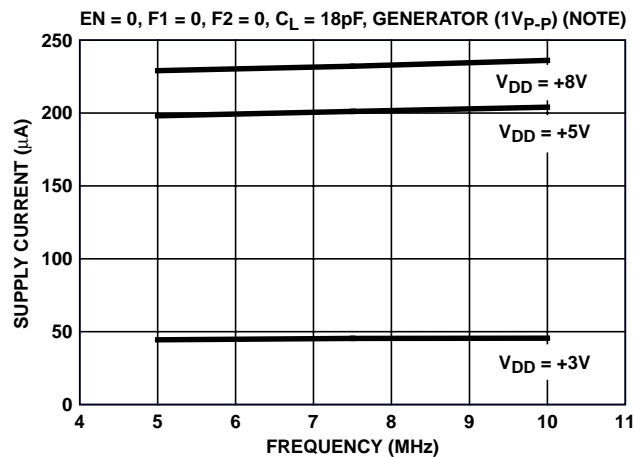

FIGURE 15. DISABLED SUPPLY CURRENT vs FREQUENCY

NOTE: Refer to Test Circuit (Figure 1).

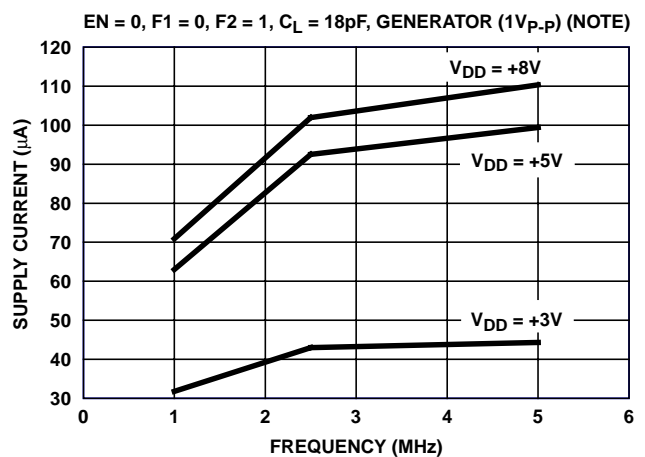

FIGURE 16. DISABLE SUPPLY CURRENT vs FREQUENCY

Typical Performance Curves (Continued)

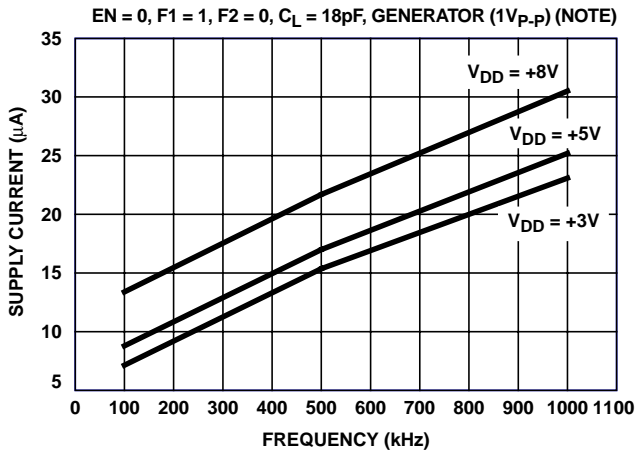

FIGURE 17. DISABLE SUPPLY CURRENT vs FREQUENCY

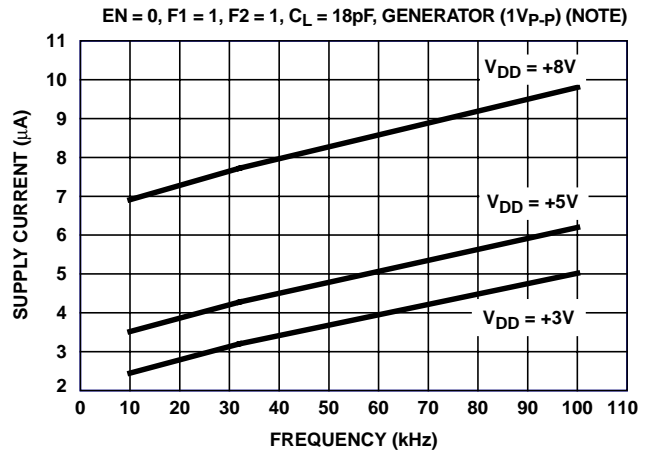

FIGURE 18. DISABLE SUPPLY CURRENT vs FREQUENCY

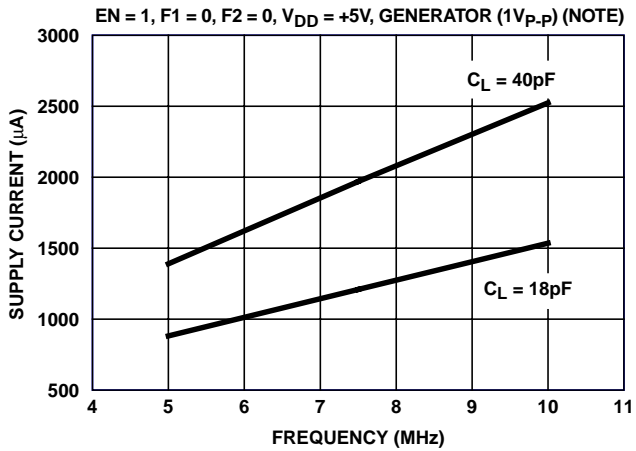

FIGURE 19. SUPPLY CURRENT vs FREQUENCY

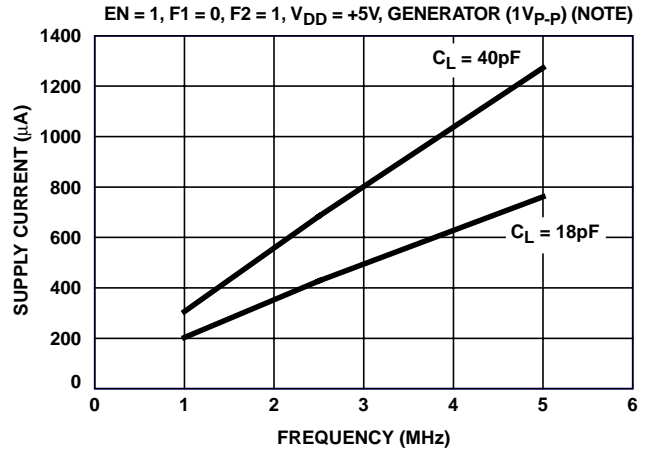

FIGURE 20. SUPPLY CURRENT vs FREQUENCY

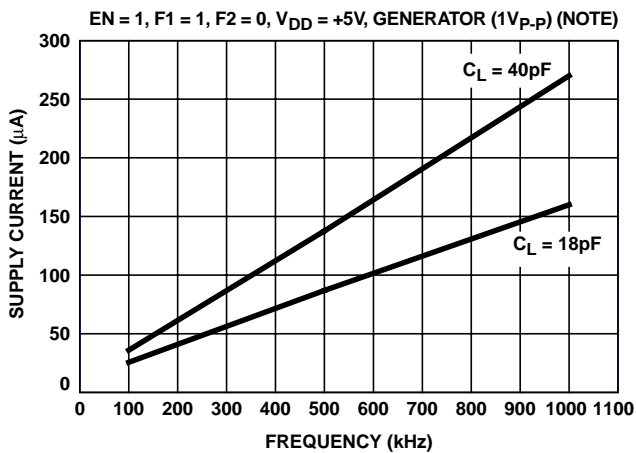

FIGURE 21. SUPPLY CURRENT vs FREQUENCY

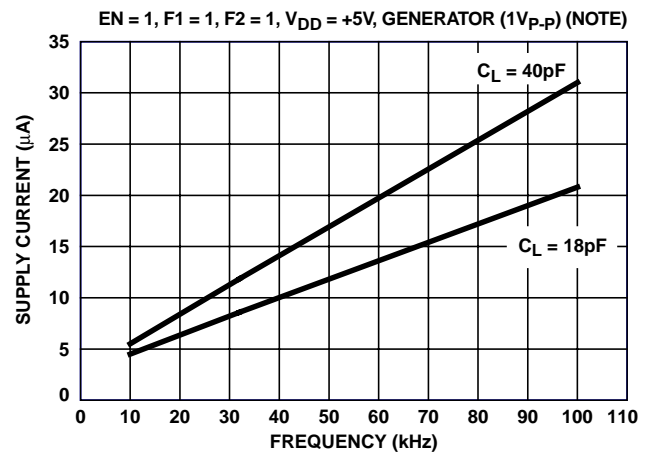

FIGURE 22. SUPPLY CURRENT vs FREQUENCY

NOTE: Refer to Test Circuit (Figure 1).

Typical Performance Curves (Continued)

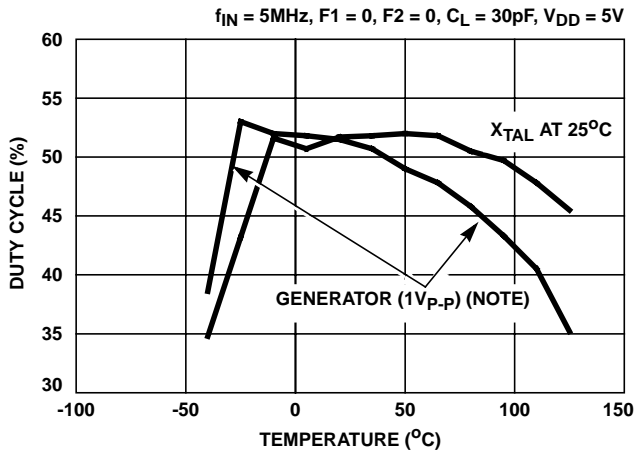

FIGURE 23. DUTY CYCLE vs TEMPERATURE

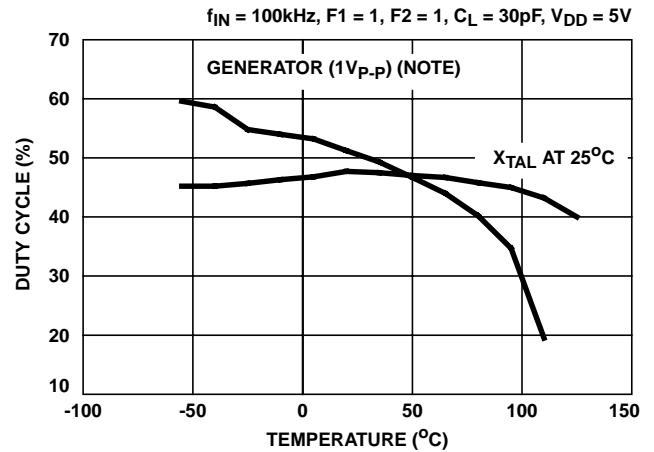

FIGURE 24. DUTY CYCLE vs TEMPERATURE

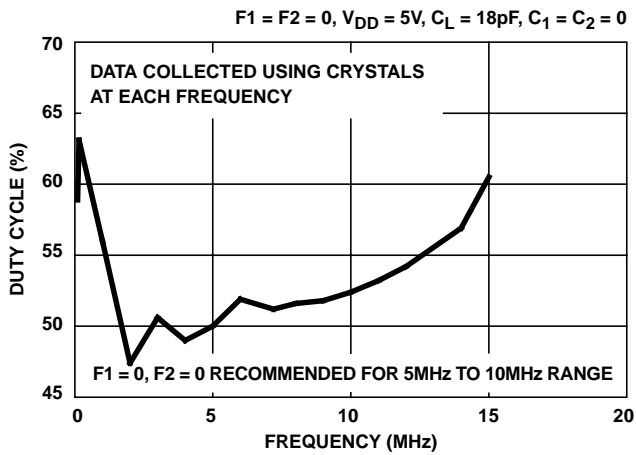

FIGURE 25. DUTY CYCLE vs FREQUENCY

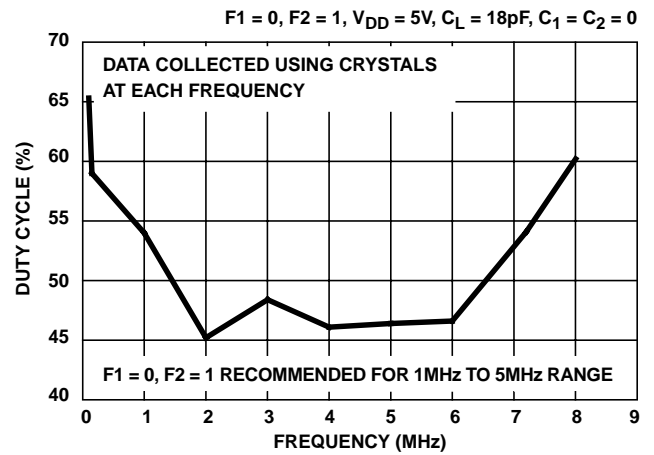

FIGURE 26. DUTY CYCLE vs FREQUENCY

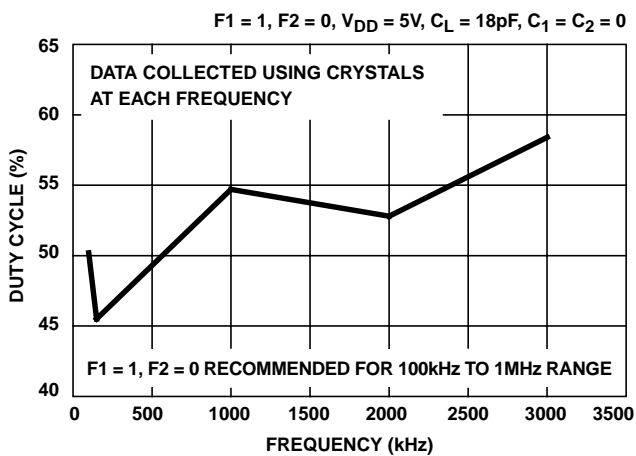

FIGURE 27. DUTY CYCLE vs FREQUENCY

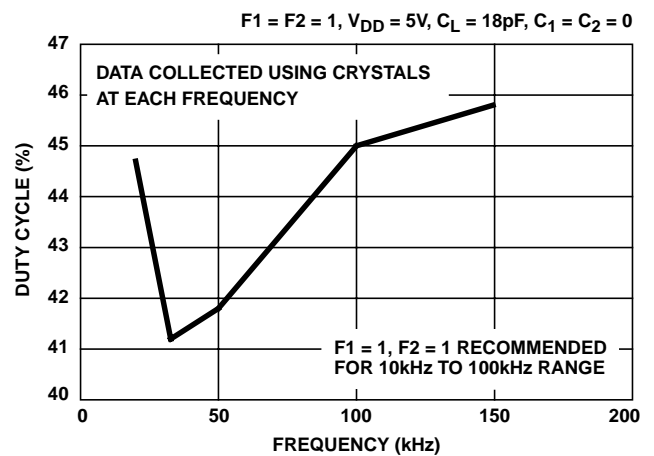

FIGURE 28. DUTY CYCLE vs FREQUENCY

NOTE: Refer to Test Circuit (Figure 1).

Typical Performance Curves (Continued)

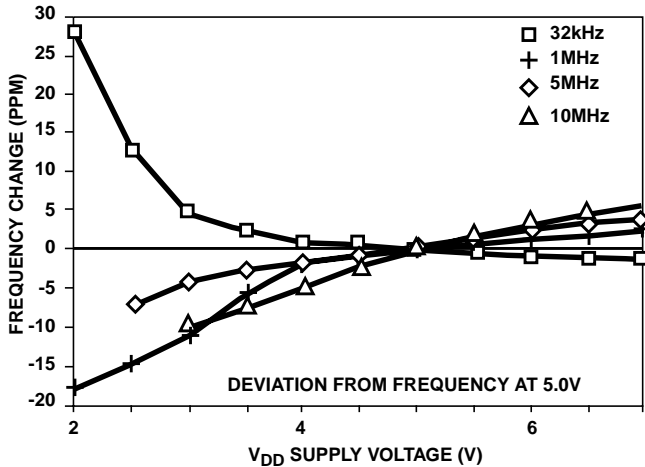

FIGURE 29. FREQUENCY CHANGE vs V_{DD}

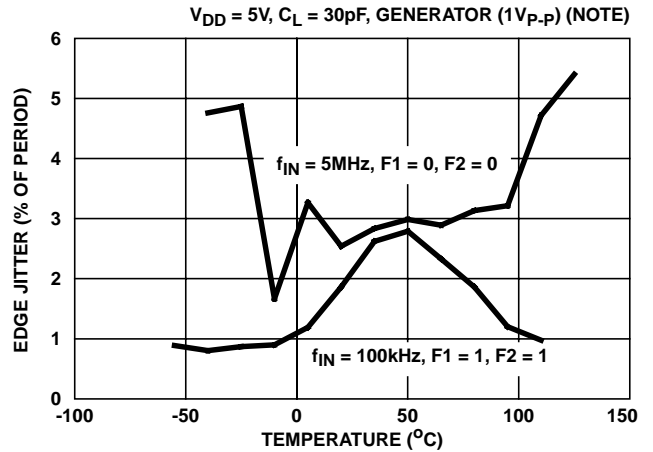

FIGURE 30. EDGE JITTER vs TEMPERATURE

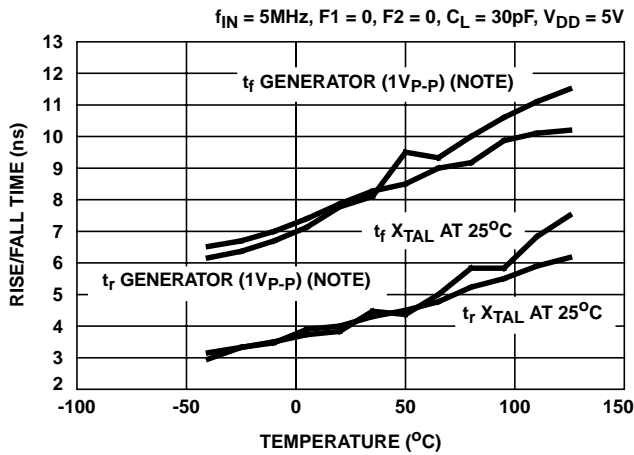

FIGURE 31. RISE/FALL TIME vs TEMPERATURE

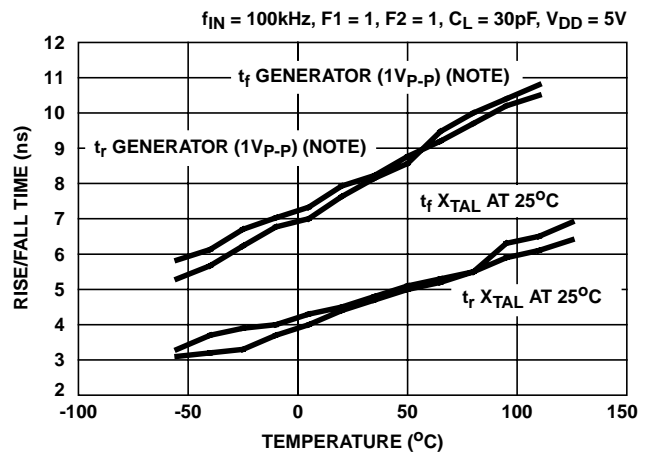

FIGURE 32. RISE/FALL TIME vs TEMPERATURE

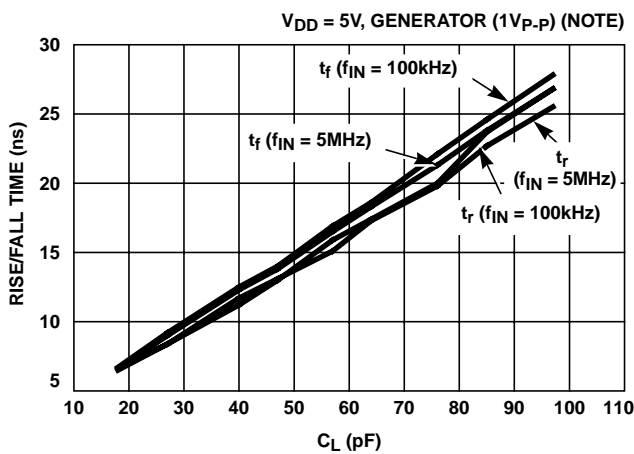

FIGURE 33. RISE/FALL TIME vs C_L

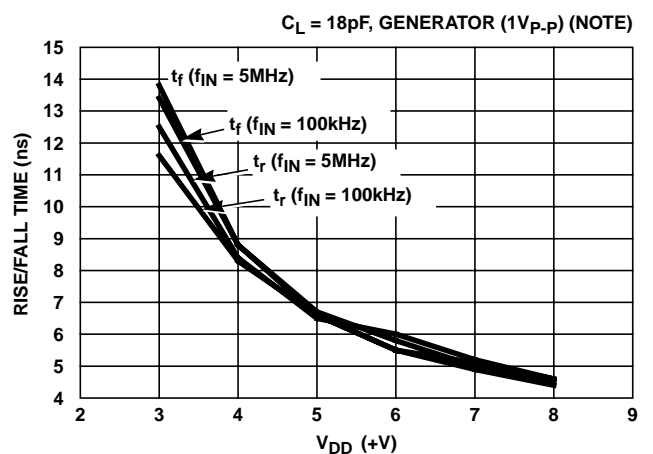

FIGURE 34. RISE/FALL TIME vs V_{DD}

NOTE: Refer to Test Circuit (Figure 1).

Typical Performance Curves (Continued)

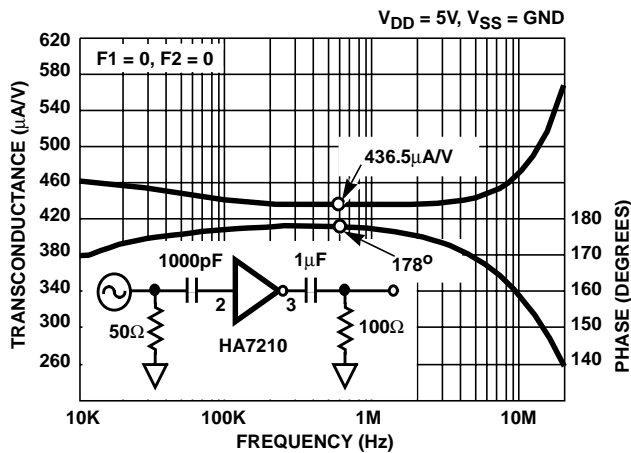

FIGURE 35. TRANSCONDUCTANCE vs FREQUENCY

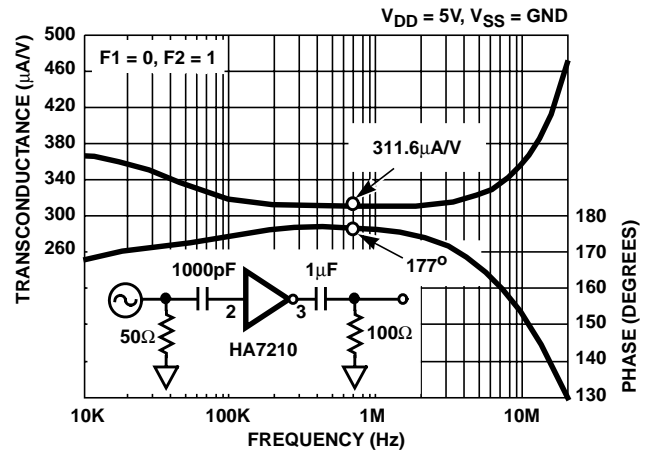

FIGURE 36. TRANSCONDUCTANCE vs FREQUENCY

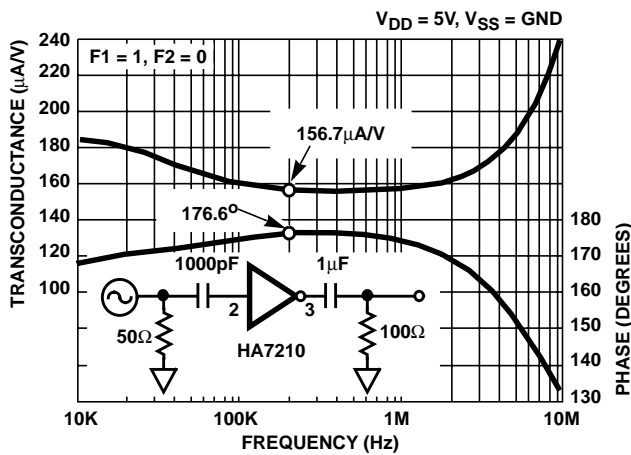

FIGURE 37. TRANSCONDUCTANCE vs FREQUENCY

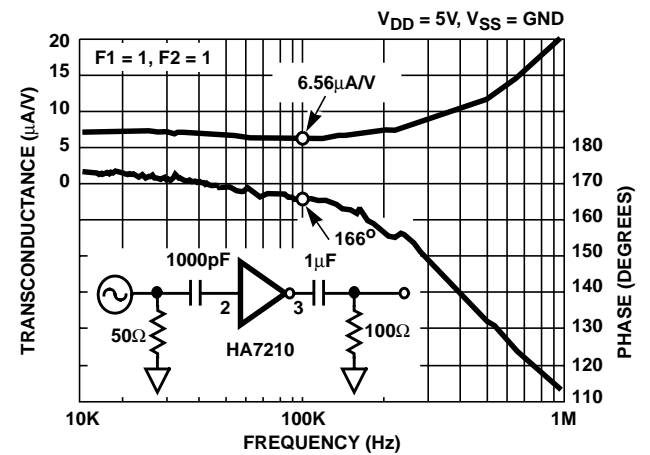
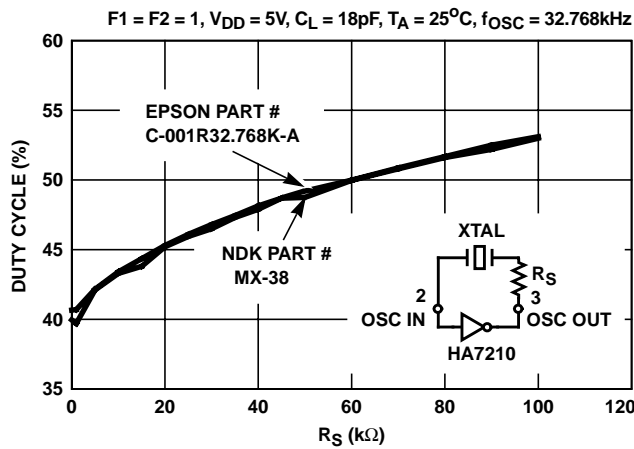

FIGURE 38. TRANSCONDUCTANCE vs FREQUENCY



NOTE: Figure 39 (Duty Cycle vs R_S at 32kHz) should only be used for 32kHz crystals. R_S may be used at other frequencies to adjust Duty Cycle but experimentation will be required to find an appropriate value. The R_S value will be proportional to the effective series resistance of the crystal being used.

FIGURE 39. DUTY CYCLE vs R_S at 32kHz

NOTE: Refer to Test Circuit (Figure 1).

HA7210

Die Characteristics

DIE DIMENSIONS:

68 mils x 64 mils x 14 mils

METALLIZATION:

Type: SiAl

Thickness: $10\text{k}\text{\AA} \pm 1\text{k}\text{\AA}$

SUBSTRATE POTENTIAL:

V_{SS}

PASSIVATION:

Type: Nitride (Si_3N_4) Over Silox (SiO_2 , 3% Phos)

Silox Thickness: $7\text{k}\text{\AA} \pm 1\text{k}\text{\AA}$

Nitride Thickness: $8\text{k}\text{\AA} \pm 1\text{k}\text{\AA}$

Metallization Mask Layout

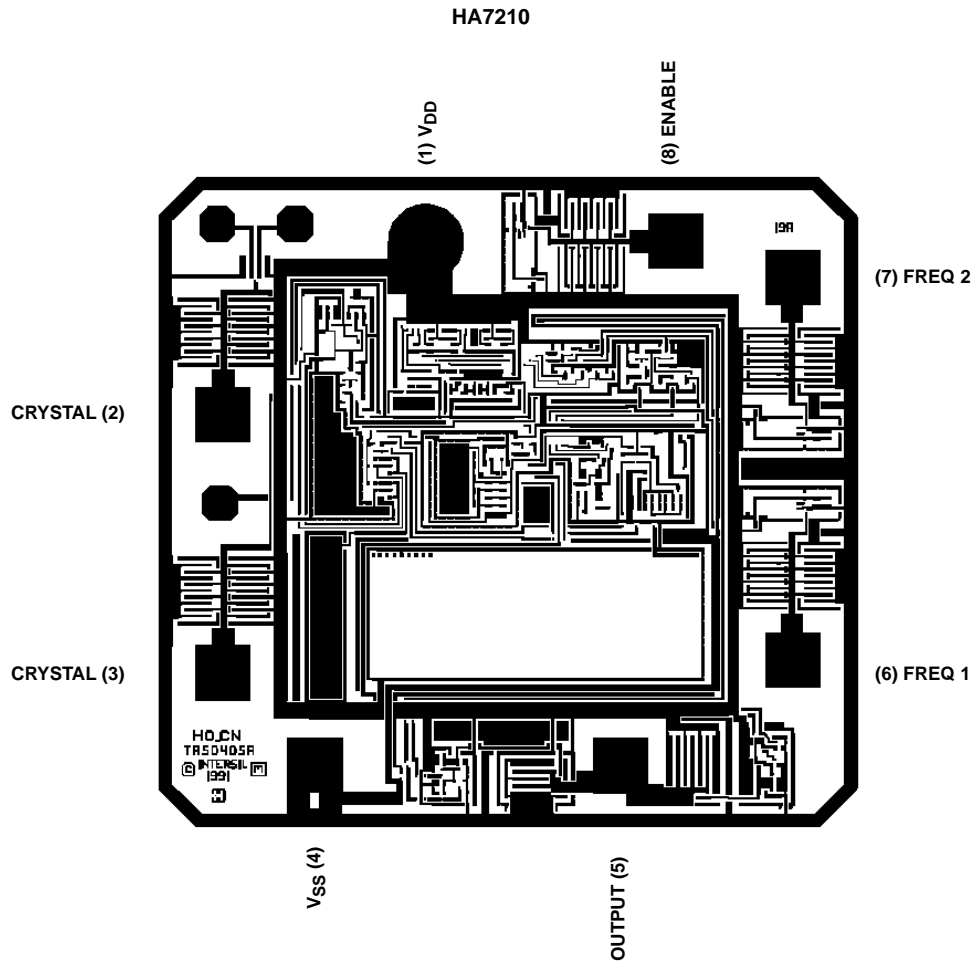

Dual-In-Line Plastic Packages (PDIP)

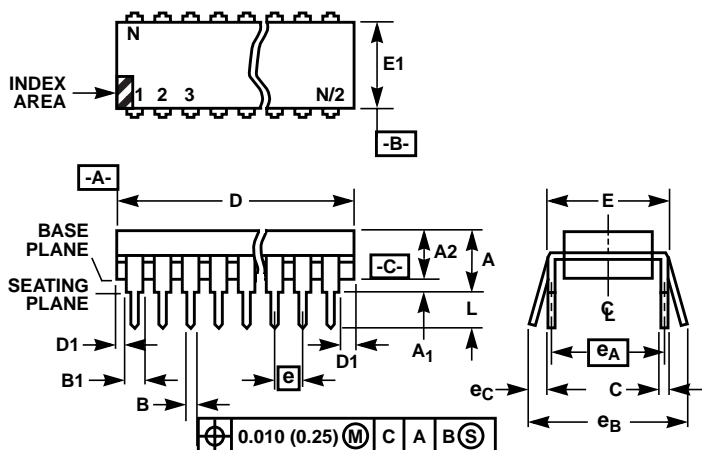

NOTES:

1. Controlling Dimensions: INCH. In case of conflict between English and Metric dimensions, the inch dimensions control.
2. Dimensioning and tolerancing per ANSI Y14.5M-1982.
3. Symbols are defined in the "MO Series Symbol List" in Section 2.2 of Publication No. 95.
4. Dimensions A, A1 and L are measured with the package seated in JEDEC seating plane gauge GS-3.
5. D, D1, and E1 dimensions do not include mold flash or protrusions. Mold flash or protrusions shall not exceed 0.010 inch (0.25mm).
6. E and e_A are measured with the leads constrained to be perpendicular to datum -C-.
7. e_B and e_C are measured at the lead tips with the leads unconstrained. e_C must be zero or greater.
8. B1 maximum dimensions do not include dambar protrusions. Dambar protrusions shall not exceed 0.010 inch (0.25mm).
9. N is the maximum number of terminal positions.
10. Corner leads (1, N, N/2 and N/2 + 1) for E8.3, E16.3, E18.3, E28.3, E42.6 will have a B1 dimension of 0.030 - 0.045 inch (0.76 - 1.14mm).

E8.3 (JEDEC MS-001-BA ISSUE D)
8 LEAD DUAL-IN-LINE PLASTIC PACKAGE

SYMBOL	INCHES		MILLIMETERS		NOTES
	MIN	MAX	MIN	MAX	
A	-	0.210	-	5.33	4
A1	0.015	-	0.39	-	4
A2	0.115	0.195	2.93	4.95	-
B	0.014	0.022	0.356	0.558	-
B1	0.045	0.070	1.15	1.77	8, 10
C	0.008	0.014	0.204	0.355	-
D	0.355	0.400	9.01	10.16	5
D1	0.005	-	0.13	-	5
E	0.300	0.325	7.62	8.25	6
E1	0.240	0.280	6.10	7.11	5
e	0.100 BSC		2.54 BSC		-
e _A	0.300 BSC		7.62 BSC		6
e _B	-	0.430	-	10.92	7
L	0.115	0.150	2.93	3.81	4
N	8		8		9

Rev. 0 12/93

Small Outline Plastic Packages (SOIC)

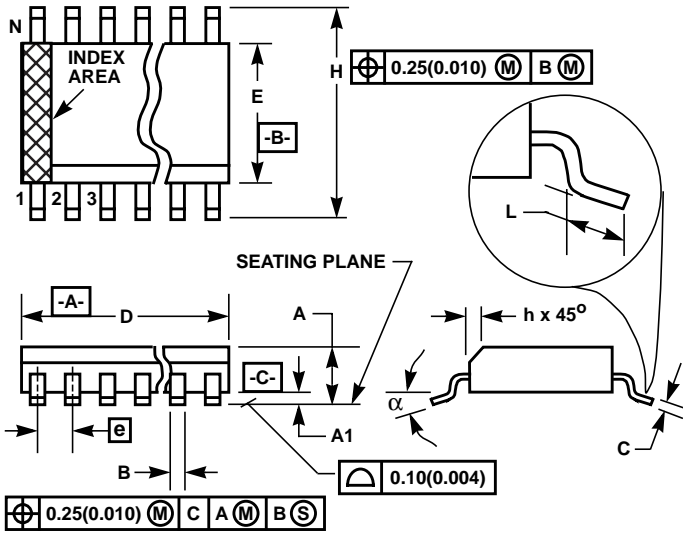

M8.15 (JEDEC MS-012-AA ISSUE C)
8 LEAD NARROW BODY SMALL OUTLINE PLASTIC PACKAGE

SYMBOL	INCHES		MILLIMETERS		NOTES
	MIN	MAX	MIN	MAX	
A	0.0532	0.0688	1.35	1.75	-
A1	0.0040	0.0098	0.10	0.25	-
B	0.013	0.020	0.33	0.51	9
C	0.0075	0.0098	0.19	0.25	-
D	0.1890	0.1968	4.80	5.00	3
E	0.1497	0.1574	3.80	4.00	4
e	0.050 BSC		1.27 BSC		-
H	0.2284	0.2440	5.80	6.20	-
h	0.0099	0.0196	0.25	0.50	5
L	0.016	0.050	0.40	1.27	6
N	8		8		7
α	0°	8°	0°	8°	-

NOTES:

1. Symbols are defined in the "MO Series Symbol List" in Section 2.2 of Publication Number 95.
2. Dimensioning and tolerancing per ANSI Y14.5M-1982.
3. Dimension "D" does not include mold flash, protrusions or gate burrs. Mold flash, protrusion and gate burrs shall not exceed 0.15mm (0.006 inch) per side.
4. Dimension "E" does not include interlead flash or protrusions. Interlead flash and protrusions shall not exceed 0.25mm (0.010 inch) per side.
5. The chamfer on the body is optional. If it is not present, a visual index feature must be located within the crosshatched area.
6. "L" is the length of terminal for soldering to a substrate.
7. "N" is the number of terminal positions.
8. Terminal numbers are shown for reference only.
9. The lead width "B", as measured 0.36mm (0.014 inch) or greater above the seating plane, shall not exceed a maximum value of 0.61mm (0.024 inch).
10. Controlling dimension: MILLIMETER. Converted inch dimensions are not necessarily exact.

Rev. 0 12/93

All Intersil semiconductor products are manufactured, assembled and tested under **ISO9000** quality systems certification.

Intersil semiconductor products are sold by description only. Intersil Corporation reserves the right to make changes in circuit design and/or specifications at any time without notice. Accordingly, the reader is cautioned to verify that data sheets are current before placing orders. Information furnished by Intersil is believed to be accurate and reliable. However, no responsibility is assumed by Intersil or its subsidiaries for its use; nor for any infringements of patents or other rights of third parties which may result from its use. No license is granted by implication or otherwise under any patent or patent rights of Intersil or its subsidiaries.

For information regarding Intersil Corporation and its products, see web site <http://www.intersil.com>

Sales Office Headquarters

NORTH AMERICA

Intersil Corporation
 P. O. Box 883, Mail Stop 53-204
 Melbourne, FL 32902
 TEL: (407) 724-7000
 FAX: (407) 724-7240

EUROPE

Intersil SA
 Mercure Center
 100, Rue de la Fusée
 1130 Brussels, Belgium
 TEL: (32) 2.724.2111
 FAX: (32) 2.724.22.05

ASIA

Intersil (Taiwan) Ltd.
 7F-6, No. 101 Fu Hsing North Road
 Taipei, Taiwan
 Republic of China
 TEL: (886) 2 2716 9310
 FAX: (886) 2 2715 3029