

High Current, High Frequency, Power Inductors

FLAT-PAC™ FP1107 Series

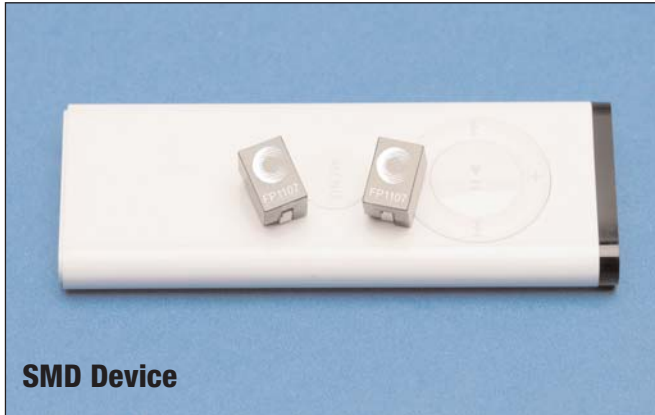

SMD Device

Description:

- Halogen free
- 125°C maximum total temperature operation
- 7.2 x 11.0 x 7.5mm surface mount package
- Ferrite core material
- High current carrying capacity, low core losses
- Controlled DCR tolerance for sensing circuits
- Inductance range from 70nH to 510nH

- Current range from 18 amps to 140 amps
- Frequency range up to 2MHz
- RoHS compliant

Applications:

- Multi-phase regulators
- Voltage Regulator Module (VRM)
- Desktop and server VRMs and EVRDs
- Data networking and storage systems
- Notebook regulators
- Graphics cards and battery power systems
- Point-of-load modules
- DCR sensing

Environmental Data:

- Storage temperature range: -40°C to +125°C
- Operating temperature range: -40°C to +125°C (ambient plus self-temperature rise)
- Solder reflow temperature: J-STD-020D compliant

Packaging:

- Supplied in tape and reel packaging, 640 parts per reel, 13" diameter reel

Product Specifications

Part Number ⁷	OCL ¹ ± 10% (nH)	FLL ² Min. (nH)	I _{rms} ³ (Amps)	I _{sat} ^{1,4} @ 25°C (Amps)	I _{sat} ^{2,5} @ 125°C (Amps)	DCR (mΩ) @ 20°C	K-factor ⁶
R1 Version							
FP1107R1-R07-R	70	50	55	140	123	0.29 ± 8%	361.1
FP1107R1-R12-R	120	86		90	72		361.1
FP1107R1-R15-R	150	108		70	56		361.1
FP1107R1-R23-R	230	166		45	36		361.1
FP1107R1-R30-R	300	217		35	28		361.1
FP1107R1-R40-R	400	288		25	20		361.1
FP1107R1-R51-R	510	364		18	14.5		361.1
R2 Version							
FP1107R2-R07-R	70	50	42	140	123	0.47 ± 6.4%	363.3
FP1107R2-R12-R	120	86		90	72		363.3
FP1107R2-R15-R	150	108		70	56		363.3
FP1107R2-R23-R	230	166		45	36		363.3
FP1107R2-R30-R	300	217		35	28		363.3
FP1107R2-R40-R	400	288		25	20		363.3
FP1107R2-R51-R	510	364		18	14.5		363.3

1 Open Circuit Inductance (OCL) Test Parameters: 100kHz, 0.1V_{rms}, 0.0Adc

2 Full Load Inductance (FLL) Test Parameters: 100kHz, 0.1V_{rms}, I_{sat}¹

3 I_{rms}: DC current for an approximate temperature rise of 40°C without core loss. Derating is necessary for AC currents. PCB pad layout, trace thickness and width, air-flow and proximity of other heat generating components will affect the temperature rise. It is recommended the part temperature not exceed 125°C under worst case operating conditions verified in the end application.

4 I_{sat}¹: Peak current for approximately 20% rolloff at +25°C.

5 I_{sat}²: Peak current for approximately 20% rolloff at +125°C.

6 K-factor: Used to determine B_{p-p} for core loss (see graph). B_{p-p} = K · L · ΔI · 10⁻³, B_{p-p}: (Gauss), K: (K-factor from table), L: (inductance in nH), ΔI (peak-to-peak ripple current in amps).

7 Part Number Definition: FP1107Rx-Rxx-R

• FP1107 = Product code and size

• Rxx= Inductance value in μH, R = decimal point

• Rx is the DCR indicator

• "-R" suffix = RoHS compliant

Dimensions - mm

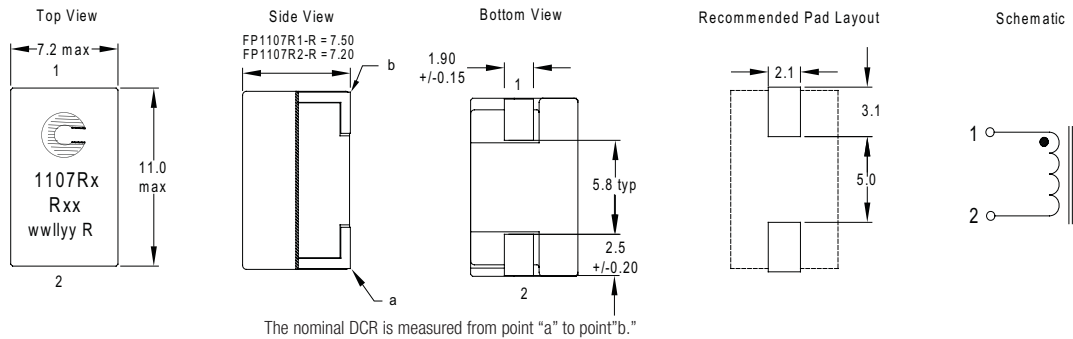

Part Marking: Coiltronics Logo 1107Rx (Rx = DCR Indicator) Rxx = Inductance value in μH . (R = Decimal point) wwlyy = Date code R = Revision level

Packaging Information - mm

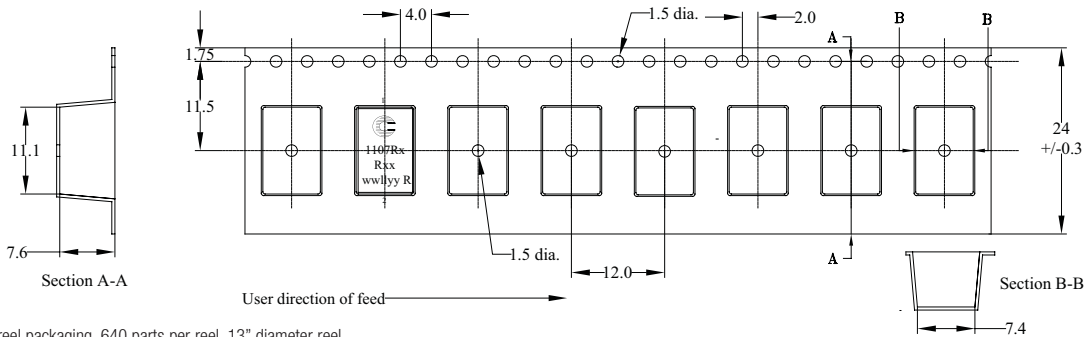

Supplied in tape-and-reel packaging, 640 parts per reel, 13" diameter reel.

Temperature Rise vs. Total Loss

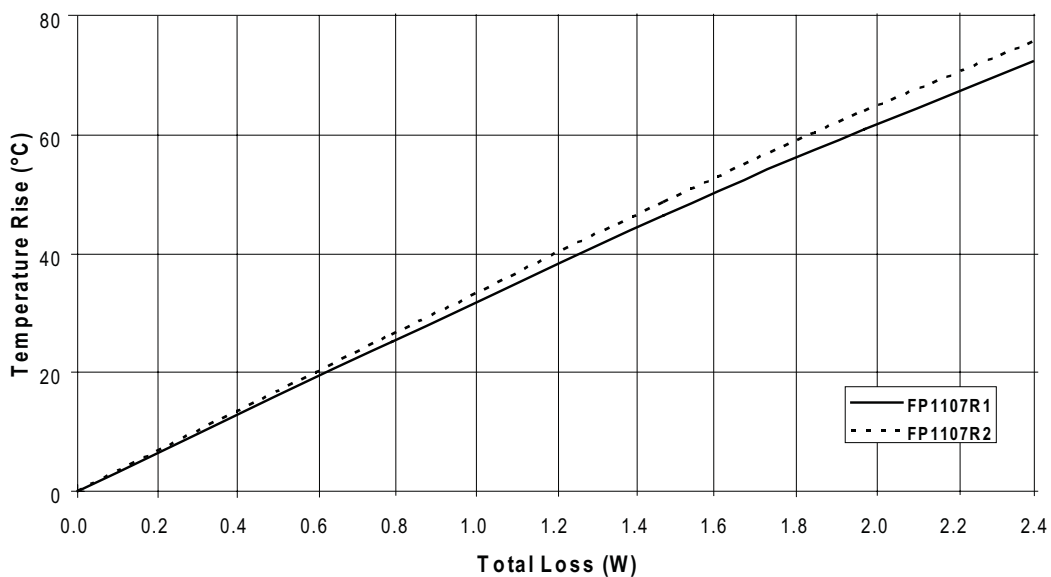

Core Loss

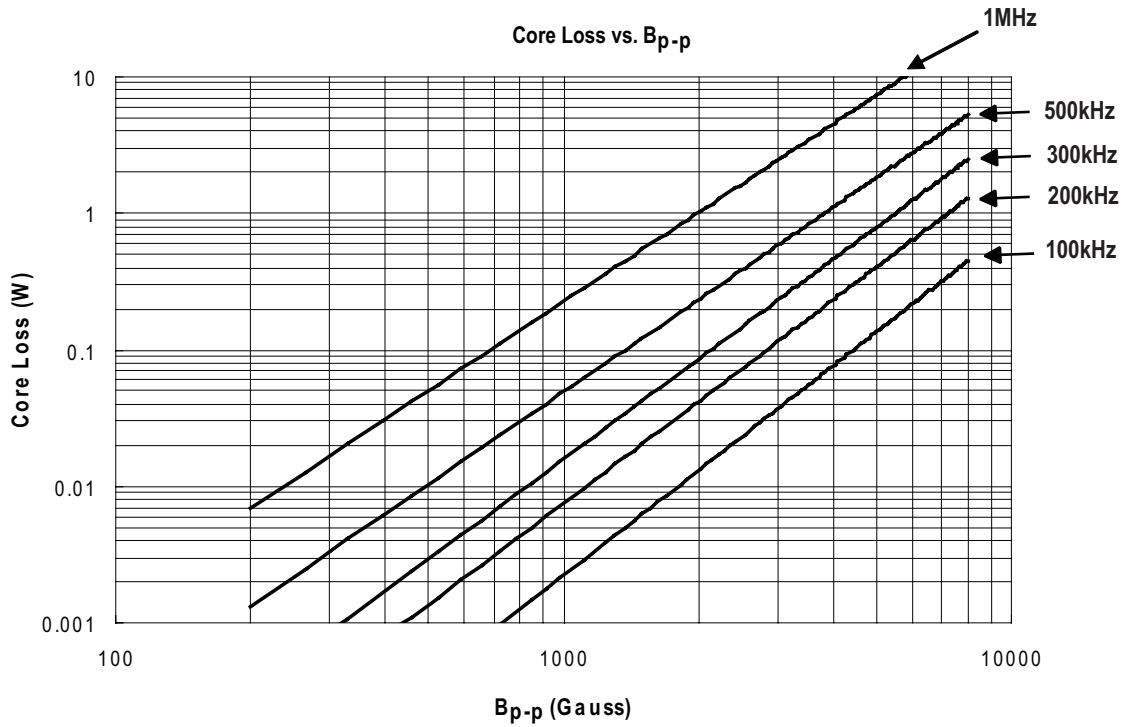

Inductance Characteristics

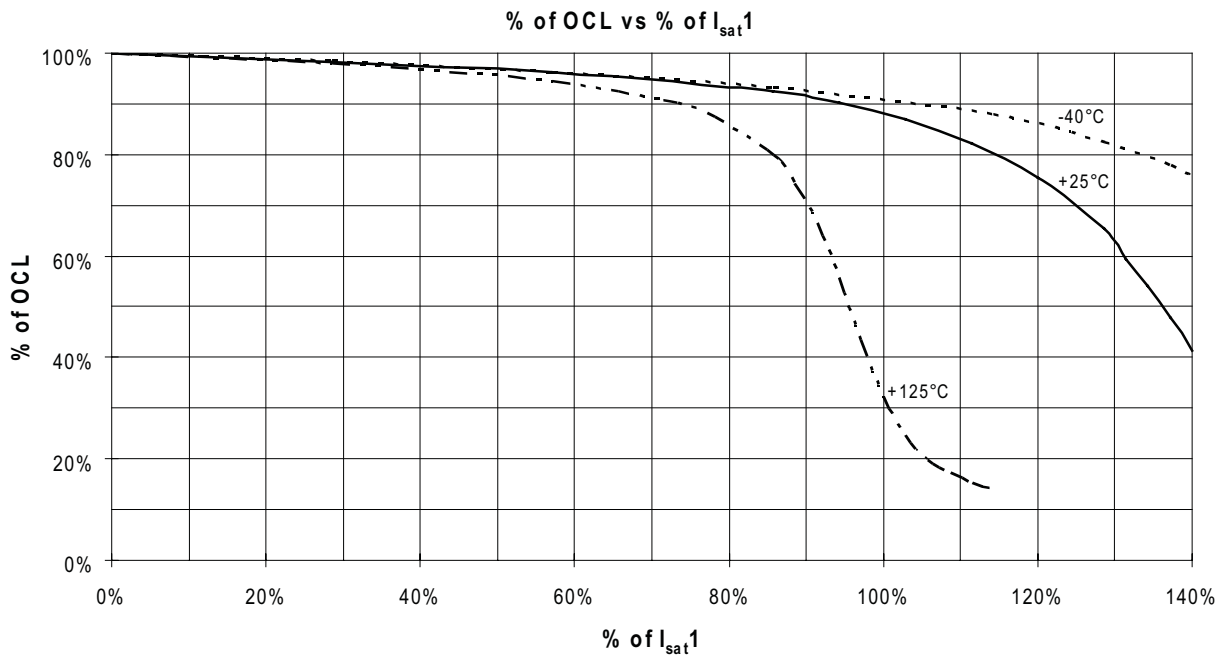

Solder Reflow Profile

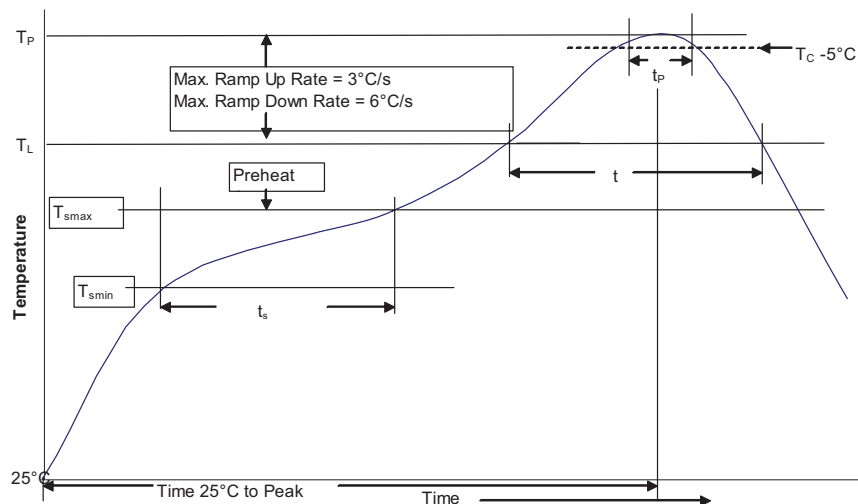

Table 1 - Standard SnPb Solder (T_c)

Package Thickness	Volume mm^3 <350	Volume mm^3 ≥ 350
<2.5mm	235°C	220°C
$\geq 2.5\text{mm}$	220°C	220°C

Table 2 - Lead (Pb) Free Solder (T_c)

Package Thickness	Volume mm^3 <350	Volume mm^3 350 - 2000	Volume mm^3 >2000
<1.6mm	260°C	260°C	260°C
1.6 - 2.5mm	260°C	250°C	245°C
>2.5mm	250°C	245°C	245°C

Reference JDEC J-STD-020D

Profile Feature	Standard SnPb Solder	Lead (Pb) Free Solder
Preheat and Soak		
• Temperature min. (T_{smin})	100°C	150°C
• Temperature max. (T_{smax})	150°C	200°C
• Time (T_{smin} to T_{smax}) (t_s)	60-120 Seconds	60-120 Seconds
Average ramp up rate T_{smax} to T_P	3°C/ Second Max.	3°C/ Second Max.
Liquidous temperature (T_L)	183°C	217°C
Time at liquidous (t_L)	60-150 Seconds	60-150 Seconds
Peak package body temperature (T_P)*	Table 1	Table 2
Time (t_p)** within 5 °C of the specified classification temperature (T_c)	20 Seconds**	30 Seconds**
Average ramp-down rate (T_P to T_{smax})	6°C/ Second Max.	6°C/ Second Max.
Time 25°C to Peak Temperature	6 Minutes Max.	8 Minutes Max.

* Tolerance for peak profile temperature (T_P) is defined as a supplier minimum and a user maximum.

** Tolerance for time at peak profile temperature (t_p) is defined as a supplier minimum and a user maximum.

North America

Cooper Electronic Technologies
1225 Broken Sound Parkway NW
Suite F
Boca Raton, FL 33487-3533
Tel: 1-561-998-4100
Fax: 1-561-241-6640
Toll Free: 1-888-414-2645

Cooper Bussmann
P.O. Box 14460
St. Louis, MO 63178-4460
Tel: 1-636-394-2877
Fax: 1-636-527-1607

Europe

Cooper Electronic Technologies
Cooper (UK) Limited
Burton-on-the-Wolds
Leicestershire • LE12 5TH UK
Tel: +44 (0) 1509 882 737
Fax: +44 (0) 1509 882 786

Cooper Electronic Technologies
Avda. Santa Eulalia, 290
08223
Terrassa, (Barcelona), Spain
Tel: +34 937 362 812
+34 937 362 813
Fax: +34 937 362 719

Asia Pacific

Cooper Electronic Technologies
1 Jalan Kilang Timor
#06-01 Pacific Tech Centre
Singapore 159303
Tel: +65 278 6151
Fax: +65 270 4160

The only controlled copy of this Data Sheet is the electronic read-only version located on the Cooper Bussmann Network Drive. All other copies of this document are by definition uncontrolled. This bulletin is intended to clearly present comprehensive product data and provide technical information that will help the end user with design applications. Cooper Bussmann reserves the right, without notice, to change design or construction of any products and to discontinue or limit distribution of any products. Cooper Bussmann also reserves the right to change or update, without notice, any technical information contained in this bulletin. Once a product has been selected, it should be tested by the user in all possible applications.

Life Support Policy: Cooper Bussmann does not authorize the use of any of its products for use in life support devices or systems without the express written approval of an officer of the Company. Life support systems are devices which support or sustain life, and whose failure to perform, when properly used in accordance with instructions for use provided in the labeling, can be reasonably expected to result in significant injury to the user.