

Fast Switching EmCon Diode

Feature

- 600 V EmCon technology
- Fast recovery
- Soft switching
- Low reverse recovery charge
- Low forward voltage
- 175°C operating temperature
- Easy paralleling
- Qualified according to JEDEC⁰⁾ for target applications

Product Summary

V_{RRM}	600	V
I_F	15	A
V_F	1.5	V
T_{jmax}	175	°C

PG -TO263-3-2

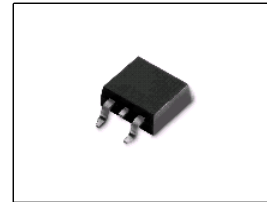

Type	Package	Ordering Code	Marking	Pin 1	PIN 2	PIN 3
IDB15E60	PG-TO263-3-2	-	D15E60	NC	C	A

Maximum Ratings, at $T_j = 25\text{ °C}$, unless otherwise specified

Parameter	Symbol	Value	Unit
Repetitive peak reverse voltage	V_{RRM}	600	V
Continuous forward current	I_F		A
$T_C=25\text{ °C}$		29.2	
$T_C=90\text{ °C}$		19.6	
Surge non repetitive forward current	I_{FSM}	60	
$T_C=25\text{ °C}$, $t_p=10\text{ ms}$, sine halfwave			
Maximum repetitive forward current	I_{FRM}	45	
$T_C=25\text{ °C}$, t_p limited by T_{jmax} , $D=0.5$			
Power dissipation	P_{tot}		W
$T_C=25\text{ °C}$		83.3	
$T_C=90\text{ °C}$		47.2	
Operating and storage temperature	T_j, T_{stg}	-55...+175	°C
Soldering temperature reflow soldering, MSL1	T_S	245	°C

Thermal Characteristics

Parameter	Symbol	Values			Unit
		min.	typ.	max.	
Characteristics					
Thermal resistance, junction - case	R_{thJC}	-	-	1.8	K/W
Thermal resistance, junction - ambient, leaded	R_{thJA}	-	-	62	
SMD version, device on PCB:	R_{thJA}				
@ min. footprint		-	-	62	
@ 6 cm ² cooling area ¹⁾		-	35	-	

Electrical Characteristics, at $T_j = 25\text{ °C}$, unless otherwise specified

Parameter	Symbol	Values			Unit
		min.	typ.	max.	
Static Characteristics					
Reverse leakage current	I_R				μA
$V_R=600\text{V}, T_j=25\text{°C}$		-	-	50	
$V_R=600\text{V}, T_j=150\text{°C}$		-	-	1250	
Forward voltage drop	V_F				V
$I_F=15\text{A}, T_j=25\text{°C}$		-	1.5	2	
$I_F=15\text{A}, T_j=150\text{°C}$		-	1.5	-	

⁰J-STD20 and JESD22

¹Device on 40mm*40mm*1.5mm epoxy PCB FR4 with 6cm² (one layer, 70 μm thick) copper area for drain connection. PCB is vertical without blown air.

Electrical Characteristics, at $T_j = 25\text{ }^\circ\text{C}$, unless otherwise specified

Parameter	Symbol	Values			Unit
		min.	typ.	max.	
Dynamic Characteristics					
Reverse recovery time	t_{rr}				ns
$V_R=400\text{V}$, $I_F=15\text{A}$, $di_F/dt=1000\text{A}/\mu\text{s}$, $T_j=25^\circ\text{C}$		-	87	-	
$V_R=400\text{V}$, $I_F=15\text{A}$, $di_F/dt=1000\text{A}/\mu\text{s}$, $T_j=125^\circ\text{C}$		-	124	-	
$V_R=400\text{V}$, $I_F=15\text{A}$, $di_F/dt=1000\text{A}/\mu\text{s}$, $T_j=150^\circ\text{C}$		-	131	-	
Peak reverse current	I_{rrm}				A
$V_R=400\text{V}$, $I_F=15\text{A}$, $di_F/dt=1000\text{A}/\mu\text{s}$, $T_j=25^\circ\text{C}$		-	13.7	-	
$V_R=400\text{V}$, $I_F=15\text{A}$, $di_F/dt=1000\text{A}/\mu\text{s}$, $T_j=125^\circ\text{C}$		-	16.4	-	
$V_R=400\text{V}$, $I_F=15\text{A}$, $di_F/dt=1000\text{A}/\mu\text{s}$, $T_j=150^\circ\text{C}$		-	19.3	-	
Reverse recovery charge	Q_{rr}				nC
$V_R=400\text{V}$, $I_F=15\text{A}$, $di_F/dt=1000\text{A}/\mu\text{s}$, $T_j=25^\circ\text{C}$		-	595	-	
$V_R=400\text{V}$, $I_F=15\text{A}$, $di_F/dt=1000\text{A}/\mu\text{s}$, $T_j=125^\circ\text{C}$		-	995	-	
$V_R=400\text{V}$, $I_F=15\text{A}$, $di_F/dt=1000\text{A}/\mu\text{s}$, $T_j=150^\circ\text{C}$		-	1104	-	
Reverse recovery softness factor	S				
$V_R=400\text{V}$, $I_F=15\text{A}$, $di_F/dt=1000\text{A}/\mu\text{s}$, $T_j=25^\circ\text{C}$		-	3.6	-	
$V_R=400\text{V}$, $I_F=15\text{A}$, $di_F/dt=1000\text{A}/\mu\text{s}$, $T_j=125^\circ\text{C}$		-	4.3	-	
$V_R=400\text{V}$, $I_F=15\text{A}$, $di_F/dt=1000\text{A}/\mu\text{s}$, $T_j=150^\circ\text{C}$		-	4.5	-	

1 Power dissipation

$$P_{\text{tot}} = f(T_C)$$

parameter: $T_j \leq 175^\circ\text{C}$

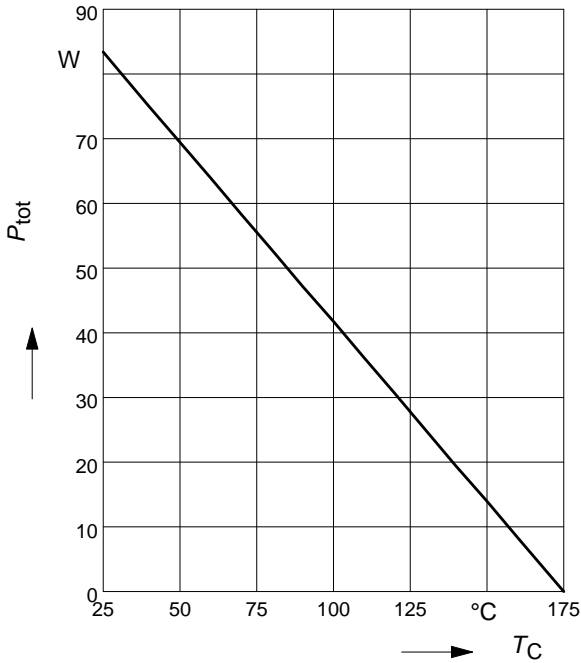

2 Diode forward current

$$I_F = f(T_C)$$

parameter: $T_j \leq 175^\circ\text{C}$

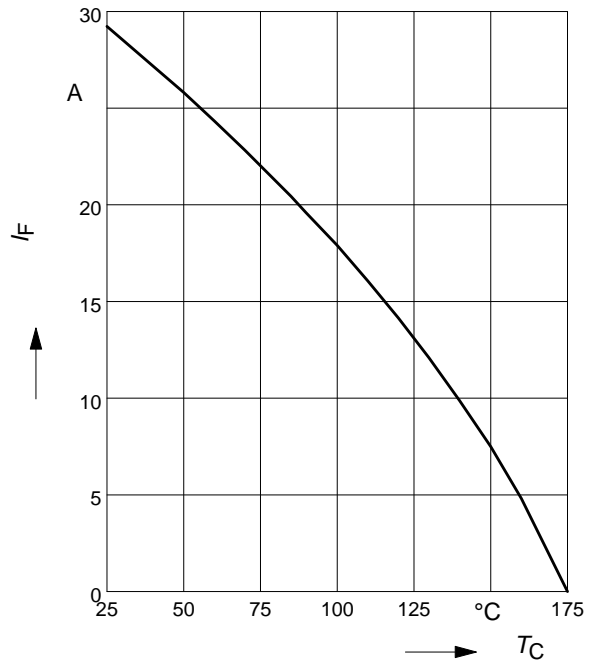

3 Typ. diode forward current

$$I_F = f(V_F)$$

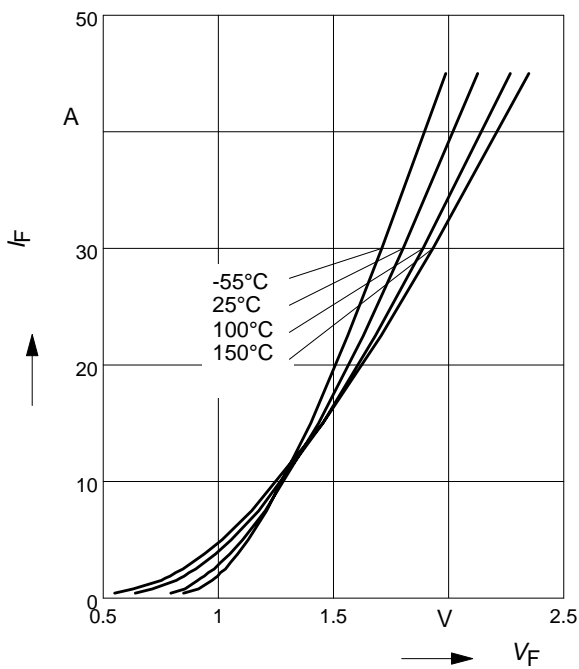

4 Typ. diode forward voltage

$$V_F = f(T_j)$$

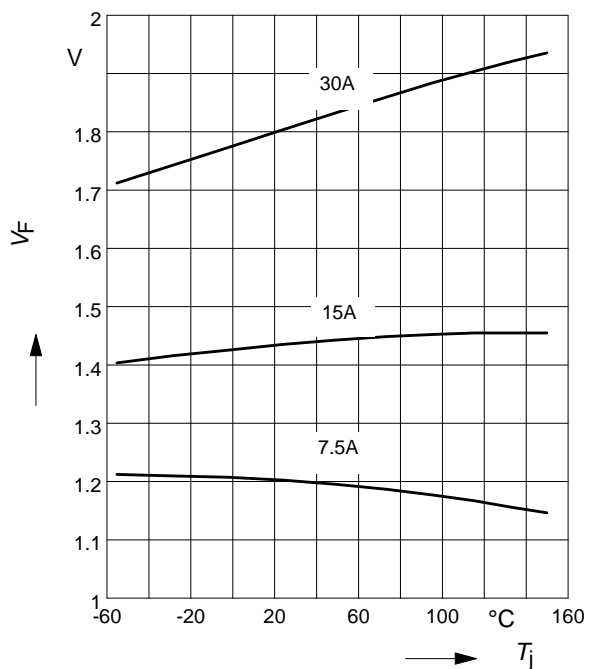

5 Typ. reverse recovery time

$$t_{rr} = f(di_F/dt)$$

parameter: $V_R = 400V, T_j = 125^\circ C$

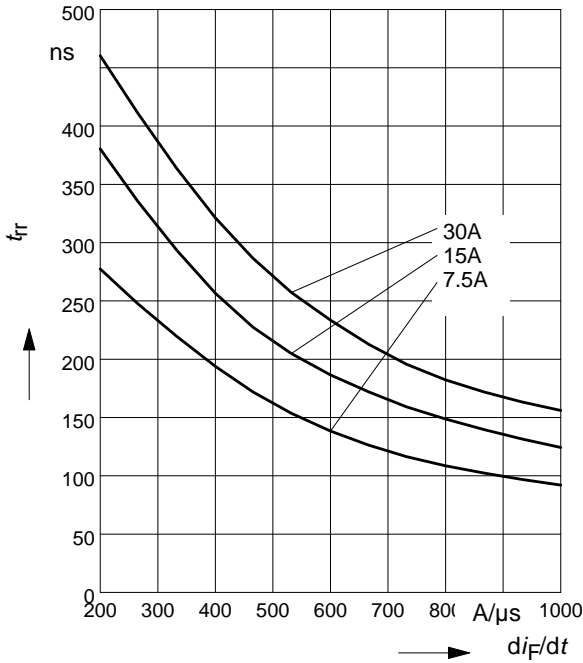

6 Typ. reverse recovery charge

$$Q_{rr} = f(di_F/dt)$$

parameter: $V_R = 400V, T_j = 125^\circ C$

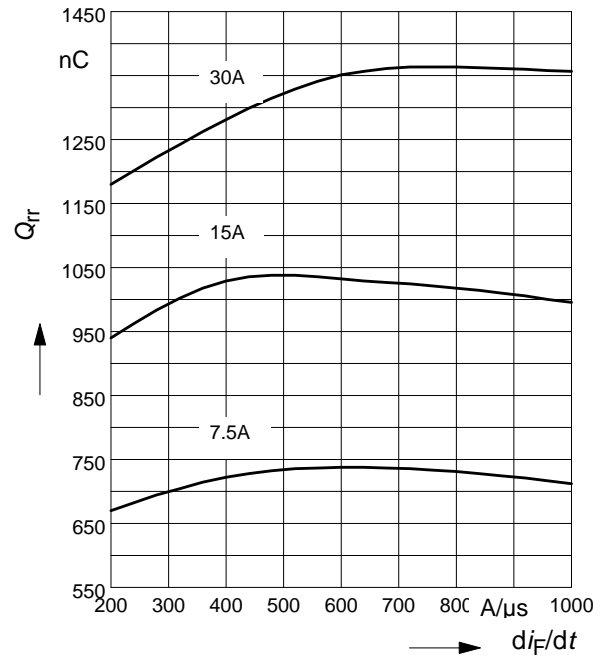

7 Typ. reverse recovery current

$$I_{rr} = f(di_F/dt)$$

parameter: $V_R = 400V, T_j = 125^\circ C$

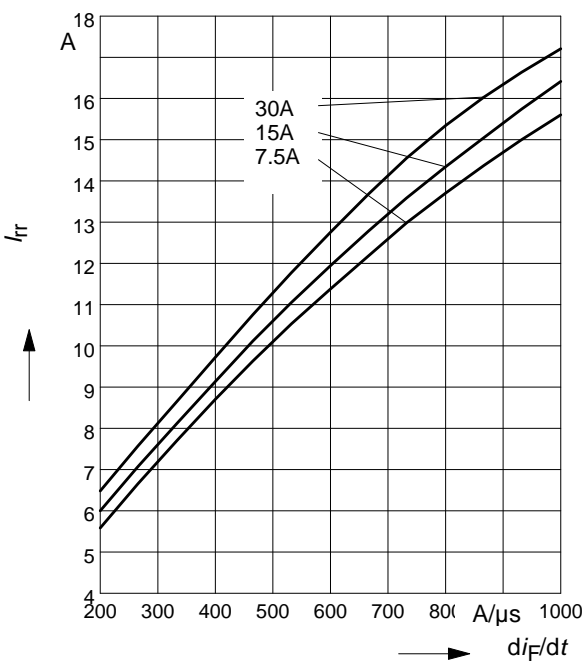

8 Typ. reverse recovery softness factor

$$S = f(di_F/dt)$$

parameter: $V_R = 400V, T_j = 125^\circ C$

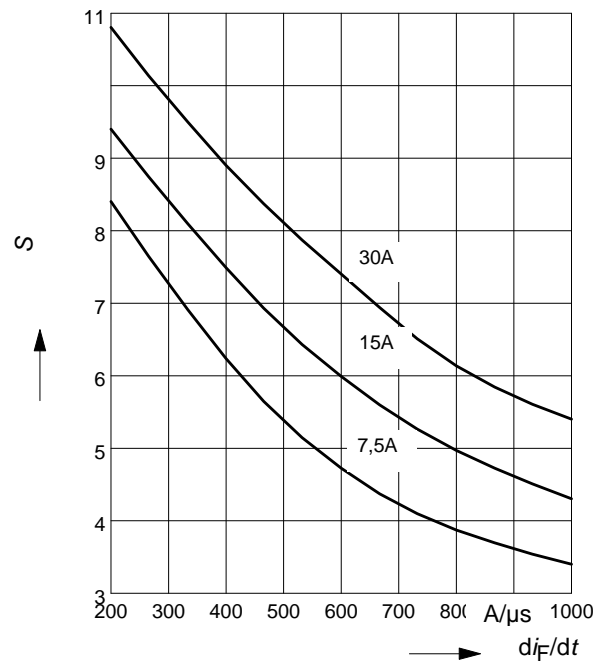

9 Max. transient thermal impedance

$$Z_{thJC} = f(t_p)$$

parameter : $D = t_p/T$

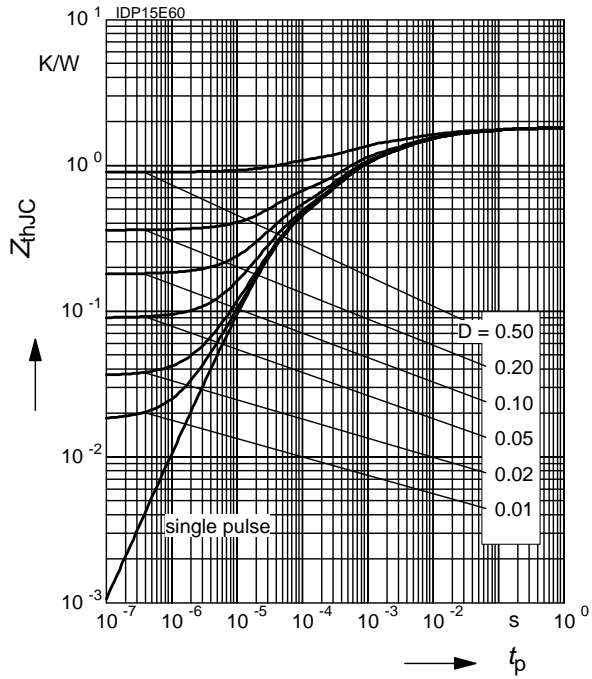

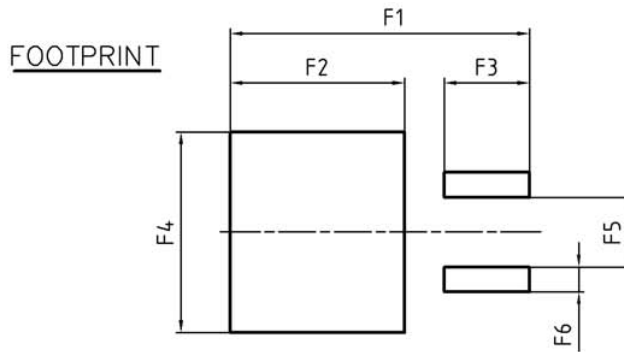
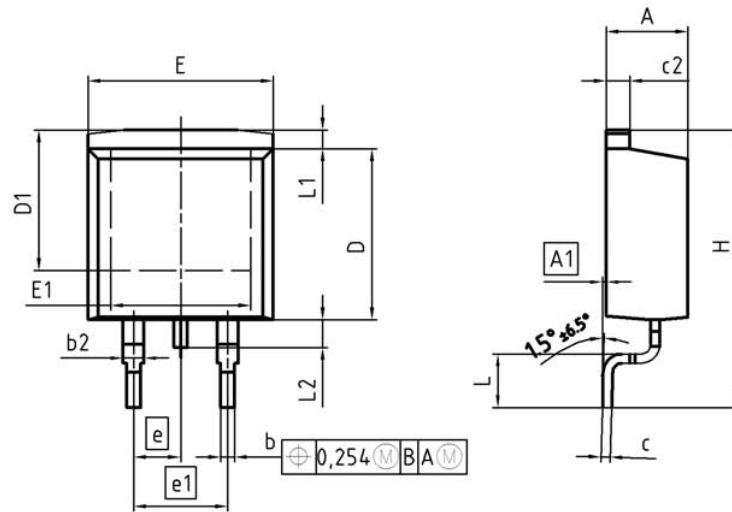

DIM	MILLIMETERS		INCHES	
	MIN	MAX	MIN	MAX
A	4.30	4.57	0.169	0.180
A1	0.00	0.25	0.000	0.010
b	0.65	0.85	0.026	0.033
b2	0.95	1.15	0.037	0.045
c	0.33	0.65	0.013	0.026
c2	1.17	1.40	0.046	0.055
D	8.51	9.45	0.335	0.372
D1	7.10	7.90	0.280	0.311
E	9.80	10.31	0.386	0.406
E1	6.50	8.60	0.256	0.339
e	2.54		0.100	
e1	5.08		0.200	
N	2		2	
H	14.61	15.88	0.575	0.625
L	2.29	3.00	0.090	0.118
L1	0.70	1.60	0.028	0.063
L2	1.00	1.78	0.039	0.070
F1	16.05	16.25	0.632	0.640
F2	9.30	9.50	0.366	0.374
F3	4.50	4.70	0.177	0.185
F4	10.70	10.90	0.421	0.429
F5	3.65	3.85	0.144	0.152
F6	1.25	1.45	0.049	0.057

DOCUMENT NO.
Z8B00003324

SCALE

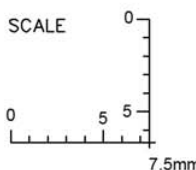

EUROPEAN PROJECTION

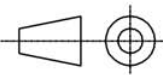

ISSUE DATE
30-08-2007

REVISION
01

Published by
Infineon Technologies AG,
Bereichs Kommunikation
St.-Martin-Strasse 53,
D-81541 München
© Infineon Technologies AG 1999
All Rights Reserved.

Attention please!

The information herein is given to describe certain components and shall not be considered as warranted characteristics.

Terms of delivery and rights to technical change reserved.

We hereby disclaim any and all warranties, including but not limited to warranties of non-infringement, regarding circuits, descriptions and charts stated herein.

Infineon Technologies is an approved CECC manufacturer.

Information

For further information on technology, delivery terms and conditions and prices please contact your nearest Infineon Technologies Office in Germany or our Infineon Technologies Representatives worldwide (see address list).

Warnings

Due to technical requirements components may contain dangerous substances.

For information on the types in question please contact your nearest Infineon Technologies Office.

Infineon Technologies Components may only be used in life-support devices or systems with the express written approval of Infineon Technologies, if a failure of such components can reasonably be expected to cause the failure of that life-support device or system, or to affect the safety or effectiveness of that device or system. Life support devices or systems are intended to be implanted in the human body, or to support and/or maintain and sustain and/or protect human life. If they fail, it is reasonable to assume that the health of the user or other persons may be endangered.