

Aluminum Capacitors Radial Miniature, Low Impedance

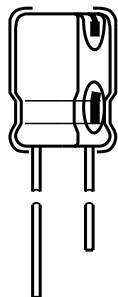
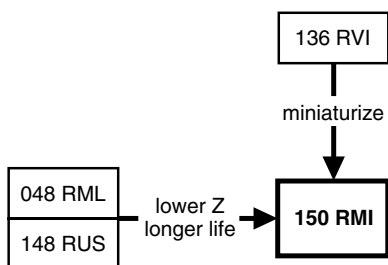

Fig.1 Component outline



FEATURES

- Polarized aluminum electrolytic capacitors, non-solid electrolyte
- Radial leads, cylindrical aluminum case with pressure relief, insulated with a blue vinyl sleeve
- Charge and discharge proof
- Very long useful life: 4000 to 10 000 h at 105 °C, high stability, high reliability
- Very low impedance or ESR respectively, at smaller case sizes than the 136 RVI series
- Excellent ripple current capability
- Lead (Pb)-free versions are RoHS compliant



RoHS
COMPLIANT

APPLICATIONS

- Power supplies (SMPS, DC/DC converters) for general industrial, EDP, audio-video, automotive and telecommunications
- Smoothing, filtering, buffering

MARKING

The capacitors are marked (where possible) with the following information:

- Rated capacitance (in μF)
- Tolerance on rated capacitance, code letter in accordance with IEC 60062 (M for $\pm 20\%$)
- Rated voltage (in V)
- Date code, in accordance with IEC 60062
- Code indicating factory of origin.
- Name of manufacturer
- Upper category temperature (105 °C)
- Negative terminal identification
- Series number (150)

QUICK REFERENCE DATA	
DESCRIPTION	VALUE
Nominal case sizes ($\varnothing D \times L$ in mm)	8 x 12 to 18 x 31
Rated capacitance range, C_R	100 to 6800 μF
Tolerance on C_R	$\pm 20\%$
Rated voltage range, U_R	10 to 100 V
Category temperature range	- 55 to + 105 °C
Endurance test at 105 °C	3000 to 5000 hours
Useful life at 105 °C	4000 to 10 000 hours
Useful life at 40 °C, $1.8 \times I_R$ applied	200 000 to 500 000 hours
Shelf life at 0 V, 105 °C	1000 hours
Based on sectional specification	IEC 60384-4/EN130300
Climatic category IEC 60068	55/105/56

SELECTION CHART FOR C_R , U_R AND RELEVANT NOMINAL CASE SIZES ($\varnothing D \times L$ in mm)							
C_R (μF)	U_R (V)						
	10	16	25	35	50	63	100
22	-	-	-	-	-	-	8 x 12
47	-	-	-	-	-	8 x 12	-
100	-	-	-	8 x 12	-	10 x 12	-
150	-	-	-	-	10 x 12	10 x 16	-
220	-	8 x 12	8 x 12	8 x 15	10 x 16	10 x 20	-
	-	-	-	10 x 12	-	-	-
330	-	8 x 12	10 x 12	10 x 16	10 x 20	12.5 x 20	18 x 20
470	8 x 12	8 x 15	10 x 16	10 x 20	12.5 x 20	12.5 x 25	-
	-	10 x 12	-	-	-	16 x 20	-
680	10 x 12	10 x 16	10 x 20	12.5 x 20	12.5 x 25	16 x 20	-
	-	-	-	-	-	16 x 25	-
1000	10 x 16	10 x 20	12.5 x 20	12.5 x 25	16 x 25	16 x 31	-
	-	-	-	16 x 20	-	-	-
1200	-	-	-	-	16 x 31	-	-

SELECTION CHART FOR C_R, U_R AND RELEVANT NOMINAL CASE SIZES ($\varnothing D \times L$ in mm)							
C_R (μF)	U_R (V)						
	10	16	25	35	50	63	100
1500	-	12.5 x 20	12.5 x 25	16 x 20	16 x 31	-	-
	-	-	-	12.5 x 35	-	-	-
2200	12.5 x 20	12.5 x 25	16 x 20	16 x 31	-	-	-
	-	-	12.5 x 35	-	-	-	-
3300	12.5 x 25	16 x 20	16 x 31	18 x 31	-	-	-
4700	16 x 25	16 x 31	16 x 35	-	-	-	-
6800	16 x 31	16 x 35	-	-	-	-	-

DIMENSIONS in millimeters AND AVAILABLE FORMS

Fig.2 Form CA: Long leads Fig.3 Form CB: Cut leads

Fig.4 Form TFA: Taped in box (ammopack)

Table 1

DIMENSIONS in millimeters, MASS AND PACKAGING QUANTITIES									
NOMINAL CASE SIZE $\varnothing D \times L$	CASE CODE	$\varnothing d$	$\varnothing D_{max.}$	$L_{max.}$	F	MASS (g)	PACKAGING QUANTITIES		
							FORM CA	FORM CB	FORM TFA
8 x 12	13	0.6	8.5	13.0	3.5 ± 0.5	≈ 1.1	5000	5000	1000
8 x 15	13L	0.6	8.5	16.0	3.5 ± 0.5	≈ 1.3	5000	5000	1000
10 x 12	14	0.6	10.5	13.5	5.0 ± 0.5	≈ 1.6	1000	500	800
10 x 16	15	0.6	10.5	17.5	5.0 ± 0.5	≈ 1.9	500	500	800
10 x 20	16	0.6	10.5	22.0	5.0 ± 0.5	≈ 2.2	500	500	800
12.5 x 20	17	0.6	13.0	22.0	5.0 ± 0.5	≈ 4.0	500	500	500
12.5 x 25	18	0.6	13.0	27.0	5.0 ± 0.5	≈ 5.0	250	250	500
12.5 x 35	18LL	0.6	13.0	37.5	5.0 ± 0.5	≈ 6.0	250	250	-
16 x 20	19a	0.8	16.5	22.0	7.5 ± 0.5	≈ 6.0	250	250	250
16 x 25	19	0.8	16.5	27.0	7.5 ± 0.5	≈ 8.0	250	250	250
16 x 31	20	0.8	16.5	33.5	7.5 ± 0.5	≈ 9.0	100	100	250
16 x 35	21	0.8	16.5	37.5	7.5 ± 0.5	≈ 11.0	100	100	-
18 x 20	1820	0.8	18.5	22.0	7.5 ± 0.5	≈ 8.0	100	100	-
18 x 31	1831	0.8	18.5	33.5	7.5 ± 0.5	≈ 12.5	100	100	-

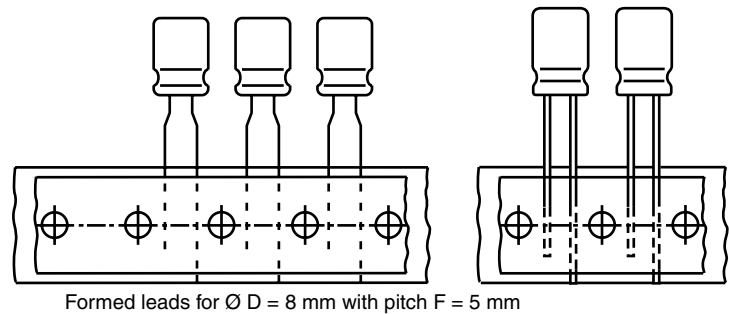
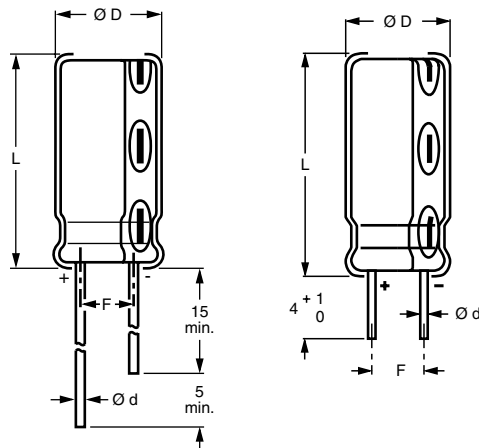

ELECTRICAL DATA	
SYMBOL	DESCRIPTION
C_R	rated capacitance at 100 Hz , tolerance $\pm 20\%$
I_R	rated RMS ripple current at 100 kHz , 105 °C
I_{L2}	max. leakage current after 2 minutes at U_R
$\tan \delta$	max. dissipation factor at 100 Hz
Z	max. impedance at 100 kHz

Note

Unless otherwise specified, all electrical values in Table 2 apply at $T_{amb} = 20\text{ °C}$, $P = 86$ to 106 kPa , $RH = 45$ to 75%

ORDERING EXAMPLE

Electrolytic capacitor 150 series
470 $\mu\text{F}/16\text{ V}$; $\pm 20\%$
Nominal case size: $\varnothing 10 \times 12\text{ mm}$; Form TFA
Ordering Code: MAL215035471E3
Former 12NC: 2222 150 35471

Table 2

ELECTRICAL DATA AND ORDERING INFORMATION										
U_R (V)	C_R 100 Hz (μF)	NOMINAL CASE SIZE $\varnothing D \times L$ (mm)	I_R 100 kHz 105 °C (mA)	I_{L2} 2 min (μA)	$\tan \delta$ 100 Hz	Z 100 kHz + 20 °C (Ω)	Z 100 kHz - 40 °C (Ω)	ORDERING CODE MAL2150.....		
								BULK PACKAGING		TAPED
								FORM CA	FORM CB	FORM TFA
10	470	8 x 12	555	47	0.19	0.117	0.870	54471E3	84471E3	34471E3
	680	10 x 12	730	71	0.19	0.097	0.680	54681E3	64681E3	34681E3
	1000	10 x 16	950	103	0.19	0.066	0.460	54102E3	64102E3	34102E3
	2200	12.5 x 20	1460	223	0.21	0.037	0.260	54222E3	64222E3	34222E3
	3300	12.5 x 25	1950	333	0.21	0.029	0.200	54332E3	64332E3	34332E3
	4700	16 x 25	2390	473	0.23	0.022	0.150	54472E3	64472E3	34472E3
	6800	16 x 31	2890	683	0.25	0.019	0.130	54682E3	64682E3	34682E3
16	220	8 x 12	555	35	0.16	0.117	0.870	55221E3	85221E3	35221E3
	330	8 x 12	555	53	0.16	0.117	0.870	55331E3	85331E3	35331E3
	470	8 x 15	730	78	0.16	0.085	0.750	95475E3	95478E3	95473E3
	470	10 x 12	730	78	0.16	0.097	0.680	55471E3	65471E3	35471E3
	680	10 x 16	950	112	0.16	0.066	0.460	55681E3	65681E3	35681E3
	1000	10 x 20	1180	163	0.16	0.049	0.340	55102E3	65102E3	35102E3
	1500	12.5 x 20	1460	243	0.16	0.037	0.260	55152E3	65152E3	35152E3
	2200	12.5 x 25	1950	355	0.18	0.029	0.200	55222E3	65222E3	35222E3
	3300	16 x 20	1840	531	0.20	0.028	0.200	55332E3	65332E3	35332E3
25	4700	16 x 31	2890	755	0.22	0.019	0.130	55472E3	65472E3	35472E3
	6800	16 x 35	3100	1091	0.24	0.018	0.130	55682E3	65682E3	-
	220	8 x 12	555	55	0.14	0.117	0.870	56221E3	86221E3	36221E3
	330	10 x 12	730	86	0.14	0.097	0.680	56331E3	66331E3	36331E3
	470	10 x 16	950	121	0.14	0.066	0.460	56471E3	66471E3	36471E3
	680	10 x 20	1180	173	0.14	0.049	0.340	56681E3	66681E3	36681E3
	1000	12.5 x 20	1460	253	0.14	0.037	0.260	56102E3	66102E3	36102E3
	1500	12.5 x 25	1950	378	0.14	0.029	0.200	56152E3	66152E3	36152E3
	2200	12.5 x 35	2510	553	0.16	0.028	0.200	96225E3	96226E3	-
35	2200	16 x 20	1840	553	0.16	0.028	0.200	56222E3	66222E3	36222E3
	3300	16 x 31	2890	828	0.16	0.019	0.130	56332E3	66332E3	36332E3
	4700	16 x 35	3100	1178	0.18	0.018	0.130	56472E3	66472E3	-
	100	8 x 12	555	35	0.12	0.117	0.870	50101E3	80101E3	30101E3
	220	8 x 15	730	77	0.12	0.085	0.750	90225E3	90228E3	90223E3
	220	10 x 12	730	80	0.12	0.097	0.680	50221E3	60221E3	30221E3
	330	10 x 16	950	118	0.12	0.066	0.460	50331E3	60331E3	30331E3
	470	10 x 20	1180	167	0.12	0.049	0.340	50471E3	60471E3	30471E3
	680	12.5 x 20	1460	241	0.12	0.037	0.260	50681E3	60681E3	30681E3
50	1000	12.5 x 25	1950	353	0.12	0.029	0.200	50102E3	60102E3	30102E3
	1000	16 x 20	1840	353	0.12	0.028	0.200	90105E3	90106E3	90103E3
	1500	12.5 x 35	2510	528	0.12	0.028	0.200	90186E3	90187E3	-
	1500	16 x 20	1840	528	0.12	0.028	0.200	50152E3	60152E3	30152E3
	2200	16 x 31	2890	773	0.14	0.019	0.130	50222E3	60222E3	30222E3
	3300	18 x 31	3000	1155	0.16	0.019	0.130	50332E3	60332E3	-
	150	10 x 12	500	78	0.10	0.200	1.400	51151E3	61151E3	31151E3
	220	10 x 16	700	113	0.10	0.120	0.840	51221E3	61221E3	31221E3
	330	10 x 20	900	168	0.10	0.090	0.630	51331E3	61331E3	31331E3



ELECTRICAL DATA AND ORDERING INFORMATION										
U _R (V)	C _R 100 Hz (μF)	NOMINAL CASE SIZE Ø D x L (mm)	I _R 100 kHz 105 °C (mA)	I _{L2} 2 min (μA)	tan δ 100 Hz	Z 100 kHz + 20 °C (Ω)	Z 100 kHz - 40 °C (Ω)	ORDERING CODE MAL2150.....		
								BULK PACKAGING		TAPED
								FORM CA	FORM CB	FORM TFA
63	47	8 x 12	405	30	0.09	0.342	2.350	58479E3	88479E3	38479E3
	100	10 x 12	420	66	0.10	0.270	1.890	58101E3	68101E3	38101E3
	150	10 x 16	560	97	0.10	0.190	1.330	58151E3	68151E3	38151E3
	220	10 x 20	700	141	0.10	0.150	1.050	58221E3	68221E3	38221E3
	330	12.5 x 20	930	211	0.10	0.095	0.670	58331E3	68331E3	38331E3
	470	12.5 x 25	1200	299	0.10	0.067	0.470	58471E3	68471E3	38471E3
	470	16 x 20	1100	299	0.10	0.074	0.520	98475E3	98476E3	98473E3
	680	16 x 20	1100	431	0.10	0.074	0.520	58681E3	68681E3	38681E3
	680	16 x 25	1500	431	0.10	0.054	0.380	98685E3	98686E3	98683E3
	1000	16 x 31	1900	633	0.10	0.042	0.295	58102E3	68102E3	38102E3
100	22	8 x 12	230	22	0.08	0.68	27.0	59229E3	89229E3	39229E3
	330	18 x 20	1700	330	0.07	0.074	2.0	90183E3	90185E3	-

ADDITIONAL ELECTRICAL DATA		
PARAMETER	CONDITIONS	VALUE
Voltage		
Surge voltage		U _s ≤ 1.15 x U _R
Reverse voltage		U _{rev} ≤ 1 V
Current		
Leakage current	After 2 minutes at U _R	I _{L2} ≤ 0.01 C _R x U _R + 3 μA
Inductance		
Equivalent series inductance (ESL)	Case Ø D ≤ 10 mm	typ. 16 nH
	Case Ø D ≥ 12.5 mm	typ. 18 nH
Resistance		
Equivalent series resistance (ESR)	Calculated from tan δ _{max} and C _R (see Table 2)	ESR = tan δ/2 π f C _R

CAPACITANCE (C)

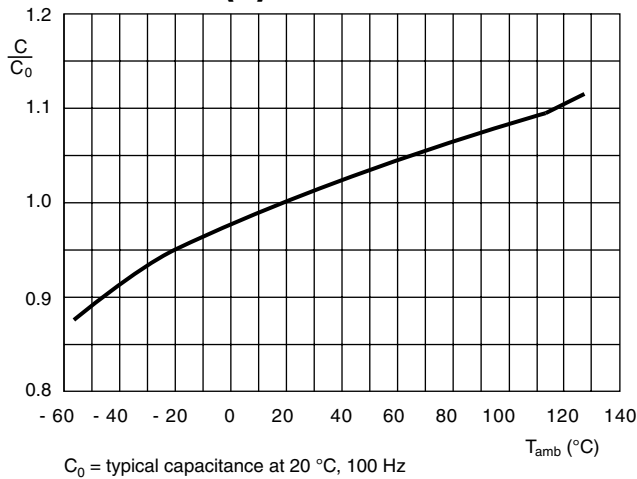

Fig.5 Typical multiplier of capacitance as a function of ambient temperature

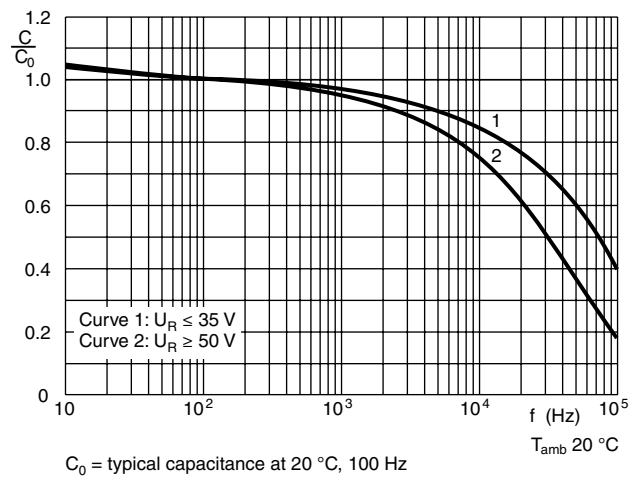

Fig.6 Typical multiplier of capacitance as a function of frequency

EQUIVALENT SERIES RESISTANCE (ESR)

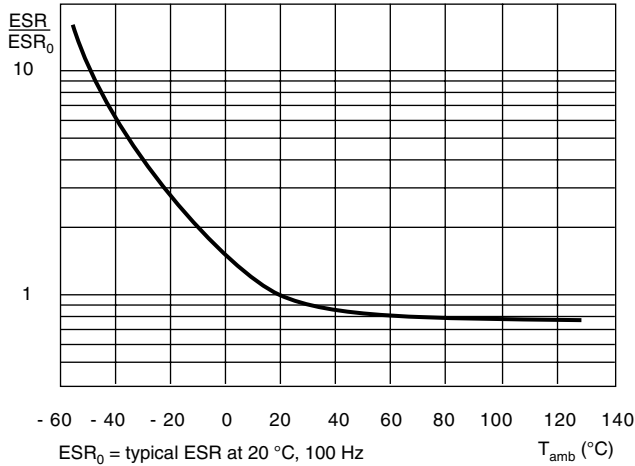

Fig.7 Typical multiplier of ESR as a function of ambient temperature

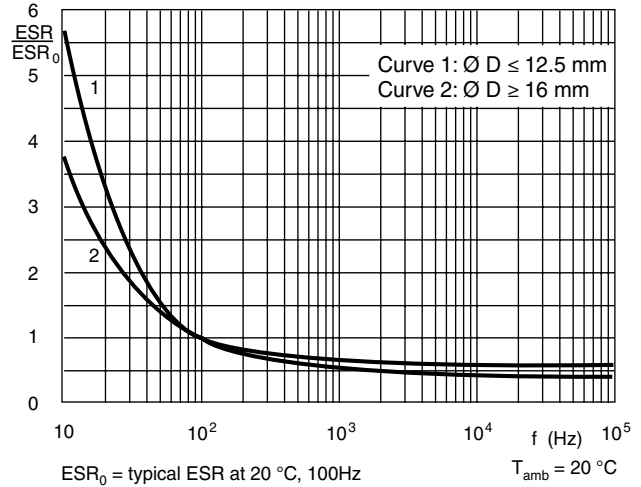

Fig.8 Typical multiplier of ESR as a function of frequency

IMPEDANCE (Z)

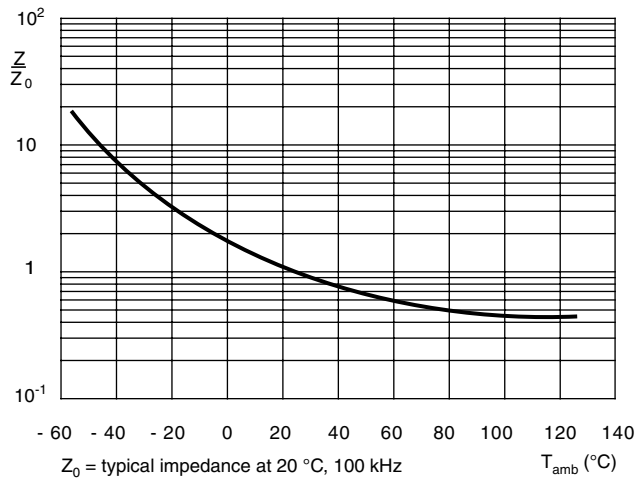

Fig.9 Typical multiplier of impedance as a function of ambient temperature

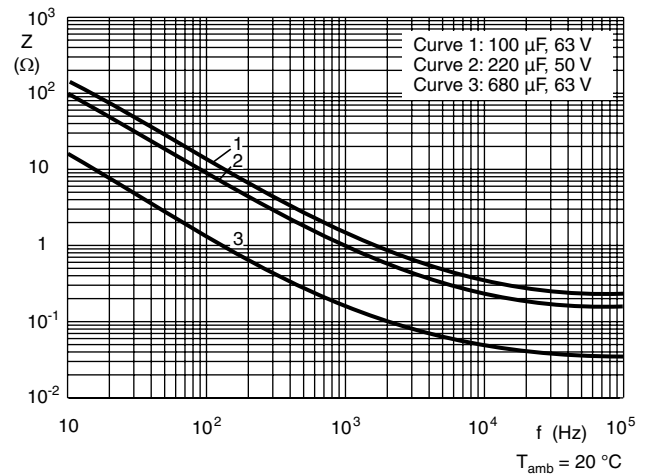

Fig.11 Typical impedance as a function of frequency

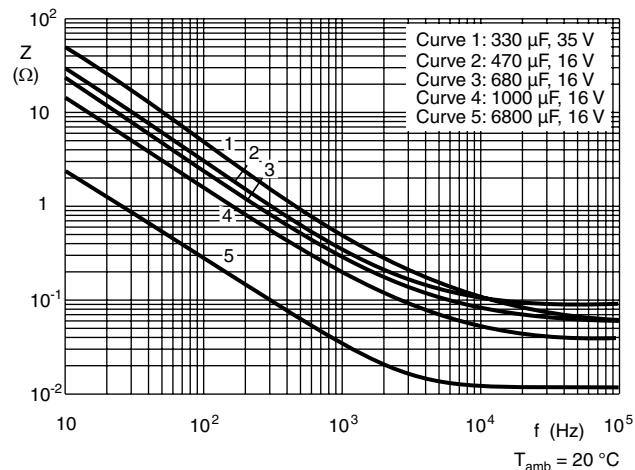
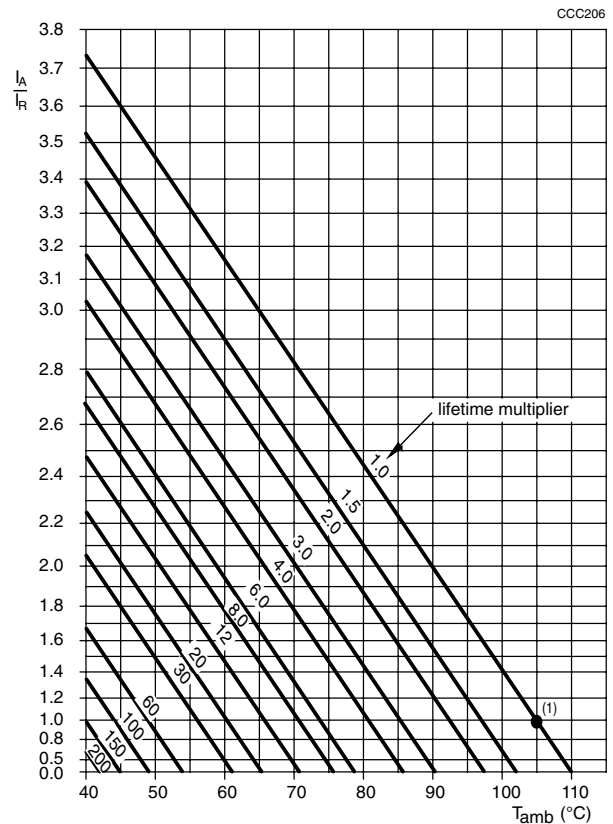

Fig.10 Typical impedance as a function of frequency

RIPPLE CURRENT AND USEFUL LIFE

Table 3

ENDURANCE TEST DURATION AND USEFUL LIFE AS A FUNCTION OF CASE SIZE			
NOMINAL CASE SIZE Ø D x L (mm)	CASE CODE	ENDURANCE at 105 °C (h)	USEFUL LIFE at 105 °C (h)
8 x 12	13	3000	4000
8 x 15	13L	3000	4000
10 x 12	14	3000	4000
10 x 16	15	3000	6000
10 x 20	16	3000	6000
12.5 x 20	17	3000	7000
12.5 x 25	18	5000	8000
12.5 x 35	18LL	5000	8000
16 x 20	19a	3000	7000
16 x 25	19	5000	10 000
16 x 31	20	5000	10 000
16 x 35	21	5000	10 000
18 x 20	1820	3000	7000
18 x 31	1831	6000	10 000



I_A = actual ripple current at 100 kHz
 I_R = rated ripple current at 100 kHz, 105 °C
 (1) Useful life at 105 °C and I_R applied; see Table 4

Fig.12 Multiplier of useful life as a function of ambient temperature and ripple current load

Table 4

MULTIPLIER OF RIPPLE CURRENT (I_R) AS A FUNCTION OF FREQUENCY		
FREQUENCY (Hz)	I_R MULTIPLIER	
	$\varnothing = 8$ to 12.5 mm	$\varnothing = 16$ mm and 18 mm
100	0.65	0.76
300	0.76	0.85
1000	0.85	0.91
3000	0.89	0.94
10 000	0.90	0.96
30 000	0.97	0.98
100 000	1.00	1.00

Table 5

TEST PROCEDURES AND REQUIREMENTS			
TEST		PROCEDURE (quick reference)	REQUIREMENTS
NAME OF TEST	REFERENCE		
Endurance	IEC 60384-4/ EN130300 subclause 4.13	$T_{amb} = 105$ °C; U_R applied; for test duration see Table 3	$\Delta C/C: \pm 20$ % $\tan \delta \leq 2$ x spec. limit $I_{L2} \leq$ spec. limit
Useful life	CECC 30301 subclause 1.8.1	$T_{amb} = 105$ °C; U_R and I_R applied; for test duration see Table 3	$\Delta C/C: \pm 30$ % $\tan \delta \leq 3$ x spec. limit $I_{L2} \leq$ spec. limit no short or open circuit total failure percentage: ≤ 1 %
Shelf life (storage at high temperature)	IEC 60384-4/ EN130300 subclause 4.17	$T_{amb} = 105$ °C; no voltage applied; 1000 h after test: U_R to be applied for 30 min., 24 to 48 h before measurement	$\Delta C/C: \pm 20$ % $\tan \delta \leq 2$ x spec. limit $I_{L2} \leq$ spec. limit



Disclaimer

All product specifications and data are subject to change without notice.

Vishay Intertechnology, Inc., its affiliates, agents, and employees, and all persons acting on its or their behalf (collectively, "Vishay"), disclaim any and all liability for any errors, inaccuracies or incompleteness contained herein or in any other disclosure relating to any product.

Vishay disclaims any and all liability arising out of the use or application of any product described herein or of any information provided herein to the maximum extent permitted by law. The product specifications do not expand or otherwise modify Vishay's terms and conditions of purchase, including but not limited to the warranty expressed therein, which apply to these products.

No license, express or implied, by estoppel or otherwise, to any intellectual property rights is granted by this document or by any conduct of Vishay.

The products shown herein are not designed for use in medical, life-saving, or life-sustaining applications unless otherwise expressly indicated. Customers using or selling Vishay products not expressly indicated for use in such applications do so entirely at their own risk and agree to fully indemnify Vishay for any damages arising or resulting from such use or sale. Please contact authorized Vishay personnel to obtain written terms and conditions regarding products designed for such applications.

Product names and markings noted herein may be trademarks of their respective owners.