

74F675A 16-Bit Serial-In, Serial/Parallel-Out Shift Register

General Description

The 74F675A contains a 16-bit serial in/serial out shift register and a 16-bit parallel out storage register. Separate serial input and output pins are provided for expansion to longer words. By means of a separate clock, the contents of the shift register are transferred to the storage register. The contents of the storage register can also be loaded back into the shift register. A HIGH signal on the Chip Select input prevents both shifting and parallel loading.

Features

- Serial-to-parallel converter
- 16-Bit serial I/O shift register
- 16-Bit parallel out storage register
- Recirculating parallel transfer
- Expandable for longer words
- Slim 24 lead package
- 74F675A version prevents false clocking through CS or R/W inputs

Ordering Code:

| Order Number | Package Number | Package Description |
|--------------|----------------|---|
| 74F675ASC | M24B | 24-Lead Small Outline Integrated Circuit (SOIC), JEDEC MS-013, 0.300 Wide |
| 74F675APC | N24A | 24-Lead Plastic Dual-In-Line Package (PDIP), JEDEC MS-010, 0.600 Wide |
| 74F675ASPC | N24C | 24-Lead Plastic Dual-In-Line Package (PDIP), JEDEC MS-100, 0.300 Wide |

Devices also available in Tape and Reel. Specify by appending the suffix letter "X" to the ordering code.

Logic Symbols

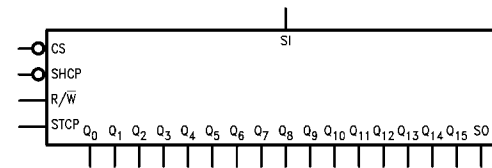
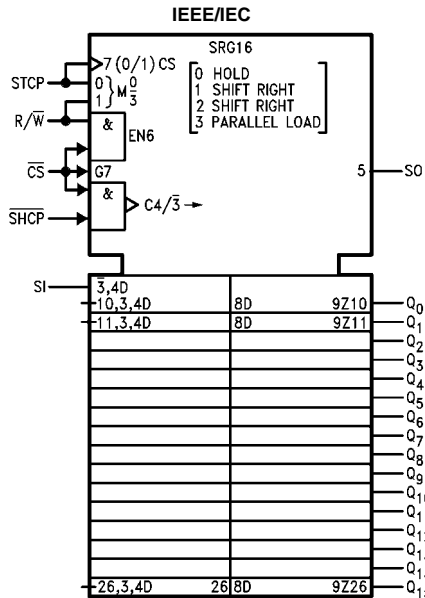

Connection Diagram

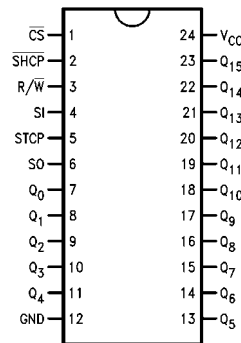

Unit Loading/Fan Out

| Pin Names | Description | U.L. HIGH/LOW | Input I_{IH}/I_{IL} Output I_{OH}/I_{OL} |
|-----------------------------|---|------------------|---|
| SI | Serial Data Input | 1.0/1.0 | 20 μ A/-0.6 mA |
| \overline{CS} | Chip Select Input (Active LOW) | 1.0/1.0 | 20 μ A/-0.6 mA |
| \overline{SHCP} | Shift Clock Pulse Input (Active Falling Edge) | 1.0/1.0 | 20 μ A/-0.6 mA |
| STCP | Store Clock Pulse Input (Active Rising Edge) | 1.0/1.0 | 20 μ A/-0.6 mA |
| $\overline{R/\overline{W}}$ | Read/Write Input | 1.0/1.0 | 20 μ A/-0.6 mA |
| SO | Serial Data Output | 50/33.3 | -1 mA/20 mA |
| Q_0-Q_{15} | Parallel Data Outputs | 50/33.3 | -1 mA/20 mA |

Functional Description

The 16-Bit shift register operates in one of four modes, as determined by the signals applied to the Chip Select (\overline{CS}), Read/Write ($\overline{R/\overline{W}}$) and Store Clock Pulse (STCP) input. State changes are indicated by the falling edge of the Shift Clock Pulse (\overline{SHCP}). In the Shift Right mode, data enters D_0 from the Serial Input (SI) pin and exits from Q_{15} via the Serial Data Output (SO) pin. In the Parallel Load mode, data from the storage register outputs enter the shift register and serial shifting is inhibited.

The storage register is in the Hold mode when either \overline{CS} or $\overline{R/\overline{W}}$ is HIGH. With \overline{CS} and $\overline{R/\overline{W}}$ both LOW, the storage register is parallel loaded from the shift register on the rising edge of STCP.

To prevent false clocking of the shift register, \overline{SHCP} should be in the LOW state during a LOW-to-HIGH transition of \overline{CS} . To prevent false clocking of the storage register, STCP should be LOW during a HIGH-to-LOW transition of \overline{CS} if $\overline{R/\overline{W}}$ is LOW, and should also be LOW during a HIGH-to-LOW transition of $\overline{R/\overline{W}}$ if \overline{CS} is LOW.

Shift Register Operations Table

| Control Inputs | | | | Operating Mode |
|-----------------|-----------------------------|-------------------|------|-------------------------------|
| \overline{CS} | $\overline{R/\overline{W}}$ | \overline{SHCP} | STCP | |
| H | X | X | X | Hold |
| L | L | \sim | X | Shift Right |
| L | H | \sim | L | Shift Right |
| L | H | \sim | H | Parallel Load, No Shifting |

Storage Register Operations Table

| Inputs | | | Operating Mode |
|-----------------|-----------------------------|------------|-------------------|
| \overline{CS} | $\overline{R/\overline{W}}$ | STCP | |
| H | X | X | Hold |
| L | H | X | Hold |
| L | L | \swarrow | Parallel Load |

H = HIGH Voltage Level
L = LOW Voltage Level
X = Immaterial
 \sim = HIGH-to-LOW Transition
 \swarrow = LOW-to-HIGH Transition

Logic Diagram

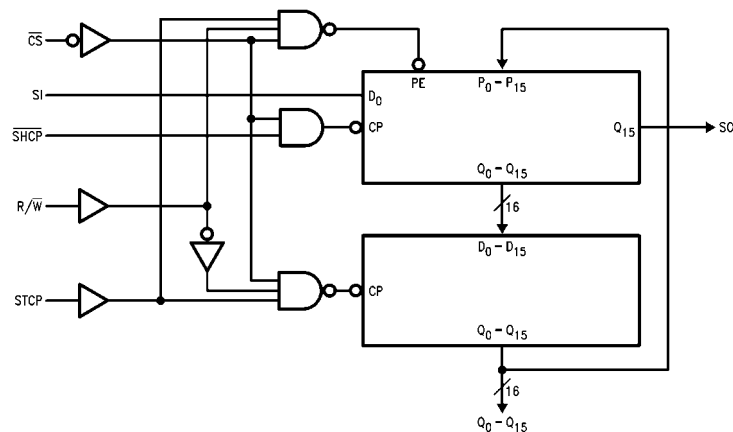

Please note that this diagram is provided only for the understanding of logic operations and should not be used to estimate propagation delays.

Absolute Maximum Ratings(Note 1)

| | |
|--|--------------------------------------|
| Storage Temperature | -65°C to +150°C |
| Ambient Temperature under Bias | -55°C to +125°C |
| Junction Temperature under Bias | -55°C to +150°C |
| V _{CC} Pin Potential to Ground Pin | -0.5V to +7.0V |
| Input Voltage (Note 2) | -0.5V to +7.0V |
| Input Current (Note 2) | -30 mA to +5.0 mA |
| Voltage Applied to Output in HIGH State (with V _{CC} = 0V) | |
| Standard Output | -0.5V to V _{CC} |
| 3-STATE Output | -0.5V to +5.5V |
| Current Applied to Output in LOW State (Max) | twice the rated I _{OL} (mA) |

Recommended Operating Conditions

| | |
|------------------------------|----------------|
| Free Air Ambient Temperature | 0°C to +70°C |
| Supply Voltage | +4.5V to +5.5V |

Note 1: Absolute maximum ratings are values beyond which the device may be damaged or have its useful life impaired. Functional operation under these conditions is not implied.

Note 2: Either voltage limit or current limit is sufficient to protect inputs.

DC Electrical Characteristics

| Symbol | Parameter | Min | Typ | Max | Units | V _{CC} | Conditions |
|------------------|-----------------------------------|---|------------|------|-------|-----------------|--|
| V _{IH} | Input HIGH Voltage | 2.0 | | | V | | Recognized as a HIGH Signal |
| V _{IL} | Input LOW Voltage | | | 0.8 | V | | Recognized as a LOW Signal |
| V _{CD} | Input Clamp Diode Voltage | | | -1.2 | V | Min | I _{IN} = -18 mA |
| V _{OH} | Output HIGH Voltage | 10% V _{CC} 5% V _{CC} | 2.5 2.7 | | V | Min | I _{OH} = -1 mA I _{OH} = -1 mA |
| V _{OL} | Output LOW Voltage | 10% V _{CC} | | 0.5 | V | Min | I _{OL} = 20 mA |
| I _{IH} | Input HIGH Current | | | 5.0 | μA | Max | V _{IN} = 2.7V |
| I _{BVI} | Input HIGH Current Breakdown Test | | | 7.0 | μA | Max | V _{IN} = 7.0V |
| I _{CEX} | Output HIGH Leakage Current | | | 50 | μA | Max | V _{OUT} = V _{CC} |
| V _{ID} | Input Leakage Test | 4.75 | | | V | 0.0 | I _{ID} = 1.9 μA All Other Pins Grounded |
| I _{OD} | Output Leakage Circuit Current | | | 3.75 | μA | 0.0 | V _{IOD} = 150 mV All Other Pins Grounded |
| I _{IL} | Input LOW Current | | | -0.6 | mA | Max | V _{IN} = 0.5V |
| I _{OS} | Output Short-Circuit Current | -60 | | -150 | mA | Max | V _{OUT} = 0V |
| I _{CCH} | Power Supply Current | | 106 | 160 | mA | Max | V _O = HIGH |
| I _{CCL} | Power Supply Current | | 106 | 160 | mA | Max | V _O = LOW |

| AC Electrical Characteristics | | | | | | | |
|-------------------------------|---|---|------|--|--|-------|-------|
| Symbol | Parameter | T _A = +25°C V _{CC} = +5.0V C _L = 50 pF | | | T _A = 0°C to +70°C V _{CC} = +5.0V C _L = 50 pF | | Units |
| | | Min | Typ | Max | Min | Max | |
| f _{MAX} | Maximum Clock Frequency | 100 | 130 | | 85 | | MHz |
| t _{PLH} | Propagation Delay | 3.0 | 8.0 | 10.5 | 2.5 | 12.0 | ns |
| t _{PHL} | STCP to Q _n | 3.0 | 10.5 | 13.5 | 2.5 | 15.0 | |
| t _{PLH} | Propagation Delay | 4.0 | 7.0 | 9.5 | 3.5 | 10.5 | ns |
| t _{PHL} | SHCP to SO | 4.5 | 8.0 | 10.5 | 4.0 | 12.0 | |
| AC Operating Requirements | | | | | | | |
| Symbol | Parameter | T _A = +25°C V _{CC} = +5.0V | | T _A = 0°C to +70°C V _{CC} = +5.0V | | Units | |
| | | Min | Max | Min | Max | | |
| t _S (H) | Setup Time, HIGH or LOW | 3.5 | | 4.0 | | ns | |
| t _S (L) | \overline{CS} or $\overline{R/W}$ to STCP | 5.5 | | 6.5 | | | |
| t _H (H) | Hold Time, HIGH or LOW | 0 | | 0 | | ns | |
| t _H (L) | \overline{CS} or $\overline{R/W}$ to STCP | 0 | | 0 | | | |
| t _S (H) | Setup Time, HIGH or LOW | 3.0 | | 3.5 | | ns | |
| t _S (L) | SI to SHCP | 3.0 | | 3.5 | | | |
| t _H (H) | Hold Time, HIGH or LOW | 3.0 | | 3.5 | | ns | |
| t _H (L) | SI to SHCP | 3.0 | | 3.5 | | | |
| t _S (H) | Setup Time, HIGH or LOW | 6.5 | | 7.5 | | ns | |
| t _S (L) | $\overline{R/W}$ to SHCP | 9.0 | | 10.0 | | | |
| t _H (H) | Hold Time, HIGH or LOW | 0 | | 0 | | ns | |
| t _H (L) | $\overline{R/W}$ to SHCP | 0 | | 0 | | | |
| t _S (H) | Setup Time, HIGH or LOW | 7.0 | | 8.0 | | ns | |
| t _S (L) | STCP to SHCP | 7.0 | | 8.0 | | | |
| t _H (H) | Hold Time, HIGH or LOW | 0 | | 0 | | ns | |
| t _H (L) | STCP to SHCP | 0 | | 0 | | | |
| t _S (H) | Setup Time, HIGH or LOW | 3.0 | | 3.5 | | ns | |
| t _S (L) | \overline{CS} to SHCP | 3.0 | | 3.5 | | | |
| t _H (H) | Hold Time, HIGH or LOW | 3.0 | | 3.5 | | ns | |
| t _H (L) | \overline{CS} to SHCP | 3.0 | | 3.5 | | | |
| t _W (H) | SHCP Pulse Width | 5.0 | | 6.0 | | ns | |
| t _W (L) | HIGH or LOW | 5.0 | | 6.0 | | | |
| t _W (H) | STCP Pulse Width | 6.0 | | 7.0 | | ns | |
| t _W (L) | HIGH or LOW | 5.0 | | 6.0 | | | |
| t _S (L) | SHCP to STCP | 8.0 | | 9.0 | | ns | |
| t _H (H) | SHCP to STCP | 0.0 | | 0.0 | | ns | |

Physical Dimensions inches (millimeters) unless otherwise noted

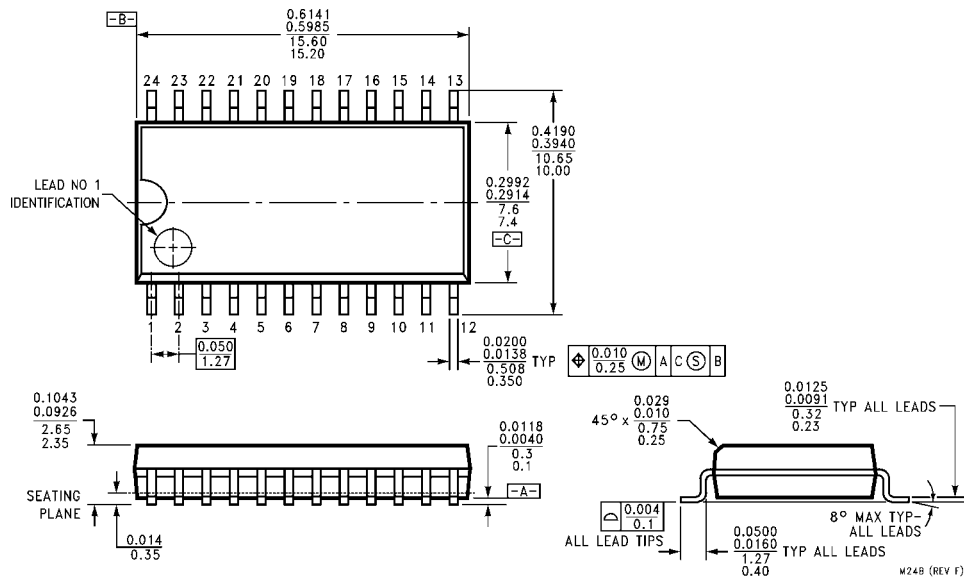

24-Lead Small Outline Integrated Circuit (SOIC), JEDEC MS-013, 0.300 Wide Package Number M24B

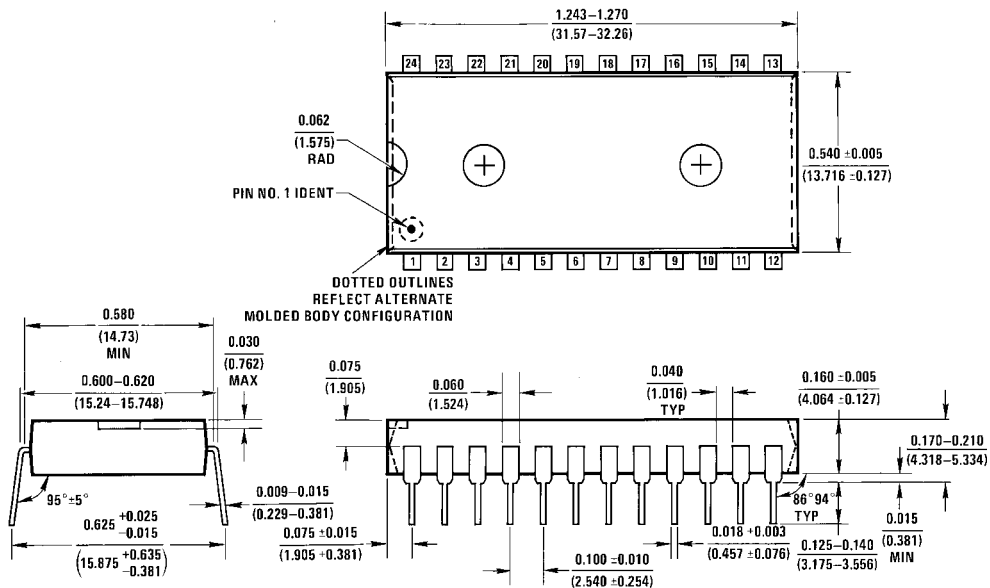

24-Lead Plastic Dual-In-Line Package (PDIP), JEDEC MS-010, 0.600 Wide Package Number N24A

Physical Dimensions inches (millimeters) unless otherwise noted (Continued)

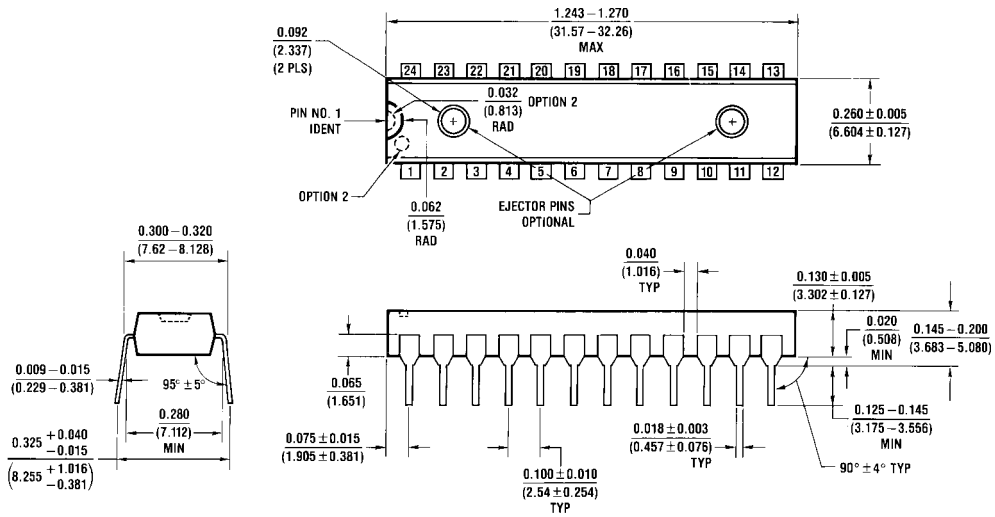

N24C (REV F)

24-Lead Plastic Dual-In-Line Package (PDIP), JEDEC MS-100, 0.300 Wide Package Number N24C

Fairchild does not assume any responsibility for use of any circuitry described, no circuit patent licenses are implied and Fairchild reserves the right at any time without notice to change said circuitry and specifications.

LIFE SUPPORT POLICY

FAIRCHILD'S PRODUCTS ARE NOT AUTHORIZED FOR USE AS CRITICAL COMPONENTS IN LIFE SUPPORT DEVICES OR SYSTEMS WITHOUT THE EXPRESS WRITTEN APPROVAL OF THE PRESIDENT OF FAIRCHILD SEMICONDUCTOR CORPORATION. As used herein:

1. Life support devices or systems are devices or systems which, (a) are intended for surgical implant into the body, or (b) support or sustain life, and (c) whose failure to perform when properly used in accordance with instructions for use provided in the labeling, can be reasonably expected to result in a significant injury to the user.
2. A critical component in any component of a life support device or system whose failure to perform can be reasonably expected to cause the failure of the life support device or system, or to affect its safety or effectiveness.

www.fairchildsemi.com