

Small Signal Schottky Diodes, Single & Dual

Features

- These diodes feature very low turn-on voltage and fast switching.
- These devices are protected by a PN junction guard ring against excessive voltage, such as electrostatic discharges.

Mechanical Data

Case: SOT-23 Plastic case

Weight: approx. 8.8 mg

Packaging Codes/Options:

GS18 / 10 k per 13" reel (8 mm tape), 10 k/box

GS08 / 3 k per 7" reel (8 mm tape), 15 k/box

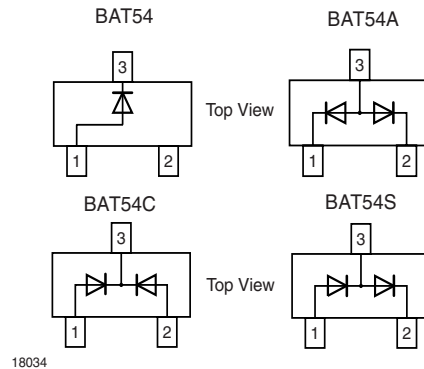
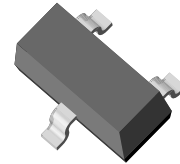

Parts Table

Part	Ordering code	Marking	Remarks
BAT54	BAT54-GS18 or BAT54-GS08	L4	Tape and Reel
BAT54A	BAT54A-GS18 or BAT54A-GS08	L42	Tape and Reel
BAT54C	BAT54C-GS18 or BAT54C-GS08	L43	Tape and Reel
BAT54S	BAT54S-GS18 or BAT54S-GS08	L44	Tape and Reel

Absolute Maximum Ratings

$T_{amb} = 25\text{ }^{\circ}\text{C}$, unless otherwise specified

Parameter	Test condition	Symbol	Value	Unit
Repetitive peak reverse voltage		V_{RRM}	30	V
Forward continuous current		I_F	200 ¹⁾	mA
Repetitive peak forward current		I_{FRM}	300 ¹⁾	mA
Surge forward current	$t_p < 1\text{ s}$	I_{FSM}	600 ¹⁾	mA
Power dissipation		P_{tot}	230	mW

¹⁾ Device on fiberglass substrate, see layout on next page.

Thermal Characteristics

$T_{amb} = 25\text{ }^{\circ}\text{C}$, unless otherwise specified

Parameter	Test condition	Symbol	Value	Unit
Thermal resistance junction to ambient air		R_{thJA}	430 ¹⁾	$^{\circ}\text{C}/\text{W}$
Junction temperature		$T_j = T_{stg}$	- 65 to + 150	$^{\circ}\text{C}$
Storage temperature range		T_s	- 65 to + 150	$^{\circ}\text{C}$

¹⁾ Device on fiberglass substrate, see layout on next page.

Electrical Characteristics

$T_{amb} = 25\text{ }^{\circ}\text{C}$, unless otherwise specified

Parameter	Test condition	Symbol	Min	Typ.	Max	Unit
Reverse Breakdown voltage	$I_R = 100\text{ }\mu\text{A}$ pulses	$V_{(BR)}$	30			V
Leakage current	Pulse test $t_p < 300\text{ }\mu\text{s}$, $\delta < 2\%$ at $V_R = 25\text{ V}$	I_R			2	μA
Forward voltage	$I_F = 0.1\text{ mA}$, $t_p < 300\text{ }\mu\text{s}$, $\delta < 2\%$	V_F			240	mV
	$I_F = 1\text{ mA}$, $t_p < 300\text{ }\mu\text{s}$, $\delta < 2\%$	V_F			320	mV
	$I_F = 10\text{ mA}$, $t_p < 300\text{ }\mu\text{s}$, $\delta < 2\%$	V_F			400	mV
	$I_F = 30\text{ mA}$, $t_p < 300\text{ }\mu\text{s}$, $\delta < 2\%$	V_F			500	mV
	$I_F = 100\text{ mA}$, $t_p < 300\text{ }\mu\text{s}$, $\delta < 2\%$	V_F			1000	mV
Diode capacitance	$V_R = 1\text{ V}$, $f = 1\text{ MHz}$	C_{tot}			10	pF
Reverse recovery time	$I_F = 10\text{ mA}$ through $I_R = 10\text{ mA}$ to $I_{rr} = 1\text{ mA}$, $R_L = 100\text{ }\Omega$	t_{rr}			5	ns

Layout for R_{thJA} test

Thickness:

Fiberglass 1.5 mm (0.059 in.)

Copper leads 0.3 mm (0.012 in.)

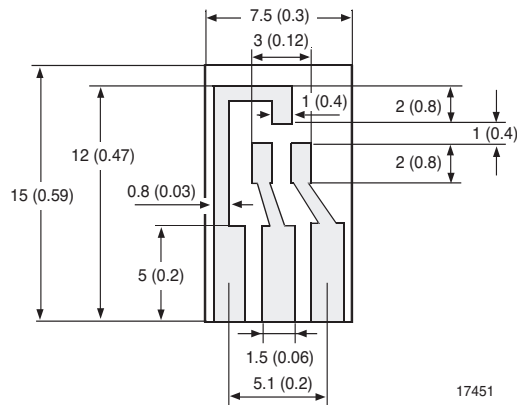

Typical Characteristics ($T_{amb} = 25\text{ }^{\circ}\text{C}$ unless otherwise specified)

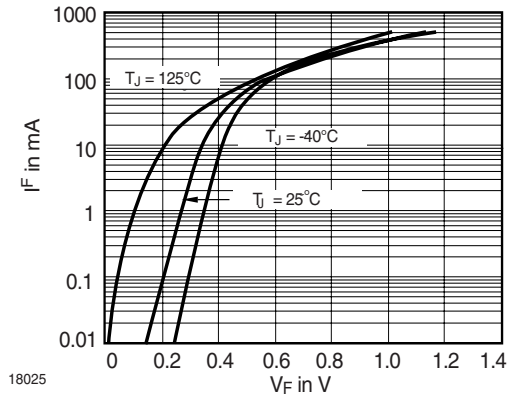

Figure 1. Typical Forward Voltage Forward Current at Various Temperatures

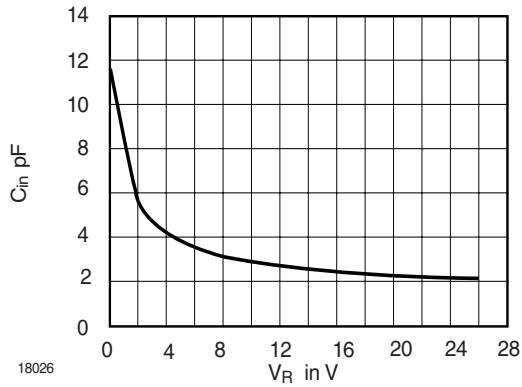

Figure 2. Typical Capacitance $^{\circ}\text{C}$ vs. Reverse Applied Voltage V_R

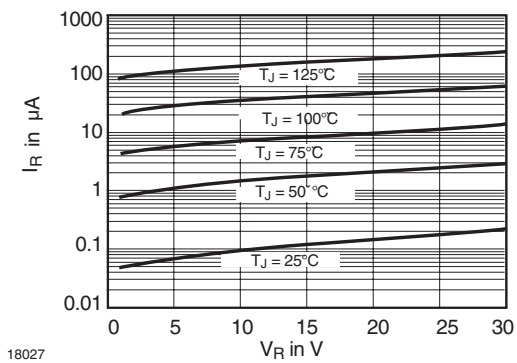

Figure 3. Typical Variation of Reverse Current at Various Temperatures

BAT54 / 54A / 54C / 54S



Vishay Semiconductors

Package Dimensions in mm (Inches)

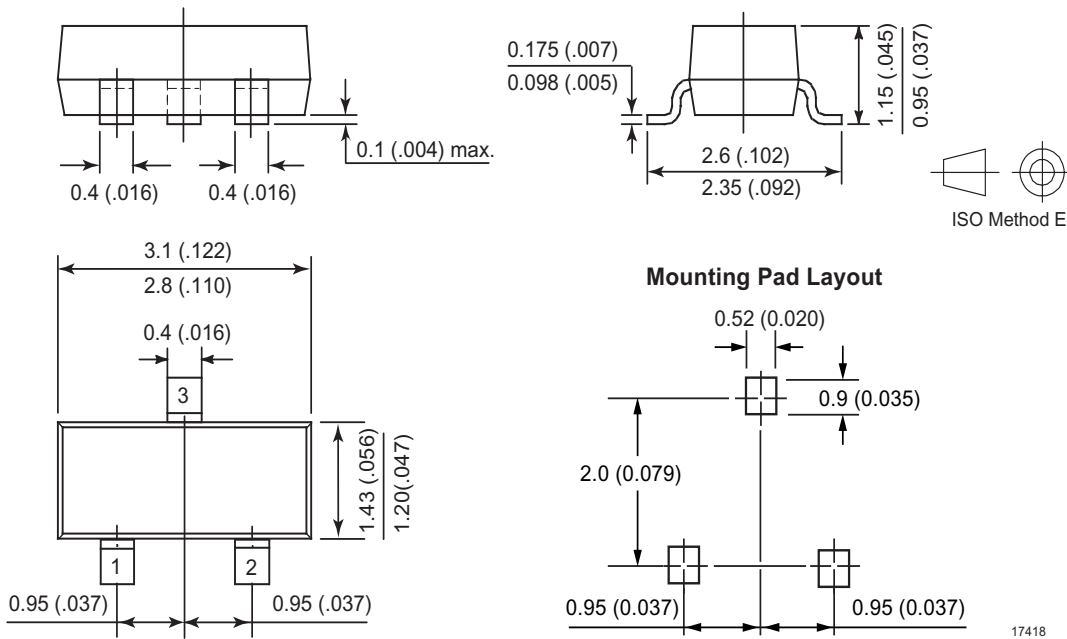



Ozone Depleting Substances Policy Statement

It is the policy of Vishay Semiconductor GmbH to

1. Meet all present and future national and international statutory requirements.
2. Regularly and continuously improve the performance of our products, processes, distribution and operating systems with respect to their impact on the health and safety of our employees and the public, as well as their impact on the environment.

It is particular concern to control or eliminate releases of those substances into the atmosphere which are known as ozone depleting substances (ODSs).

The Montreal Protocol (1987) and its London Amendments (1990) intend to severely restrict the use of ODSs and forbid their use within the next ten years. Various national and international initiatives are pressing for an earlier ban on these substances.

Vishay Semiconductor GmbH has been able to use its policy of continuous improvements to eliminate the use of ODSs listed in the following documents.

1. Annex A, B and list of transitional substances of the Montreal Protocol and the London Amendments respectively
2. Class I and II ozone depleting substances in the Clean Air Act Amendments of 1990 by the Environmental Protection Agency (EPA) in the USA
3. Council Decision 88/540/EEC and 91/690/EEC Annex A, B and C (transitional substances) respectively.

Vishay Semiconductor GmbH can certify that our semiconductors are not manufactured with ozone depleting substances and do not contain such substances.

We reserve the right to make changes to improve technical design and may do so without further notice.

Parameters can vary in different applications. All operating parameters must be validated for each customer application by the customer. Should the buyer use Vishay Semiconductors products for any unintended or unauthorized application, the buyer shall indemnify Vishay Semiconductors against all claims, costs, damages, and expenses, arising out of, directly or indirectly, any claim of personal damage, injury or death associated with such unintended or unauthorized use.

Vishay Semiconductor GmbH, P.O.B. 3535, D-74025 Heilbronn, Germany
Telephone: 49 (0)7131 67 2831, Fax number: 49 (0)7131 67 2423

Copyright © Each Manufacturing Company.

All Datasheets cannot be modified without permission.

This datasheet has been download from :

www.AllDataSheet.com

100% Free DataSheet Search Site.

Free Download.

No Register.

Fast Search System.

www.AllDataSheet.com