

Dual rectifier diodes ultrafast

BYV34 series

FEATURES

- Low forward volt drop
- Fast switching
- Soft recovery characteristic
- High thermal cycling performance
- Low thermal resistance

SYMBOL

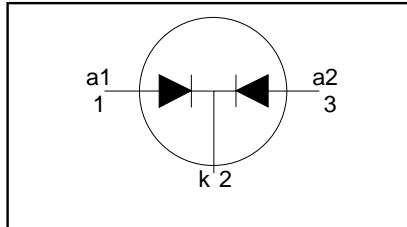

QUICK REFERENCE DATA

$$V_R = 300 \text{ V} / 400 \text{ V} / 500 \text{ V}$$

$$V_F \leq 1.05 \text{ V}$$

$$I_{O(AV)} = 20 \text{ A}$$

$$t_{rr} \leq 60 \text{ ns}$$

GENERAL DESCRIPTION

Dual, common cathode, ultra-fast, epitaxial rectifier diodes intended for use as output rectifiers in high frequency switched mode power supplies.

The BYV34 series is supplied in the conventional leaded SOT78 (TO220AB) package.

PINNING

PIN	DESCRIPTION
1	anode 1
2	cathode
3	anode 2
tab	cathode

SOT78 (TO220AB)

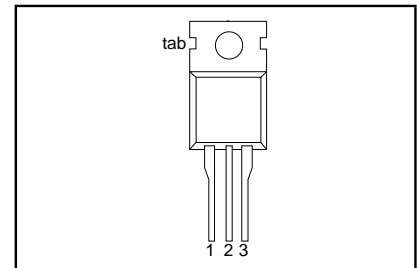

LIMITING VALUES

Limiting values in accordance with the Absolute Maximum System (IEC 134).

SYMBOL	PARAMETER	CONDITIONS	MIN.	MAX.			UNIT
				BYV34			
V_{RRM}	Peak repetitive reverse voltage	$T_{mb} \leq 138^\circ\text{C}$	-	-300	-400	-500	V
V_{RWM}	Crest working reverse voltage		-	300	400	500	V
V_R	Continuous reverse voltage		-	300	400	500	V
$I_{O(AV)}$	Average rectified output current (both diodes conducting) ¹	square wave; $\delta = 0.5$; $T_{mb} \leq 115^\circ\text{C}$	-	20			A
I_{FRM}	Repetitive peak forward current per diode	$t = 25 \mu\text{s}$; $\delta = 0.5$; $T_{mb} \leq 115^\circ\text{C}$	-	20			A
I_{FSM}	Non-repetitive peak forward current per diode.	$t = 10 \text{ ms}$	-	120			A
		$t = 8.3 \text{ ms}$ sinusoidal; with reapplied $V_{RRM(max)}$	-	132			A
T_{stg}	Storage temperature		-40	150			$^\circ\text{C}$
T_j	Operating junction temperature		-	150			$^\circ\text{C}$

THERMAL RESISTANCES

SYMBOL	PARAMETER	CONDITIONS	MIN.	TYP.	MAX.	UNIT
$R_{th\ j-hs}$	Thermal resistance junction to heatsink	per diode	-	-	2.4	K/W
$R_{th\ j-a}$	Thermal resistance junction to ambient	both diodes conducting	-	-	1.6	K/W
		in free air.	-	60	-	K/W

¹ Neglecting switching and reverse current losses

Dual rectifier diodes
ultrafast

BYV34 series

ELECTRICAL CHARACTERISTICS

characteristics are per diode at $T_j = 25^\circ\text{C}$ unless otherwise stated

SYMBOL	PARAMETER	CONDITIONS	MIN.	TYP.	MAX.	UNIT
V_F	Forward voltage	$I_F = 10\text{ A}; T_j = 150^\circ\text{C}$	-	0.87	1.05	V
		$I_F = 20\text{ A}$	-	1.10	1.35	V
I_R	Reverse current	$V_R = V_{RRM}$	-	10	50	μA
Q_s	Reverse recovery charge	$V_R = V_{RRM}; T_j = 100^\circ\text{C}$ $I_F = 2\text{ A to } V_R \geq 30\text{ V};$ $di_F/dt = 20\text{ A}/\mu\text{s}$	-	0.2	0.6	mA
t_{rr}	Reverse recovery time	$I_F = 1\text{ A to } V_R \geq 30\text{ V};$ $di_F/dt = 100\text{ A}/\mu\text{s}$	-	50	60	ns
I_{rrm}	Peak reverse recovery current	$I_F = 10\text{ A to } V_R \geq 30\text{ V};$ $di_F/dt = 50\text{ A}/\mu\text{s}; T_j = 100^\circ\text{C}$	-	4.0	5.0	A
V_{fr}	Forward recovery voltage	$I_F = 10\text{ A}; di_F/dt = 10\text{ A}/\mu\text{s}$	-	2.5	-	V

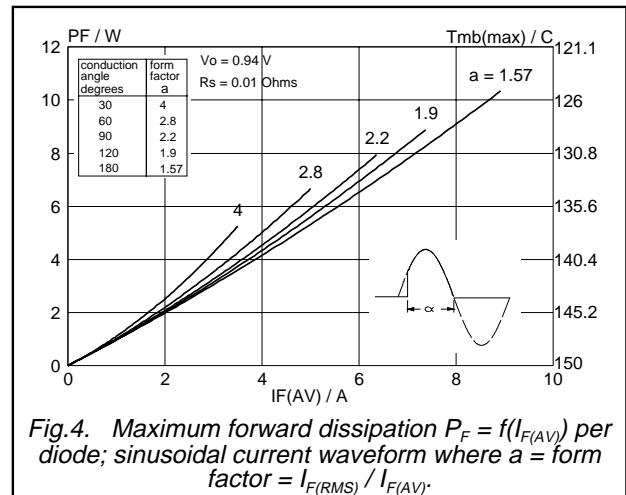
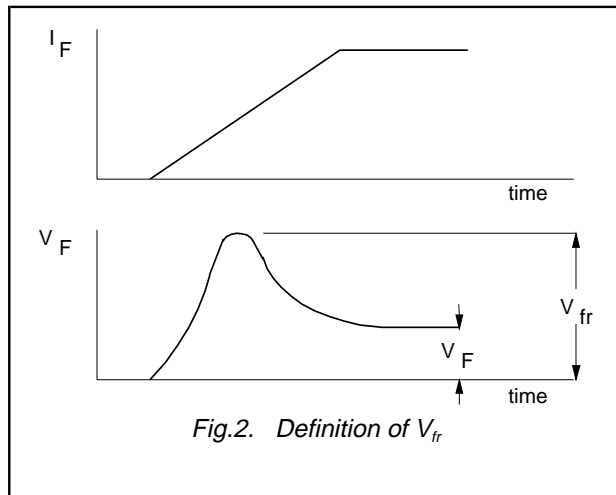
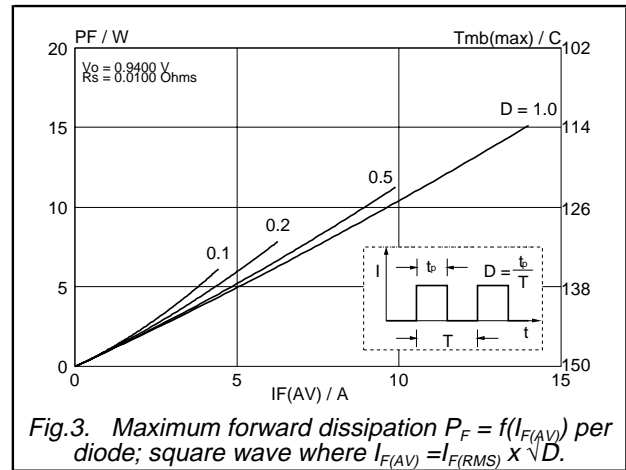
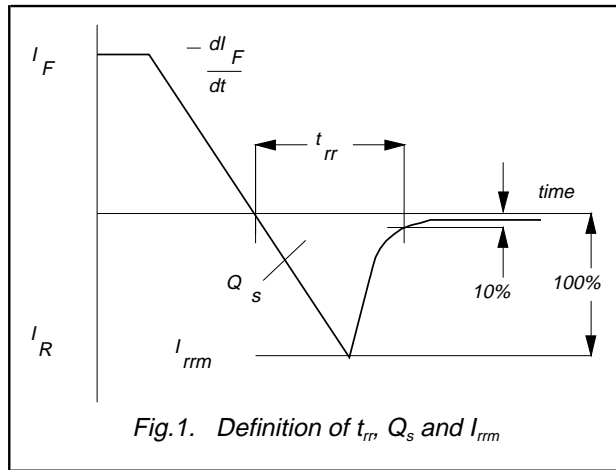

Dual rectifier diodes
ultrafast

BYV34 series

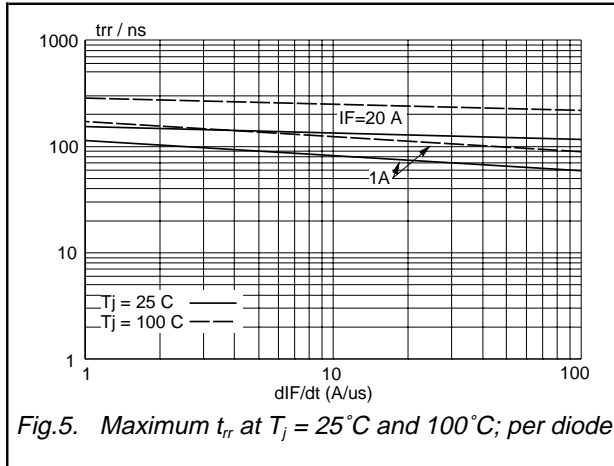

Fig.5. Maximum t_{rr} at $T_j = 25^\circ\text{C}$ and 100°C ; per diode

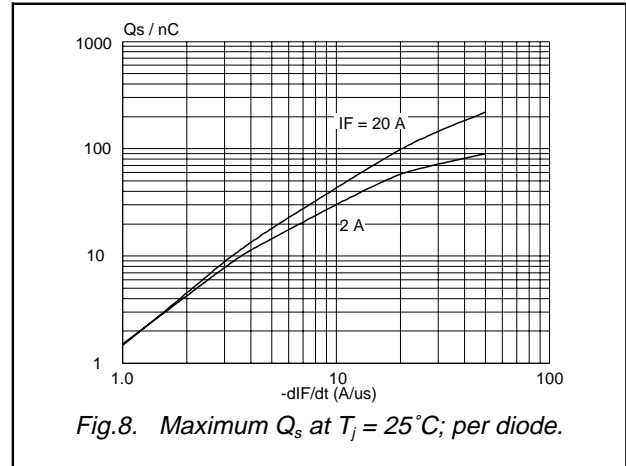

Fig.8. Maximum Q_s at $T_j = 25^\circ\text{C}$; per diode.

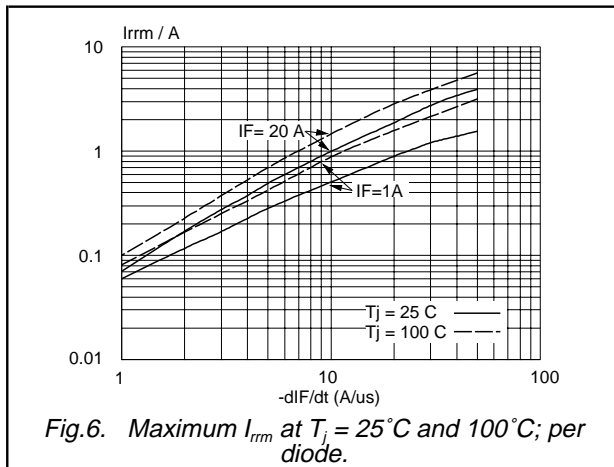

Fig.6. Maximum I_{rrm} at $T_j = 25^\circ\text{C}$ and 100°C ; per diode.

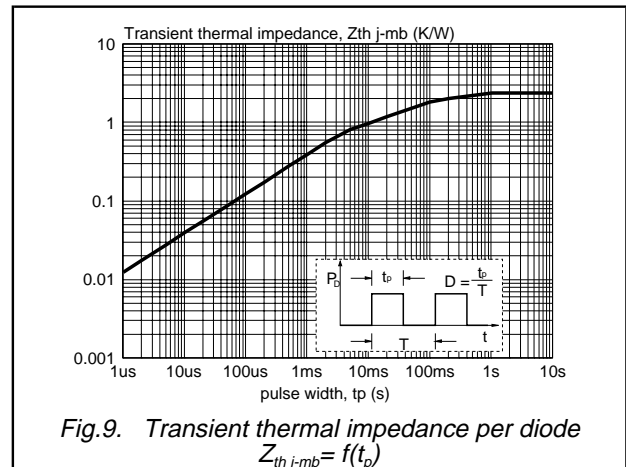

Fig.9. Transient thermal impedance per diode $Z_{th\ j-mb} = f(t_p)$

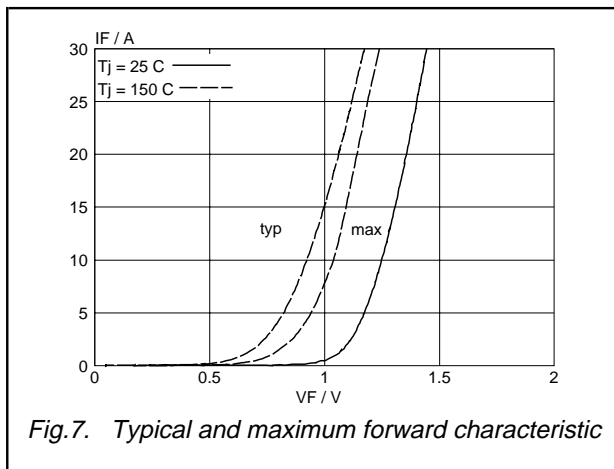

Fig.7. Typical and maximum forward characteristic

Dual rectifier diodes
ultrafast

BYV34 series

MECHANICAL DATA

Dimensions in mm

Net Mass: 2 g

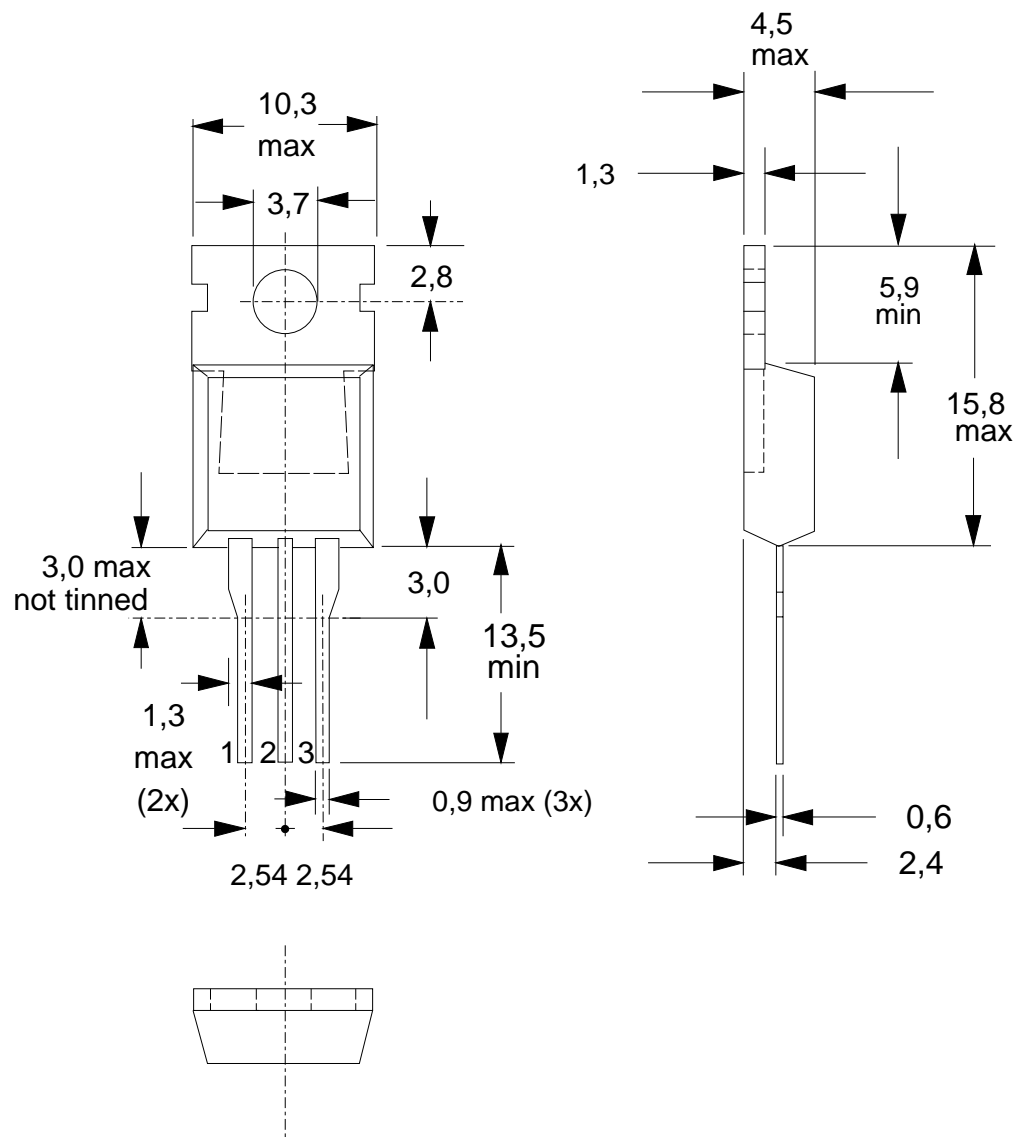

Fig.10. SOT78 (TO220AB); pin 2 connected to mounting base.

Notes

1. Refer to mounting instructions for SOT78 (TO220) envelopes.
2. Epoxy meets UL94 V0 at 1/8".

**Dual rectifier diodes
ultrafast**

BYV34 series**DEFINITIONS**

Data sheet status	
Objective specification	This data sheet contains target or goal specifications for product development.
Preliminary specification	This data sheet contains preliminary data; supplementary data may be published later.
Product specification	This data sheet contains final product specifications.
Limiting values	
Limiting values are given in accordance with the Absolute Maximum Rating System (IEC 134). Stress above one or more of the limiting values may cause permanent damage to the device. These are stress ratings only and operation of the device at these or at any other conditions above those given in the Characteristics sections of this specification is not implied. Exposure to limiting values for extended periods may affect device reliability.	
Application information	
Where application information is given, it is advisory and does not form part of the specification.	
© Philips Electronics N.V. 1998	
All rights are reserved. Reproduction in whole or in part is prohibited without the prior written consent of the copyright owner.	
The information presented in this document does not form part of any quotation or contract, it is believed to be accurate and reliable and may be changed without notice. No liability will be accepted by the publisher for any consequence of its use. Publication thereof does not convey nor imply any license under patent or other industrial or intellectual property rights.	

LIFE SUPPORT APPLICATIONS

These products are not designed for use in life support appliances, devices or systems where malfunction of these products can be reasonably expected to result in personal injury. Philips customers using or selling these products for use in such applications do so at their own risk and agree to fully indemnify Philips for any damages resulting from such improper use or sale.