



## Features

- Lead free as standard
- RoHS compliant\*
- Leadless
- High speed

## Applications

- Cellular phones
- PDAs
- Desktop PCs and notebooks
- Digital cameras
- MP3 players

 CD0805-xxxx products are currently available, although not recommended for new designs. Use CD1005-xxxx products as an alternative.

# Switching Chip Diode Series - 0805 / 1206

## General Information

The markets of portable communications, computing and video equipment are challenging the semiconductor industry to develop increasingly smaller electronic components.

Bourns offers small-signal high-speed Switching Diodes for switching digital signal applications, in compact chip package 0805 and 1206 size format, which offer PCB real estate savings and are considerably smaller than competitive parts. The Switching Diodes offer a forward current of 100 mA or 150 mA, a reverse voltage of 80 V or 75 V and also have a low leakage reverse current option. The diodes are lead-free with Cu/Ni/Au plated terminations and are compatible with lead-free manufacturing processes, conforming to many industry and government regulations on lead-free components.

Bourns® Chip Diodes conform to JEDEC standards, easy to handle on standard pick and place equipment and their flat configuration makes roll away much more difficult.

## Electrical Characteristics (@ T<sub>A</sub> = 25 °C Unless Otherwise Noted)

Parameter	Symbol	CDxxxx-S0180	CDxxxx-S01575	CDxxxx-S0180R	Unit
Forward Voltage (Max.)	V <sub>F</sub>	1.00 (I <sub>f</sub> = 100 mA)	1.00 (I <sub>f</sub> = 50 mA)	1.00 (I <sub>f</sub> = 100 mA)	V
Capacitance Between Terminals (Max.)	C <sub>T</sub>	3 (f = 100 MHz, V <sub>r</sub> = 1 V DC)			pF
Reverse Recovery Time (Max.)	t <sub>rr</sub>	4 (V <sub>r</sub> = 6V, I <sub>f</sub> = 10 mA, R <sub>L</sub> = 50 Ω)			nS
Reverse Current (Max.)	I <sub>R</sub>	0.1 (V <sub>r</sub> = 80 V)	2.5 (V <sub>r</sub> = 75 V)	0.05 (V <sub>r</sub> = 75 V)	μA

## Absolute Ratings (@ T<sub>A</sub> = 25 °C Unless Otherwise Noted)

Parameter	Symbol	CDxxxx-S0180	CDxxxx-S01575	CDxxxx-S0180R	Unit
Repetitive Peak Reverse Voltage	V <sub>RRM</sub>	90	100	90	V
Reverse Voltage	V <sub>R</sub>	80	75	80	V
Average Forward Current	I <sub>o</sub>	100	150	100	mA
Forward Current, Surge Peak	I <sub>surge</sub>	1*	4**	1*	A
Power Dissipation	PD	300	350	300	mW
Storage Temperature	T <sub>STG</sub>	-55 to +125			°C
Junction Temperature	T <sub>J</sub>	-55 to +125			°C

\* Condition: 8.3 ms single half sine-wave superimposed on rate load (JEDEC method).

\*\* Condition: 1.0 μs single half sine-wave superimposed on rate load (JEDEC method).

## How To Order

Common Code	CD 0805 - S 01 80 R
Chip Diode	
Package	
• 0805	
• 1206	
Model	S = High Speed Switching
Average Forward Current (I <sub>o</sub> ) Code	01 = 100 mA 015 = 150 mA (Code x 1000 mA = Average Forward Current)
Reverse Voltage (V <sub>R</sub> ) Code	80 = 80 V 75 = 75 V
Reverse Current Suffix	R = Low Leakage I <sub>R</sub> (CDxxxx-S0180R)

\*RoHS Directive 2002/95/EC Jan 27 2003 including Annex Specifications are subject to change without notice. Customers should verify actual device performance in their specific applications.

# Switching Chip Diode Series - 0805 / 1206

**BOURNS®**

## Product Dimensions

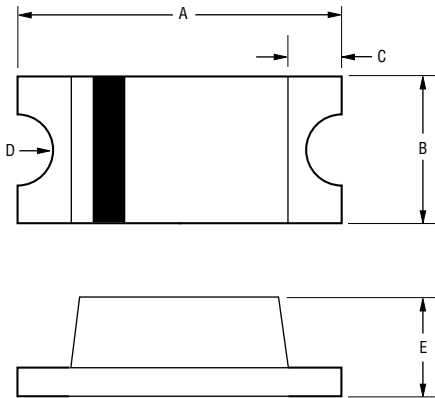

Dimension	0805	1206
A	$\frac{2.00 - 2.20}{(0.079 - 0.087)}$	$\frac{3.00 - 3.20}{(0.118 - 0.126)}$
B	$\frac{1.20 - 1.40}{(0.047 - 0.055)}$	$\frac{1.40 - 1.60}{(0.055 - 0.063)}$
C	$\frac{0.40}{(0.016)}$ Typ.	$\frac{0.50}{(0.020)}$ Typ.
D	$\frac{0.20}{(0.008)}$ R Typ.	$\frac{0.25}{(0.010)}$ R Typ.
E	$\frac{0.90 - 1.10}{(0.035 - 0.043)}$	$\frac{0.90 - 1.10}{(0.035 - 0.043)}$

DIMENSIONS:  $\frac{\text{MM}}{\text{(INCHES)}}$

## Recommended Pad Layout

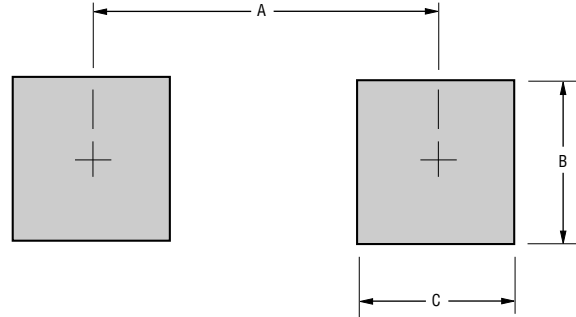

Dimension	0805	1206
A (Max.)	$\frac{2.10}{(0.082)}$	$\frac{3.00}{(0.118)}$
B (Min.)	$\frac{1.20}{(0.047)}$	$\frac{1.60}{(0.063)}$
C (Min.)	$\frac{1.20}{(0.047)}$	$\frac{1.40}{(0.055)}$

DIMENSIONS:  $\frac{\text{MM}}{\text{(INCHES)}}$

## Physical Specifications

Case .....0805(2012) / 1206(3216) Molded plastic  
 Terminals .....Solder plated, solderable per MIL-STD-750,  
 Method 2026  
 Polarity .....Indicated by cathode band  
 Mounting Position .....Any

## Typical Part Marking

CDxxxx-S0180 .....S1  
 CDxxxx-S01575 .....S3  
 CDxxxx-S0180R .....S2

Specifications are subject to change without notice.  
 Customers should verify actual device performance in their specific applications.

# Switching Chip Diode Series - 0805 / 1206

**BOURNS®**

## Rating and Characteristic Curves: CDxxxx-S0180

### Forward Characteristics

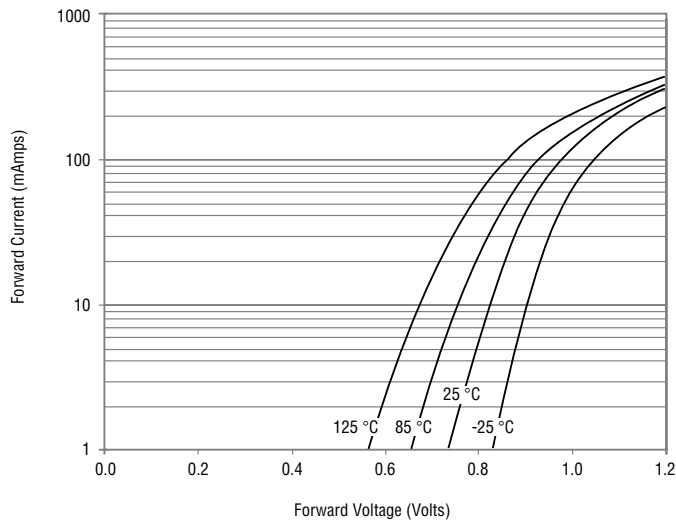

### Reverse Characteristics

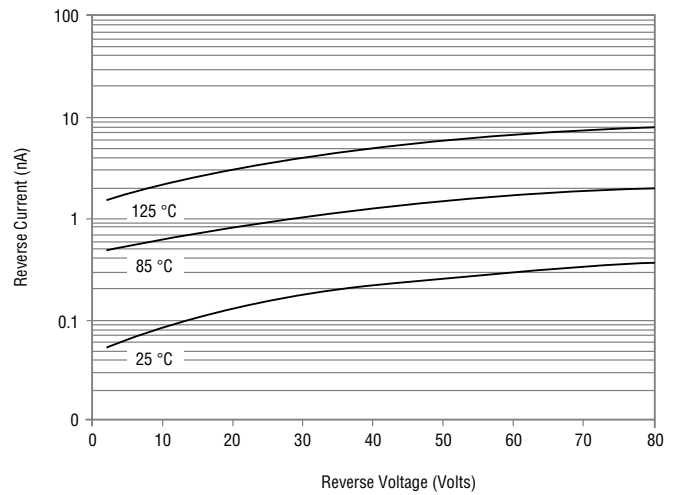

### Derating Curve

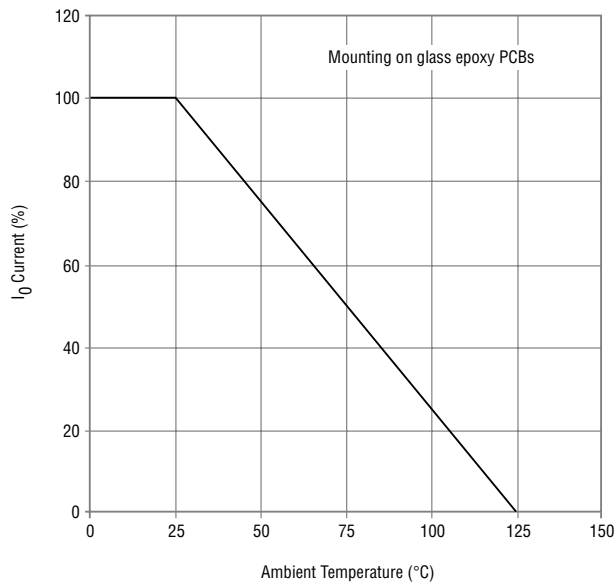

### Capacitance Between Terminals

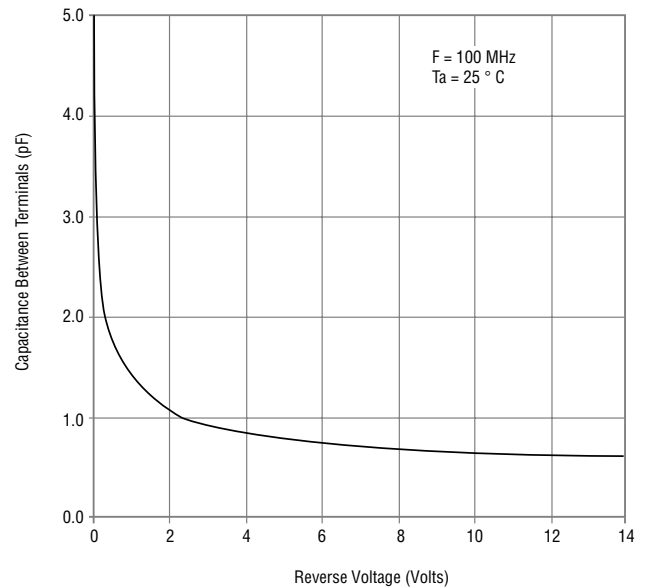

Specifications are subject to change without notice.  
Customers should verify actual device performance in their specific applications.

# Switching Chip Diode Series - 0805 / 1206

**BOURNS®**

## Rating and Characteristic Curves: CDxxx-S01575

### Forward Characteristics

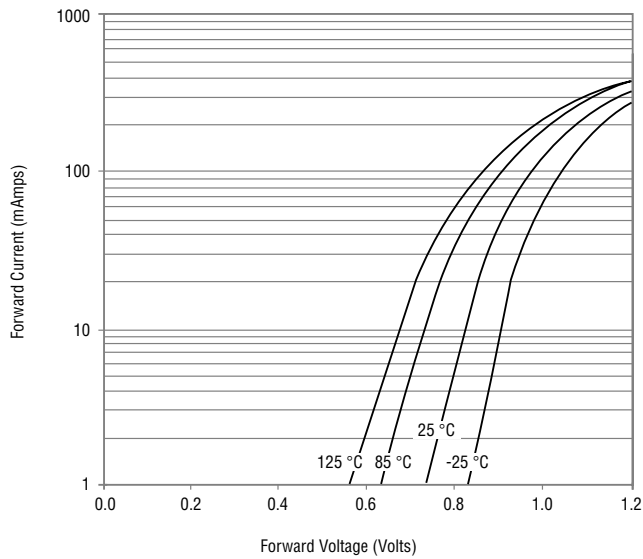

### Reverse Characteristics

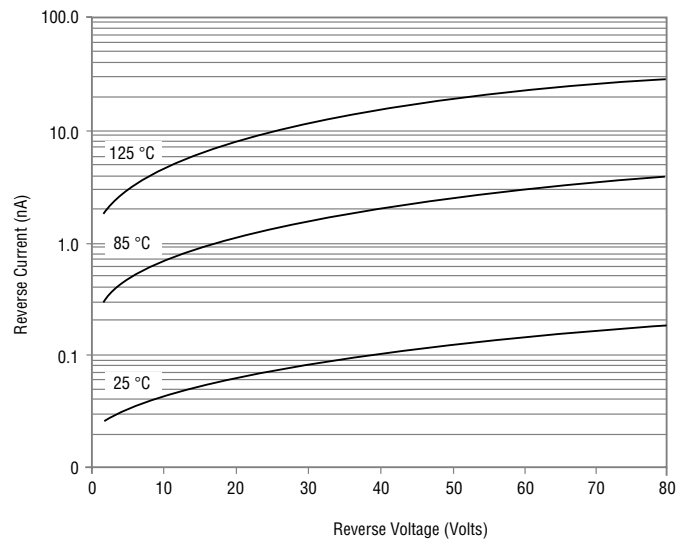

### Derating Curve

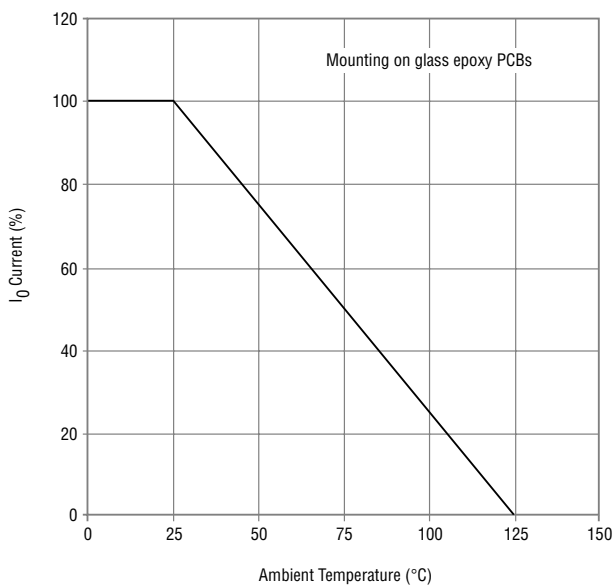

### Capacitance Between Terminals

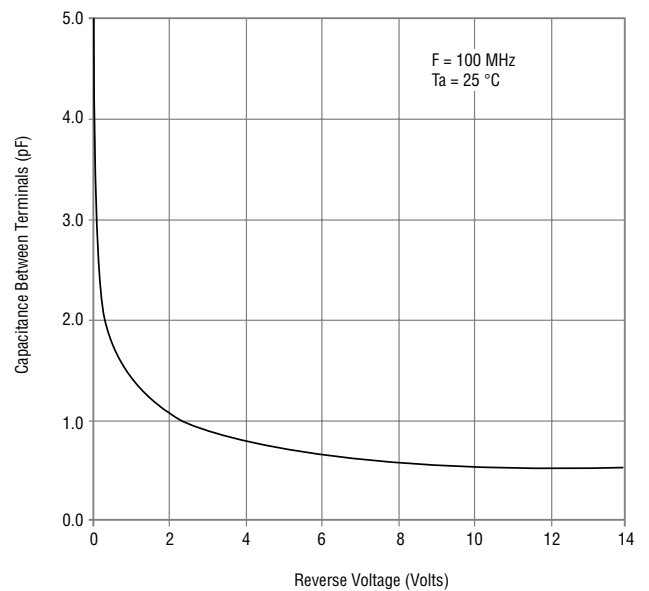

Specifications are subject to change without notice. Customers should verify actual device performance in their specific applications.

# Switching Chip Diode Series - 0805 / 1206

**BOURNS®**

## Rating and Characteristic Curves: CDxxxx-S0180R

### Forward Characteristics

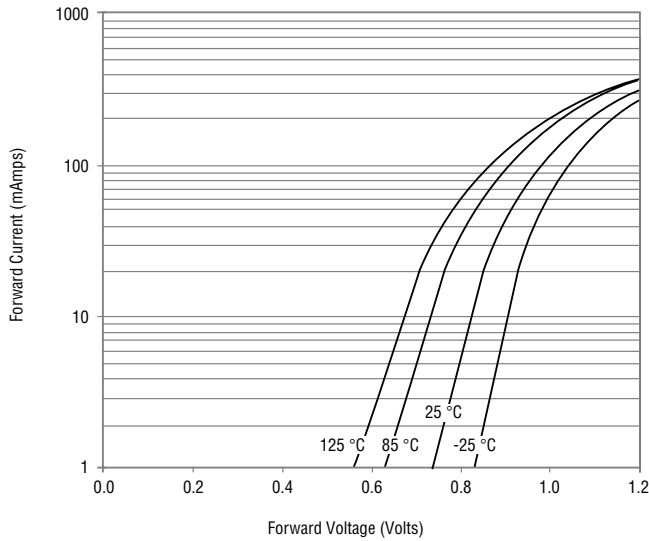

### Reverse Characteristics

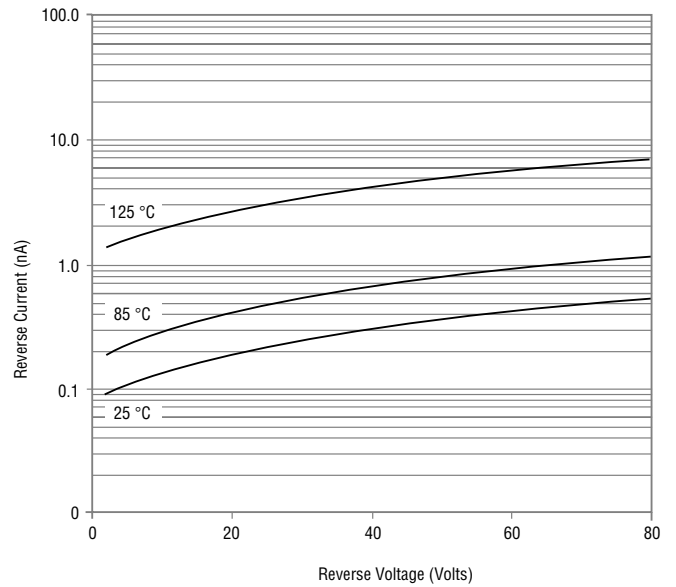

### Derating Curve

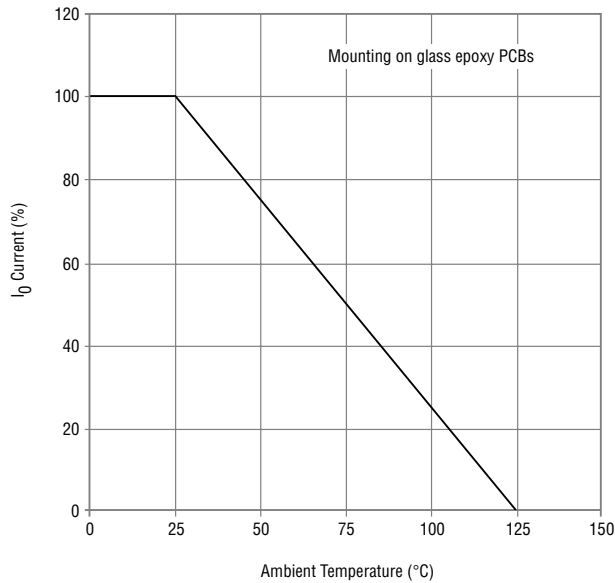

### Capacitance Between Terminals

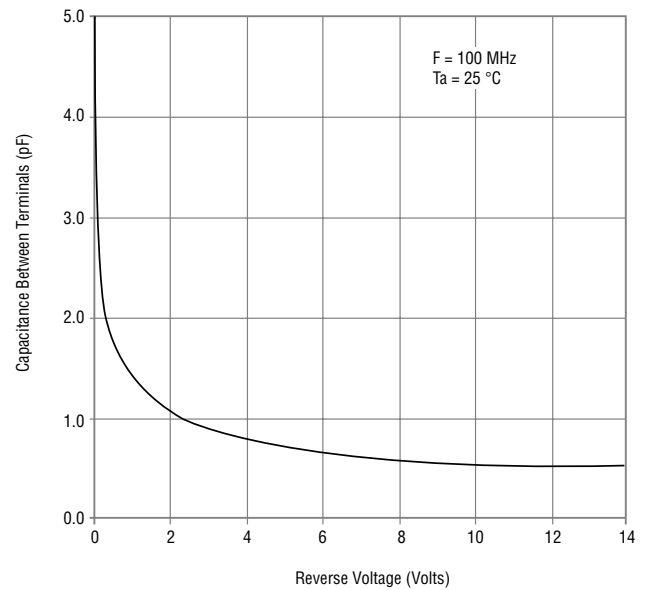

Specifications are subject to change without notice.  
Customers should verify actual device performance in their specific applications.

# Switching Chip Diode Series - 0805 / 1206

**BOURNS®**

## Packaging Information

The product will be dispensed in Tape and Reel format (see diagram below).

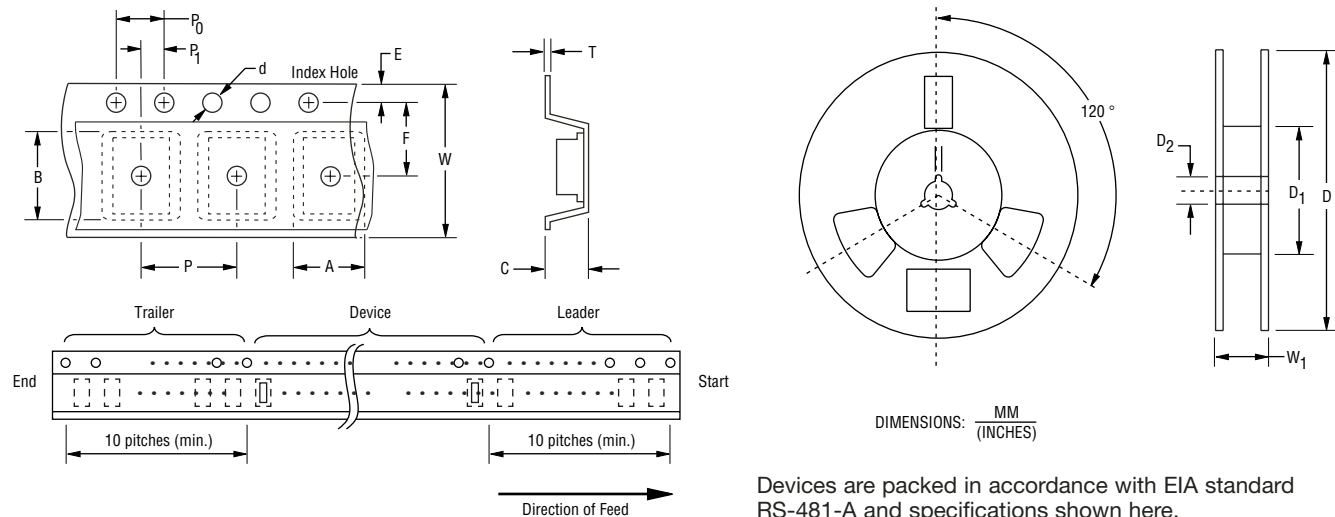

Item	Symbol	0805	1206
Carrier Width	A	$\frac{1.55 \pm 0.10}{(0.061 - 0.004)}$	$\frac{1.70 \pm 0.10}{(0.067 - 0.004)}$
Carrier Length	B	$\frac{2.30 \pm 0.10}{(0.091 - 0.004)}$	$\frac{3.40 \pm 0.10}{(0.134 - 0.004)}$
Carrier Depth	C	$\frac{1.25 \pm 0.10}{(0.049 - 0.004)}$	$\frac{1.25 \pm 0.10}{(0.049 - 0.004)}$
Sprocket Hole	d	$\frac{1.55 \pm 0.05}{(0.061 - 0.002)}$	$\frac{1.55 \pm 0.10}{(0.061 - 0.004)}$
Reel Outside Diameter	D	$\frac{178}{(7.008)}$	$\frac{178}{(7.008)}$
Reel Inner Diameter	D <sub>1</sub>	$\frac{60.0}{(2.362)}$ MIN.	$\frac{60.0}{(2.362)}$ MIN.
Feed Hole Diameter	D <sub>2</sub>	$\frac{13.0 \pm 0.20}{(0.512 - 0.008)}$	$\frac{13.0 \pm 0.20}{(0.512 - 0.008)}$
Sprocket Hole Position	E	$\frac{1.75 \pm 0.10}{(0.069 - 0.004)}$	$\frac{1.75 \pm 0.10}{(0.069 - 0.004)}$
Punch Hole Position	F	$\frac{3.50 \pm 0.05}{(0.138 - 0.002)}$	$\frac{3.50 \pm 0.05}{(0.138 - 0.002)}$
Punch Hole Pitch	P	$\frac{4.00 \pm 0.10}{(0.157 - 0.004)}$	$\frac{4.00 \pm 0.10}{(0.157 - 0.004)}$
Sprocket Hole Pitch	P <sub>0</sub>	$\frac{4.00 \pm 0.10}{(0.157 - 0.004)}$	$\frac{4.00 \pm 0.10}{(0.157 - 0.004)}$
Embossment Center	P <sub>1</sub>	$\frac{2.00 \pm 0.05}{(0.079 - 0.002)}$	$\frac{2.00 \pm 0.05}{(0.079 - 0.002)}$
Overall Tape Thickness	T	$\frac{0.25 \pm 0.05}{(0.010 - 0.002)}$	$\frac{0.20 \pm 0.05}{(0.008 - 0.002)}$
Tape Width	W	$\frac{8.00 \pm 0.20}{(0.315 - 0.008)}$	$\frac{8.00 \pm 0.20}{(0.315 - 0.008)}$
Reel Width	W <sub>1</sub>	$\frac{13.5}{(0.531)}$ MAX.	$\frac{13.5}{(0.531)}$ MAX.
Quantity per Reel	--	3,000	3,000