



CTA/CTB08

8Amp - 400/600/800/1000V - TRIAC

Applications

- Phase Control
- Static Switching
- Light Dimming
- Motor Speed Control
- Kitchen Equipment
- Power Tools
- Solenoid Valve Controls:
 - Dishwashers
 - Washing Machines

- > Suitable for General Purpose AC Switching
- > Alternistor/No Snubber Versions for Inductive Loads
- > Logic Level Available for use with Microcontrollers and Low Level Devices
- > IGT Range 5-50 mA (Q1)
- > V_{DRM}/V_{RMM} 400, 600, 800, 1000V

Absolute Maximum Ratings

	CONDITIONS	SYMBOL	RATING
RMS On-State Current (full sine wave)	T _c = 110°C T _c = 100°C	T0-220AB T0-220AB Iso	I _{T(RMS)} 8A
Non Repetitive Surge Peak On-State Current (Full Cycle, T _j Initial = 25°C)	F = 50 Hz F = 60 Hz		I _{TSM} 80A 84A
I ² t Value for fusing	tp = 10 ms		I ² t 36A ² s
Critical rate of rise of on-state current I _G = 2 x I _{GT} , tr < 100 ns, T _j = 125°C			di/dt 100A/μs
Peak Gate Current @ T _j = 125°C	tp = 20 μs		I _{GM} 4A
Average Gate Power Dissipation @ T _j = 125°C			P _{G(AV)} 1W
Storage Temperature Range			T _{stg} -40 to +150°C
Operating Junction Temperature Range			T _j -40 to +125°C
Isolation Voltage (CTA Series only)			V _{ISO} 2500 V _{RMS}

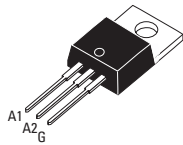

TO-220AB Isolated (CTA08)

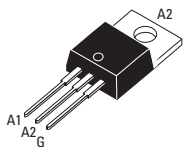

TO-220AB Non-Isolated (CTB08)



Electrical Characteristics

ALTERNISTOR/NO SNUBBER AND LOGIC LEVEL (3 Quadrants)	TW	SW	CW	BW	
I _{GT} MAX @ V _D = 12 V, R _L = 30Ω NOTE 1	QI-II-III	5mA	10mA	35mA	50mA
V _{GT} MAX @ V _D = 12 V, R _L = 30Ω	QI-II-III	1.3V	1.3V	1.3V	1.3V
V _{GD} MIN @ V _D = V _{DRM} , R _L = 3.3kΩ	T _j = 125°C QI-II-III	0.2V	0.2V	0.2V	0.2V
I _H MAX @ I _T = 500 mA NOTE 2		10mA	15mA	35mA	50mA
I _L MAX @ I _G = 1.2 I _{GT}	QI-III	10mA	25mA	50mA	70mA
I _L MAX @ I _G = 1.2 I _{GT}	Q-II	15mA	30mA	60mA	80mA
dv/dt MIN @ V _D = 67%V _{DRM} (gate open) NOTE 2	T _j = 125°C	20V/μs	40V/μs	400V/μs	1000V/μs
(di/dt) _c MIN @ (dv/dt) _c = 0.1 V/ms NOTE 2	T _j = 125°C	3.5A/ms	5.4A/ms		
(di/dt) _c MIN @ (dv/dt) _c = 10 V/ms NOTE 2	T _j = 125°C	1.5A/ms	2.8A/ms		
(di/dt) _c MIN without Snubber NOTE 2	T _j = 125°C			4.5A/ms	7A/ms

STANDARD (4 Quadrants)	C	B	
I _{GT} MAX @ V _D = 12 V, R _L = 30Ω NOTE 1	QI-II-III	25mA	50mA
I _{GT} MAX @ V _D = 12 V, R _L = 30Ω NOTE 1	QIV	50mA	100mA
V _{GT} MAX @ V _D = 12 V, R _L = 30Ω	Q-All		1.3V
V _{GD} MIN @ V _D = V _{DRM} , R _L = 3.3kΩ	T _j = 125°C Q-All		0.2V
I _H MAX @ I _T = 500 mA NOTE 2		25mA	50mA
I _L MAX @ I _G = 1.2 I _{GT}	QI-III-IV	40mA	50mA
I _L MAX @ I _G = 1.2 I _{GT}	Q-II	80mA	100mA
dv/dt MIN @ V _D = 67%V _{DRM} (gate open) NOTE 2	T _j = 125°C	200V/μs	400V/μs
(dv/dt) _c MIN @ (di/dt) _c = 3.5 A/ms NOTE 2	T _j = 125°C	5V/μs	10V/μs

GENERAL NOTES

1. Minimum IGT is guaranteed at 5% of IGT max.
2. For both polarities of A2 referenced to A1
3. All parameters at 25 degrees C unless otherwise specified.

ISO9001 Certified

Static Characteristics

V_T MAX @ $I_{TM} = 11$ A, $t_p = 380\mu s$ NOTE 2	$T_j = 25^\circ C$	1.55V
V_{TO} MAX @ Threshold Voltage NOTE 2	$T_j = 125^\circ C$	0.85V
R_d MAX @ Dynamic Resistance NOTE 2	$T_j = 125^\circ C$	50mΩ
I_{DRM} MAX @ $V_{DRM} = V_{RRM}$	$T_j = 25^\circ C$	5μA
I_{RRM} MAX @ $V_{DRM} = V_{RRM}$	$T_j = 125^\circ C$	1mA

Thermal Resistances

	SYMBOL	RATING
Junction to Case (AC)	TO-220AB $R_{th(j-c)}$	1.6°C/W
Junction to Case (AC)	TO-220AB Isolated $R_{th(j-c)}$	2.5°C/W
Junction to Ambient	TO-220AB $R_{th(j-a)}$	60°C/W
Junction to Ambient	TO-220AB Isolated $R_{th(j-a)}$	60°C/W

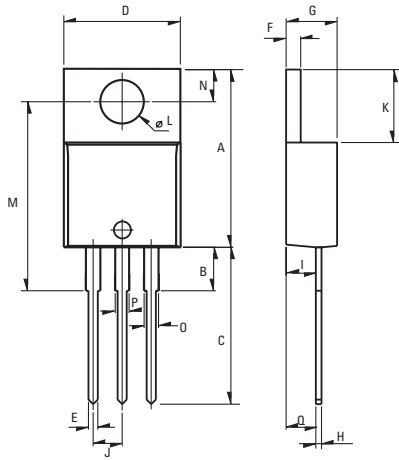

Weight: 2.3g (0.08 oz)

Dimensions

REF.	Millimeters			Inches		
	Min.	Typ.	Max.	Min.	Typ.	Max.
A	15.24		15.75	0.6		0.62
B		3.23			0.127	
C	12.78		13.79	0.503		0.543
D	9.96		10.36	0.392		0.408
E	0.69		0.94	0.027		0.037
F	1.22		1.32	0.048		0.052
G	4.62		4.83	0.182		0.19
H	0.46		0.61	0.018		0.024
I	2.49		2.84	0.098		0.112
J	2.39		2.69	0.094		0.106
K	6.48		6.88	0.255		0.271
L	3.78		3.89	0.149		0.153
M	15.49	16	16.51	0.61	0.63	0.65
N	2.59		2.9	0.102		0.114
O	0.99		1.55	0.039		0.061
P	0.99		1.55	0.039		0.061
Q		2.67			0.105	

Part Number Selection

Part Number	Voltage [Vpk]	I_{GT} [mA]	Type	Package
CTA/CTB08-xxxB	400, 600, 800, 1000	50mA	Standard	TO-220AB
CTA/CTB08-xxxBW	400, 600, 800, 1000	50mA	Alternistor/No Snubber	TO-220AB
CTA/CTB08-xxxC	400, 600, 800, 1000	25mA	Standard	TO-220AB
CTA/CTB08-xxxCW	400, 600, 800, 1000	35mA	Alternistor/No Snubber	TO-220AB
CTA/CTB08-xxxSW	400, 600, 800, 1000	10mA	Logic Level	TO-220AB
CTA/CTB08-xxxTW	400, 600, 800	5mA	Logic Level	TO-220AB

Part Number Designation

SERIES
CT **B** **08** - **800** **CW** **PT**

Rated Current
08: 8 Amp

Type
B: Standard ($I_{GT}=50$ mA)
BW: Alternistor/No Snubber ($I_{GT}=50$ mA)
C: Standard ($I_{GT}=25$ mA)
CW: Alternistor/No Snubber ($I_{GT}=35$ mA)
SW: Logic Level ($I_{GT}=10$ mA)
TW: Logic Level ($I_{GT}=5$ mA)

Isolation Type
A: Isolated
B: Non-Isolated

Maximum Blocking Voltage
400: 400Vpk
600: 600Vpk
800: 800Vpk
1000: 1000Vpk

Packaging
Blank: Bulk
PT: Plastic Tube

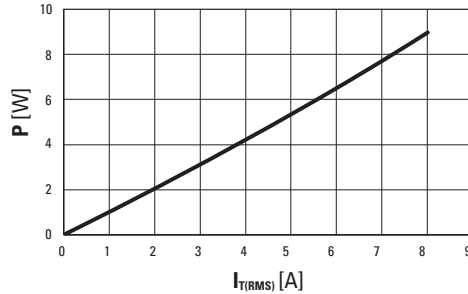

Fig. 1: Power dissipation versus RMS on-state current (full cycle).

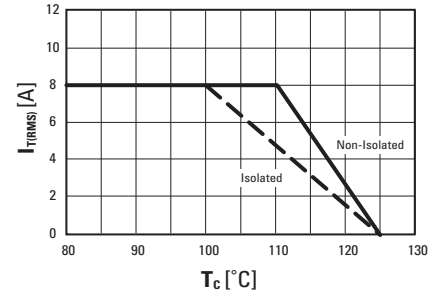

Fig. 2: RMS on-state current versus case temperature (full cycle)

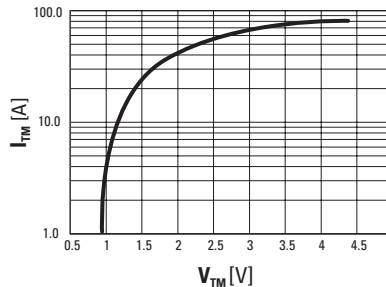

Fig. 3: On-state current versus on-state voltage (instantaneous values)

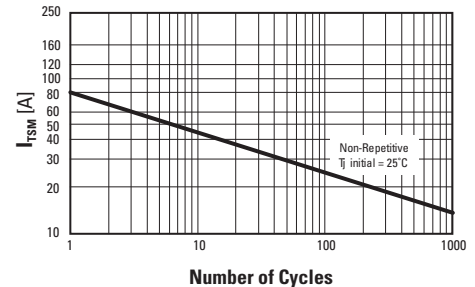

Fig. 4: Non-repetitive surge peak on-state current versus number of cycles.

ISO9001 Certified

Approvals

UL Recognized Component - E72445

(For CTA series)

USA

Sales Support (877) 502-5500

Tech Support (877) 702-7700

Fax (619) 710-8540

Email: sales@crydom.com

Crydom Corp

2320 Paseo de las Americas, Suite 201

San Diego, CA 92154

EUROPE - UK

Telephone +44 (0) 1202 365070

Fax +44 (0) 1202 365090

Email: intsales@crydom.com

Crydom International Ltd.

7 Cobham Road

Ferndown Industrial Estate

Wimborne, Dorset BH21 7PE

Germany

Telephone +49 (0) 180 3000 506

ASIA - Thailand

Telephone +66 (0)2 665 2517

Fax +66 (0)2 665 2588

Crydom Asia

18/8 Fico Place 12th Floor

Soi Sukhumvit 21 (Asoke)

Klongtoey Nua, Wattana

Bangkok, Thailand 10110