

High Voltage, High speed IGBT

Short Circuit SOA Capability

IXSH 35N140A

V_{CES}	I_{C25}	$V_{CE(sat)}$
1400 V	70 A	4 V

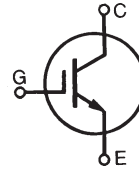

Symbol	Test Conditions	Maximum Ratings	
V_{CES}	$T_J = 25^\circ\text{C}$ to 150°C	1400	V
V_{CGR}	$T_J = 25^\circ\text{C}$ to 150°C ; $R_{GE} = 1\text{ MW}$	1400	V
V_{GES}	Continuous	± 20	V
V_{GEM}	Transient	± 30	V
I_{C25}	$T_C = 25^\circ\text{C}$	70	A
I_{C90}	$T_C = 90^\circ\text{C}$	35	A
I_{CM}	$T_C = 25^\circ\text{C}$, 1 ms	140	A
SSOA (RBSOA)	$V_{GE} = 15\text{ V}$, $T_J = 125^\circ\text{C}$, $R_G = 22\ \Omega$ Clamped inductive load	$I_{CM} = 70$ @ 960	A V
t_{SC} (SCSOA)	$V_{GE} = 15\text{ V}$, $V_{CE} = 840\text{ V}$, $T_J = 125^\circ\text{C}$ $R_G = 22\text{ W}$, non repetitive	10	μs
P_C	$T_C = 25^\circ\text{C}$	300	W
T_J		-55 ... +150	$^\circ\text{C}$
T_{JM}		150	$^\circ\text{C}$
T_{stg}		-55 ... +150	$^\circ\text{C}$
M_d	Mounting torque	1.13/10	Nm/lb.in.
Weight		6	g
Maximum lead temperature for soldering 1.6 mm (0.062 in.) from case for 10 s		300	$^\circ\text{C}$

TO-247 AD

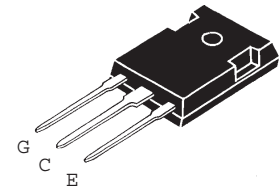

G = Gate, C = Collector,
E = Emitter, TAB = Collector

Features

- International standard package JEDECTO-247
- High frequency IGBT with guaranteed Short Circuit SOA capability
- Fast Fall Time for switching speeds up to 20 kHz
- 2nd generation HDMOS™ process
- Low $V_{CE(sat)}$
 - for minimum on-state conduction losses
- MOS Gate turn-on
 - drive simplicity

Applications

- AC motor speed control
- DC servo and robot drive
- Uninterruptible power supplies (UPS)
- Switch-mode and resonant-mode power supplies
- Welding

Advantages

- Easy to mount with 1 screw (isolated mounting screw hole)
- High power density

Symbol	Test Conditions	Characteristic Values ($T_J = 25^\circ\text{C}$, unless otherwise specified)		
		min.	typ.	max.
$V_{GE(th)}$	$I_C = 4\text{ mA}$, $V_{CE} = V_{GE}$	4.5		6.5 V
I_{CES}	$V_{CE} = 1400\text{ V}$ $V_{GE} = 0\text{ V}$			50 μA 2 mA
I_{GES}	$V_{CE} = 0\text{ V}$, $V_{GE} = \pm 20\text{ V}$			$\pm 100\text{ nA}$
$V_{CE(sat)}$	$I_C = I_{C90}$, $V_{GE} = 15\text{ V}$	3.4	4	V

Symbol	Test Conditions	Characteristic Values ($T_J = 25^\circ\text{C}$, unless otherwise specified)			
		min.	typ.	max.	
g_{fs}	$I_C = I_{C90}; V_{CE} = 10\text{ V}$, Pulse test, $t \leq 300\ \mu\text{s}$, duty cycle $d \leq 2\%$	16	23	S	
C_{ies}	$V_{CE} = 25\text{ V}, V_{GE} = 0\text{ V}, f = 1\text{ MHz}$		3000	pF	
C_{oes}			235	pF	
C_{res}			60	pF	
Q_g	$I_C = I_{C90}, V_{GE} = 15\text{ V}, V_{CE} = 0.5 V_{CES}$		120	nC	
Q_{ge}			32	nC	
Q_{gc}			50	nC	
$t_{d(on)}$	Inductive load, $T_J = 25^\circ\text{C}$ $I_C = I_{C90}, V_{GE} = 15\text{ V}$ $V_{CE} = 960\text{ V}, R_G = 3.0\ \Omega$		40	ns	
t_{ri}			60	ns	
$t_{d(off)}$			150	300 ns	
t_{fi}			200	450 ns	
E_{off}			4.0	mJ	
$t_{d(on)}$	Inductive load, $T_J = 125^\circ\text{C}$ $I_C = I_{C90}, V_{GE} = 15\text{ V}$ $V_{CE} = 960\text{ V}, R_G = 3.0\ \Omega$		40	ns	
t_{ri}			65	ns	
E_{on}			4	mJ	
$t_{d(off)}$			240	ns	
t_{fi}			400	ns	
E_{off}	9.5	mJ			
R_{thJC}				0.42	K/W
R_{thCK}			0.25		K/W

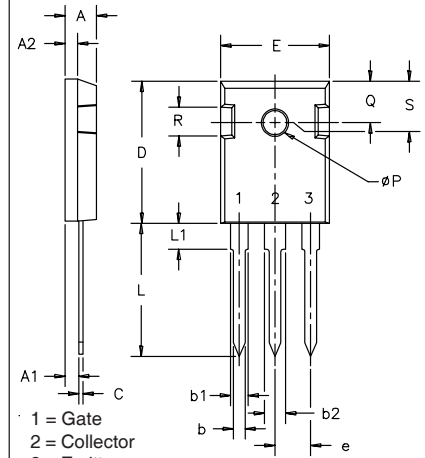
TO-247 AD Outline

SYM	INCHES		MILLIMETERS	
	MIN	MAX	MIN	MAX
A	.185	.209	4.7	5.3
A1	.087	.102	2.2	2.54
A2	.059	.098	2.2	2.6
b	.040	.055	1.0	1.4
b1	.065	.084	1.65	2.13
b2	.113	.123	2.87	3.12
C	.016	.031	.4	.8
D	.819	.845	20.80	21.46
E	.610	.640	15.75	16.26
e	.215 BSC		5.45 BSC	
L	.780	.800	19.81	20.32
L1		.177		4.50
ϕP	.140	.144	3.55	3.65
Q	.212	.244	5.4	6.2
R	.170	.216	4.32	5.49
S	.242 BSC		6.15 BSC	

IXYS reserves the right to change limits, test conditions, and dimensions.

IXYS MOSFETs and IGBTs are covered by one or more of the following U.S. patents:

 4,835,592 4,881,106 5,017,508 5,049,961 5,187,117 5,486,715 6,306,728B1 6,259,123B1 6,306,728B1
 4,850,072 4,931,844 5,034,796 5,063,307 5,237,481 5,381,025 6,404,065B1 6,162,665 6,534,343

Fig. 1. Output Characteristics @ 25 Deg. C

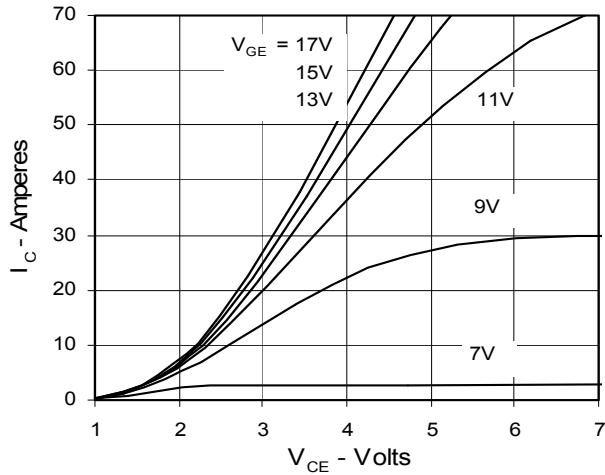

Fig. 2. Extended Output Characteristics @ 25 deg. C

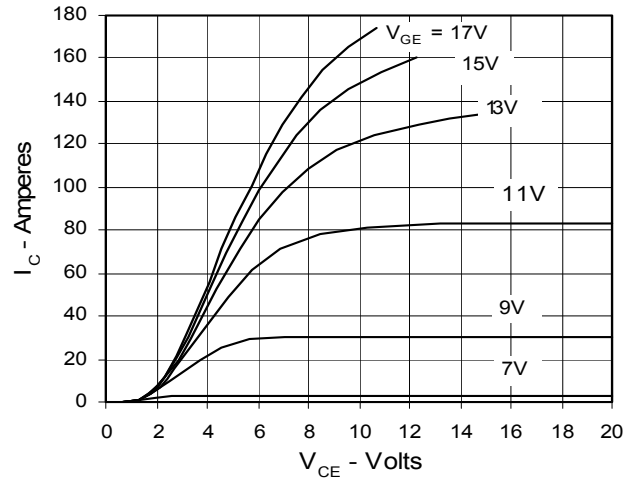

Fig. 3. Output Characteristics @ 125 Deg. C

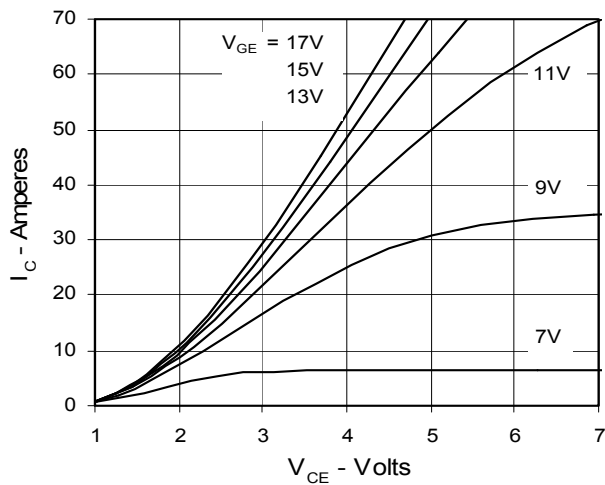

Fig. 4. Temperature Dependence of $V_{CE(sat)}$

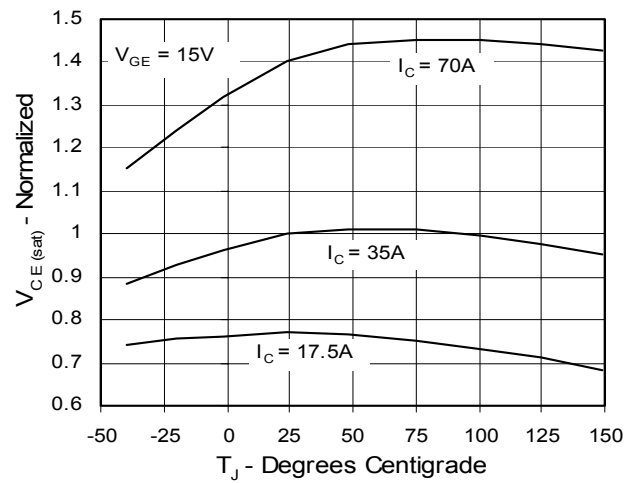

Fig. 5. Collector-to-Emitter Voltage vs. Gate-to-Emitter voltage

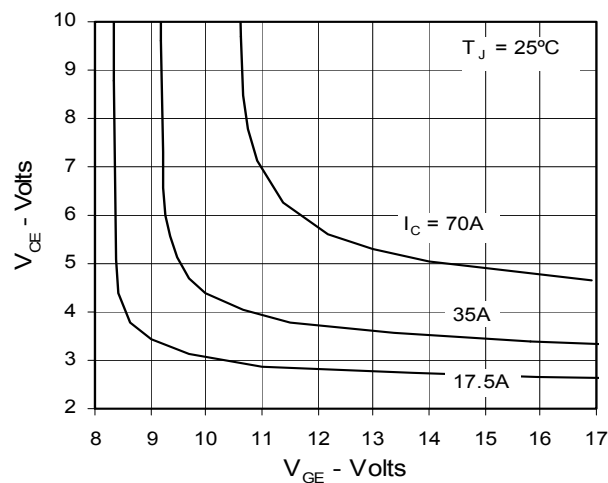

Fig. 6. Input Admittance

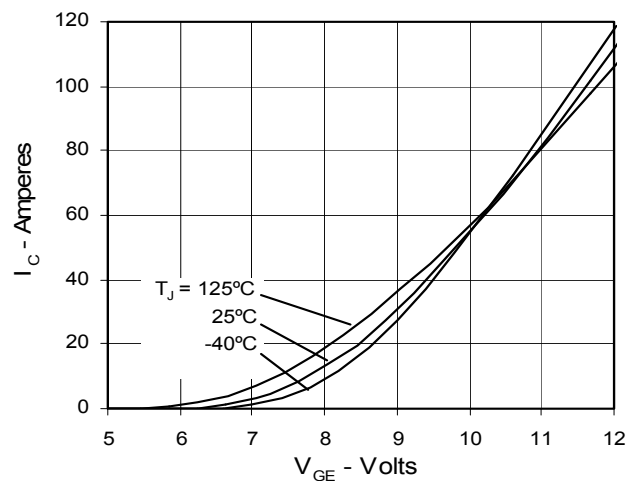

Fig. 7. Transconductance

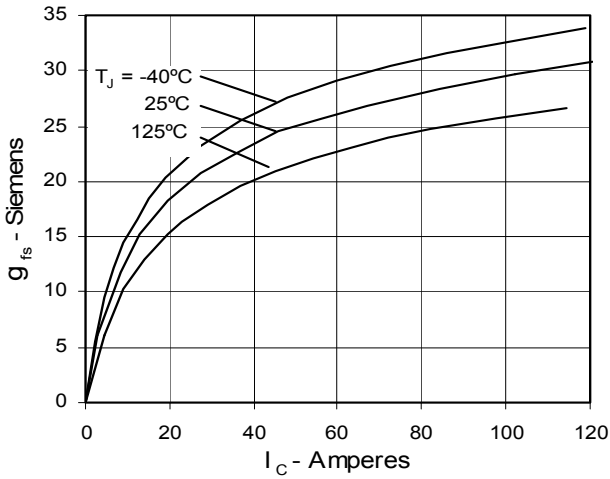

Fig. 8. Dependence of E_{off} on R_G

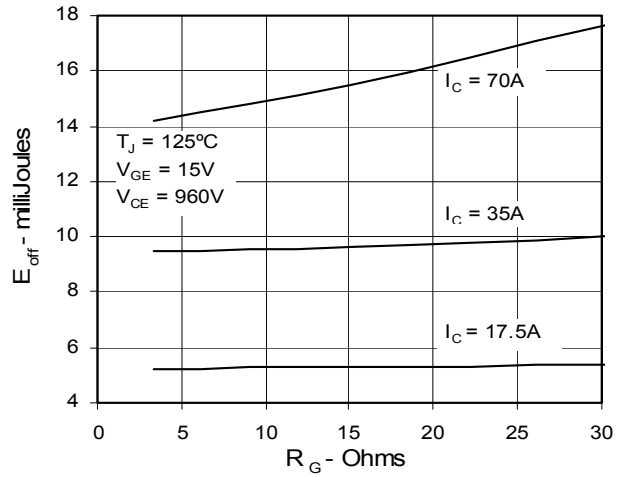

Fig. 9. Dependence of E_{off} on I_C

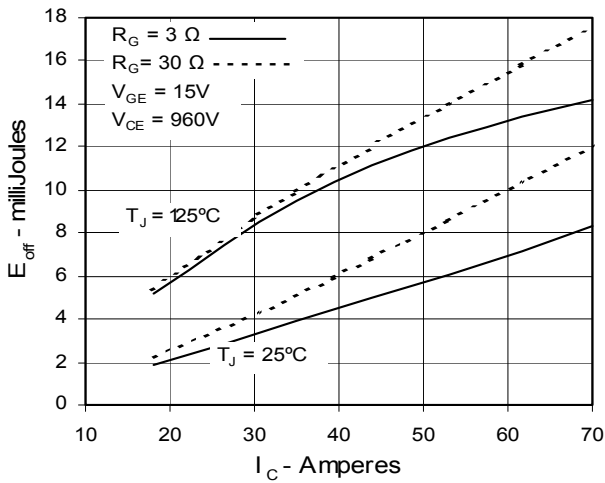

Fig. 10. Dependence of E_{off} on Temperature

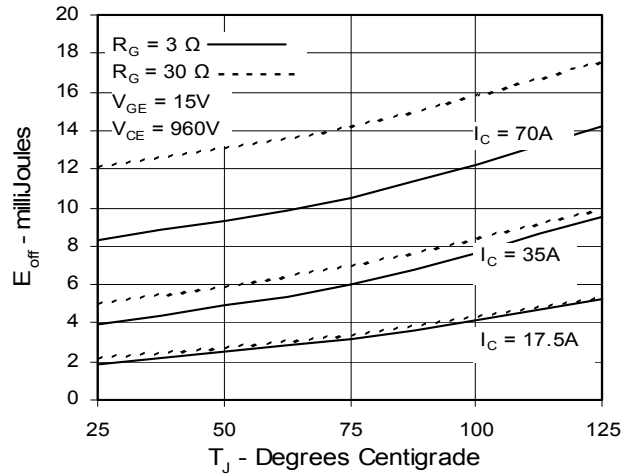

Fig. 11. Gate Charge

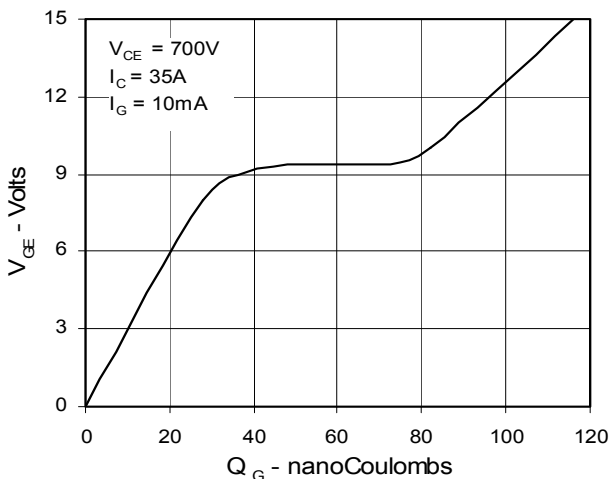
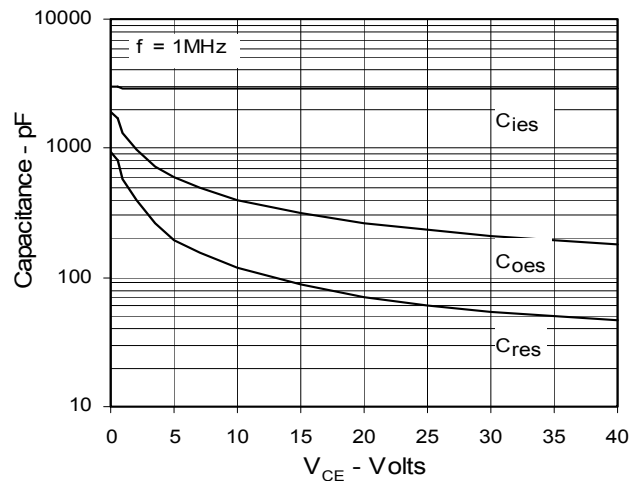

Fig. 12. Capacitance



IXYS reserves the right to change limits, test conditions, and dimensions.

IXYS MOSFETs and IGBTs are covered by one or more of the following U.S. patents:

4,835,592 4,881,106 5,017,508 5,049,961 5,187,117 5,486,715 6,306,728B1 6,259,123B1 6,306,728B1
4,850,072 4,931,844 5,034,796 5,063,307 5,237,481 5,381,025 6,404,065B1 6,162,665 6,534,343

Fig. 13. Maximum Transient Thermal Resistance

