

Powerex, Inc., 200 Hillis Street, Youngwood, Pennsylvania 15697-1800 (412) 925-7272
Powerex, Europe, S.A. 428 Avenue G. Durand, BP107, 72003 Le Mans, France (43) 41.14.14

Phase Control SCR
1200 Amperes Average
2400 Volts

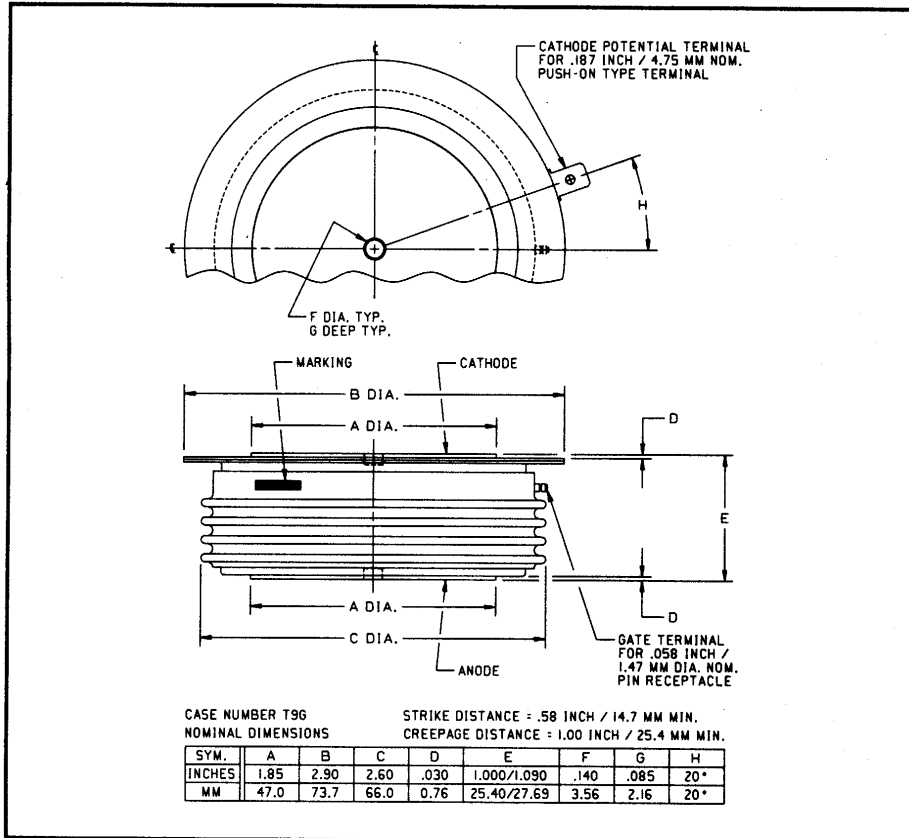

T9G0 1200A (Outline Drawing)

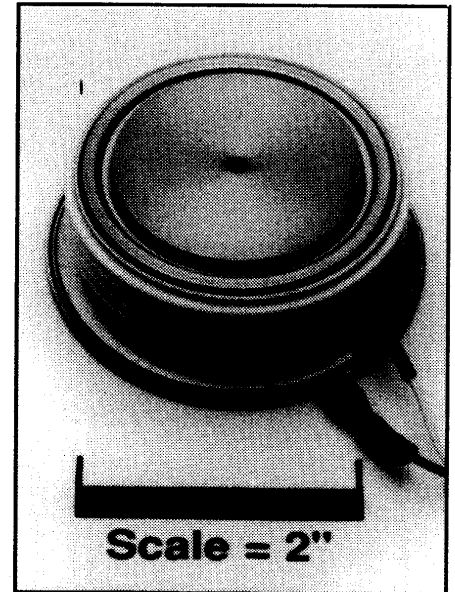

T9G0 1200A Phase Control SCR
1200 Amperes Average, 2400 Volts

Description:

Powerex Silicon Controlled Rectifiers (SCR) are designed for phase control applications. These are all-diffused, Press-Pak, hermetic Pow-R-Disc devices employing the field proven amplifying gate.

Features:

- Low On-State Voltage
- High di/dt Capability
- High dv/dt Capability
- Hermetic Packaging
- Excellent Surge and I^2t Ratings

Applications:

- Power Supplies
- Motor Control

Ordering Information:

Select the complete 12 digit part number you desire from the table below.

Type	Voltage	Current	Turn-off	Gate Current	Lead Code
	V_{DRM}/V_{RRM} (Volts)	$I_T(av)$ (A)	t_q (μ sec)	I_{GT} (mA)	
T9G0	02 through 24	12	0	3	DH
	200V through 2400V	1200A	350 μ sec (Typical)	200mA	12"

Powerex, Inc., 200 Hillis Street, Youngwood, Pennsylvania 15697-1800 (412) 925-7272
Powerex, Europe, S.A. 428 Avenue G. Durand, BP107, 72003 Le Mans, France (43) 41.14.14

T9G0 1200A
Phase Control SCR
1200 Amperes Average, 2400 Volts

Absolute Maximum Ratings

Characteristics	Symbol	T9G0 1200A	Units
Non-repetitive Transient Peak Reverse Voltage	V_{RSM}	$V_{RRM} + 100V$	Volts
RMS On-state Current, $T_C = 85^\circ C$	$I_{T(rms)}$	1880	Amperes
Average Current 180° Sine Wave, $T_C = 85^\circ C$	$I_{T(av)}$	1200	Amperes
RMS On-state Current, $T_C = 55^\circ C$	$I_{T(rms)}$	2790	Amperes
Average Current 180° Sine Wave, $T_C = 55^\circ C$	$I_{T(av)}$	1780	Amperes
Peak One Cycle Surge On-state Current (Non-repetitive) 60Hz	I_{tsm}	27000	Amperes
Peak One Cycle Surge On-state Current (Non-repetitive) 50Hz	I_{tsm}	24650	Amperes
Critical Rate-of-rise of On-state Current (Non-repetitive)	di/dt	300	A/ μ sec
Critical Rate-of-rise of On-state Current (Repetitive)	di/dt	150	A/ μ sec
I^2t (for Fusing) for One Cycle, 60Hz	I^2t	3,040,000	A ² sec
Peak Gate Power Dissipation	P_{GM}	16	Watts
Average Gate Power Dissipation	$P_{G(av)}$	3	Watts
Operating Temperature	T_j	-40 to +125°C	°C
Storage Temperature	T_{stg}	-40 to +150°C	°C
Approximate Weight		1	lb.
		454	g
Mounting Force		5000 to 5500	lb.
		2270 to 2500	kg.

T9G0 1200A

Phase Control SCR

1200 Amperes Average, 2400 Volts

Electrical Characteristics, $T_j = 25^\circ\text{C}$ Unless Otherwise Specified

Characteristics	Symbol	Test Conditions	Min.	Typ.	Max.	Units
Repetitive Peak Reverse Leakage Current	I_{RRM}	$T_j = 125^\circ\text{C}, V_R = V_{RRM}$			75	mA
Repetitive Peak Forward Leakage Current	I_{DRM}	$T_j = 125^\circ\text{C}, V_D = V_{DRM}$			75	mA
Peak On-state Voltage	V_{TM}	$I_{TM} = 1500\text{A Peak}$ Duty Cycle < 0.1%			1.35	Volts
Threshold Voltage, Low-level	$V_{(TO)1}$	$T_j = 125^\circ\text{C}, I = 15\%, I_{T(av)} \text{ to } \pi I_{T(av)}$			0.60559	Volts
Slope Resistance, Low-level	r_{T1}				0.2681	m Ω
Threshold Voltage, High-level	$V_{(TO)2}$	$T_j = 125^\circ\text{C}, I = \pi I_{T(av)} \text{ to } I_{TSM}$			0.64284	Volts
Slope Resistance, High-level	r_{T2}				0.1906	m Ω
V_{TM} Coefficients, Low-level		$T_j = 125^\circ\text{C}, I = 15\% I_{T(av)} \text{ to } \pi I_{T(av)}$				$A_1 = -0.55126$ $B_1 = 0.21303$ $C_1 = 1.433\text{E-}04$ $D_1 = -0.003097$
V_{TM} Coefficients, High-level		$T_j = 125^\circ\text{C}, I = \pi I_{T(av)} \text{ to } I_{TSM}$				$A_1 = -62.5287$ $B_1 = 10.457$ $C_1 = 0.001238$ $D_1 = -0.43650$
Typical Turn-on Time	t_{on}	$I_{TM} = 1000\text{A}, V_D = 450\text{V}$		3		μsec
Typical Turn-off Time	t_q	$T_j = 125^\circ\text{C}, I_T = 250\text{A},$ $di_R/dt = 50\text{A}/\mu\text{sec Reapplied}$ $dv/dt = 20\text{V}/\mu\text{sec Linear to}$ $80\% V_{DRM}$		350		μsec
Minimum Critical dv/dt - Exponential to $V_{DRN=M}$	dv/dt	$T_j = 125^\circ\text{C}$	300			V/ μsec
Gate Trigger Current	I_{GT}	$T_j = 25^\circ\text{C}, V_D = 12\text{V}$			200	mA
Gate Trigger Voltage	V_{GT}	$T_j = 25^\circ\text{C}, V_D = 12\text{V}$			3.0	Volts
Non-Triggering Gate Voltage	V_{GDM}	$T_j = 125^\circ\text{C}, V_D = V_{DRM}$			0.15	Volts
Peak Forward Gate Current	I_{GTM}				4	A
Peak Reverse Gate Voltage	V_{GRM}				5	Volts

Thermal Characteristics

Maximum Thermal Resistance, Double Sided Cooling

Junction-to-Case	$R_{\theta(j-c)}$		0.023	$^\circ\text{C/W}$
Case-to-Sink	$R_{\theta(c-s)}$		0.0075	$^\circ\text{C/W}$

Powerex, Inc., 200 Hillis Street, Youngwood, Pennsylvania 15697-1800 (412) 925-7272
 Powerex, Europe, S.A. 428 Avenue G. Durand, BP107, 72003 Le Mans, France (43) 41.14.14

T9G0 1200A
Phase Control SCR
 1200 Amperes Average, 2400 Volts

Maximum On-State Forward Voltage Drop
 (T_J = 125 °C)

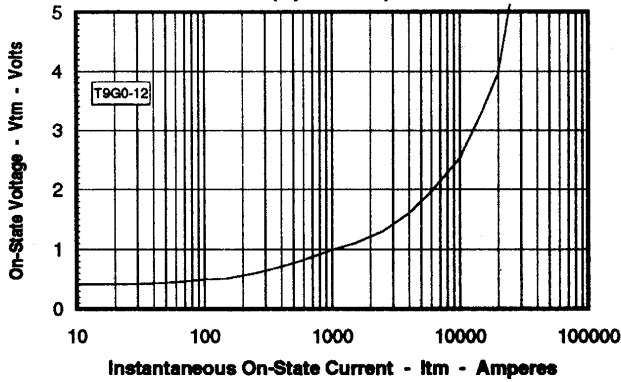

Maximum Transient Thermal Impedance
 (Junction to Case)

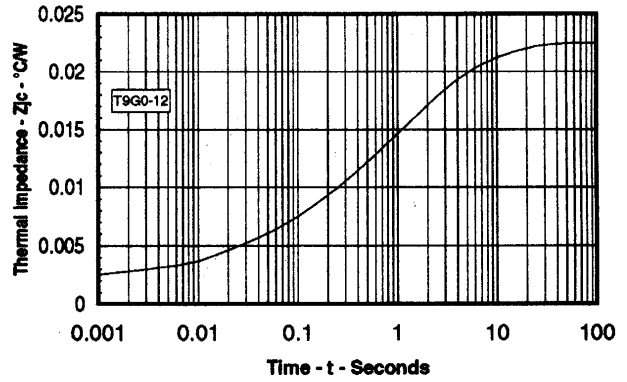

Maximum On-State Power Dissipation
 (Sinusoidal Waveform)

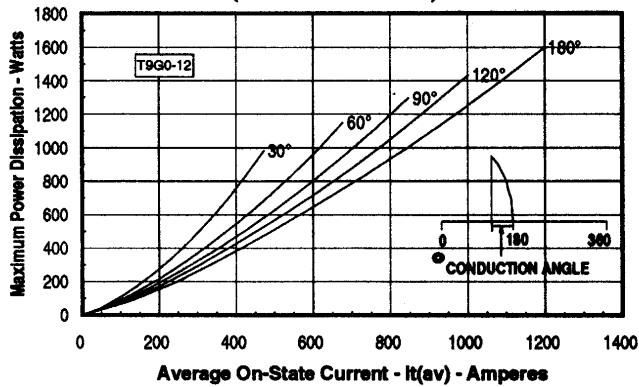

Maximum Allowable Case Temperature
 (Sinusoidal Waveform)

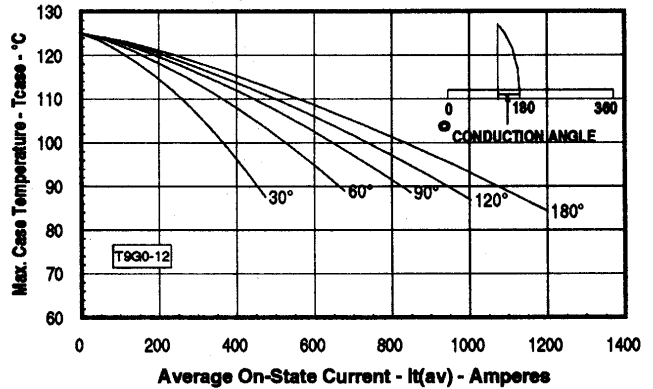

Maximum On-State Power Dissipation
 (Rectangular Waveform)

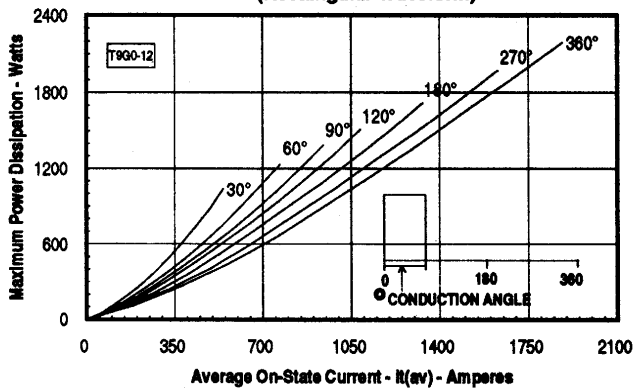

Maximum Allowable Case Temperature
 (Rectangular Waveform)

