

DATA SHEET

Surface Mount Mixer and Detector Schottky Diodes

Features

- Designed for high-volume commercial applications
- Available lead (Pb)-free and RoHS-compliant MSL-1 @ 260 °C⁽¹⁾ per JEDEC J-STD-020
- Tight parameter distribution
- Available as singles, pairs and dual pairs
- Available in tape and reel packaging

Description

These low-cost, surface mountable, plastic packaged, silicon mixer Schottky diodes are designed for RF and microwave mixers and detectors. They include low barrier diodes and zero-bias detectors, combining Skyworks advanced semiconductor technology with low-cost packaging techniques. All diodes are 100% DC tested and deliver tight parameter distribution, minimizing performance variability. They are available in SC-70, SC-79, SC-88, SOD-323, SOT-23, SOT-143, and LGA packages. Wiring configurations include singles, common cathode, series pairs, unconnected pairs and dual series pairs. Applications include low noise receivers used in high-sensitivity ID tags, wireless systems, and radio designs. They may be used at frequencies to 10 GHz. SPICE model parameters are included as a design tool.

NEW Skyworks offers lead (Pb)-free, RoHS (Restriction of Hazardous Substances)-compliant packaging.



Absolute Maximum Ratings





Characteristic	Value
Reverse voltage (V_R)	Rated V_B
Forward current - steady state (I_F)	50 mA
Power dissipation (P_D)	75 mW
Storage temperature (T_{ST})	-65 °C to +150 °C
Operating temperature (T_{OP})	-65 °C to +150 °C
Junction temperature (T_J)	150 °C
Soldering temperature	260 °C for 5 seconds
Electrostatic Discharge (ESD) Human Body Mode (HBM)	Class 0
Electrostatic Discharge (ESD) Charged Device Model (CDM)	Class C4





Performance is guaranteed only under the conditions listed in the specifications table and is not guaranteed under the full range(s) described by the Absolute Maximum specifications. Exceeding any of the absolute maximum/minimum specifications may result in permanent damage to the device and will void the warranty.

CAUTION: Although this device is designed to be as robust as possible, ESD (Electrostatic Discharge) can damage this device. This device must be protected at all times from ESD. Static charges may easily produce potentials of several kilovolts on the human body or equipment, which can discharge without detection. Industry-standard ESD precautions must be employed at all times.

1. SOT-143 (-015) MSL to be defined.

DATA SHEET • SURFACE MOUNT MIXER AND DETECTOR SCHOTTKY DIODES

				
Single	Single	Single	Common Cathode	Series Pair
SC-79	SOD-323	SOT-23		SOT-23
				SMS1546-005 Marking: SG2
				SMS1546-005LF Marking: XG2
◆ SMS7621-079 Marking: Cathode		SMS7621-001 Marking: SH1		◆ SMS7621-005 Marking: SH2
◆ SMS7621-079LF Marking: Cathode		SMS7621-001LF Marking: XH1		◆ SMS7621-005LF Marking: XH2
◆ SMS7630-079 Marking: Anode	SMS7630-011 Marking: SD	SMS7630-001 Marking: SD1		SMS7630-005 Marking: SD2
◆ SMS7630-079LF Marking: Anode	SMS7630-011LF Marking: XD	SMS7630-001LF Marking: XD1		SMS7630-005LF Marking: XD2
$L_S = 0.7 \text{ nH}$	$L_S = 1.5 \text{ nH}$	$L_S = 1.5 \text{ nH}$		$L_S = 1.5 \text{ nH}$
			SC-70	SC-70
			SMS7621-074 Marking: SH3	SMS7621-075 Marking: SH2
			SMS7621-074LF Marking: XH3	SMS7621-075LF Marking: XH2
			$L_S = 1.4 \text{ nH}$	$L_S = 1.4 \text{ nH}$

				
Reverse Series Pair	Unconnected Pair	Reverse Unconnected Pair	Unconnected Pair	Dual Series Pair
SOT-23	SOT-143	SOT-143	LGA	SC-88
◆ SMS7621-006 Marking: SH8	SMS7621-015 Marking: SH7		SMS7621-517 Lead (Pb)-Free Marking: H	
◆ SMS7621-006LF Marking: XH8	SMS7621-015LF Marking: XH7			SMS7621-081LF Marking: XHQ
◆ SMS7630-006 Marking: SD8		◆ SMS7630-020 Marking: SD0	SMS7630-517 Lead (Pb)-Free Marking: D	
◆ SMS7630-006LF Marking: XD8		◆ SMS7630-020LF Marking: XD0		
$L_S = 1.5 \text{ nH}$	$L_S = 1.5 \text{ nH}$	$L_S = 1.5 \text{ nH}$	$L_S = 0.6 \text{ nH}$	$L_S = 1.8 \text{ nH}$

 LF denotes lead (Pb)-free, RoHS-compliant packaging option as an alternative to our standard tin/lead (Sn/Pb) packaging.

 **Innovation to Go™**
Select Linear Products (indicated by ◆) now available for purchase online.

Electrical Specifications at 25 °C (Per Junction)

Low Barrier Mixer and Detectors

Part Number	Barrier	$V_B @ 10 \mu A (V)$	$C_T @ 0 V (pF)$	$V_F @ 1 mA (mV)$	Pair Configuration $\Delta V_F @ 1 mA (mV)$	$R_T^* (\Omega)$
		Min.	Typ.		Max.	Max.
SMS1546 Series	Low	2	0.5	200–270	10	8 @ 10 mA
SMS7621 Series	Low	2	0.25	260–320	10	18 @ 5 mA

* R_T is the slope resistance.

Zero-Bias Detectors

Part Number	$V_B @ 100 \mu A (V)$	$C_T @ 0.15 V (pF)$	$V_F @ 0.1 mA (mV)$	$V_F @ 1 mA (mV)$	Pair Configuration $\Delta V_F @ 1 mA (mV)$	$R_V (\Omega)$
	Min.	Typ.			Max.	Typ.
SMS7630 Series	1	0.3	60–120	135–240	10	5000

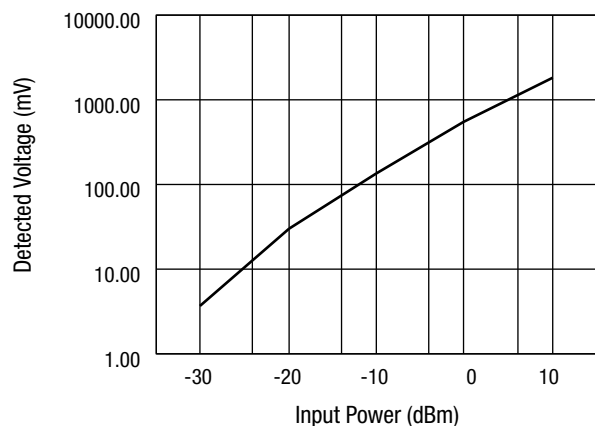

Typical Detector Characteristics @ 1.8 GHz

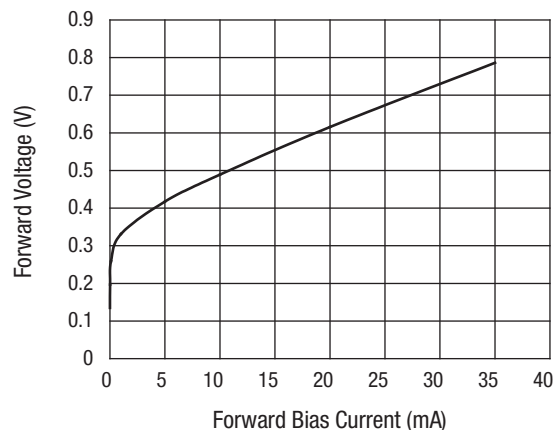

SMS7621-081LF Forward Voltage vs. Forward Bias Current

SPICE Model Parameters (Per Junction)

Parameter	Unit	SMS1546	SMS7621	SMS7630
IS	A	3E-7	4E-8	5E-06
RS	Ω	4	12	20
N		1.04	1.05	1.05
TT	s	1E-11	1E-11	1E-11
CJO	pF	0.38	0.1	0.14
M		0.36	0.35	0.4
EG	eV	0.69	0.69	0.69
XTI		2	2	2
FC		0.5	0.5	0.5
BV	V	3	3	2
IBV	A	1E-5	1E-5	1E-4
VJ	V	0.51	0.51	0.34

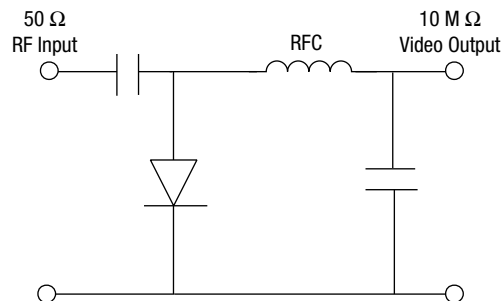

SOT-23

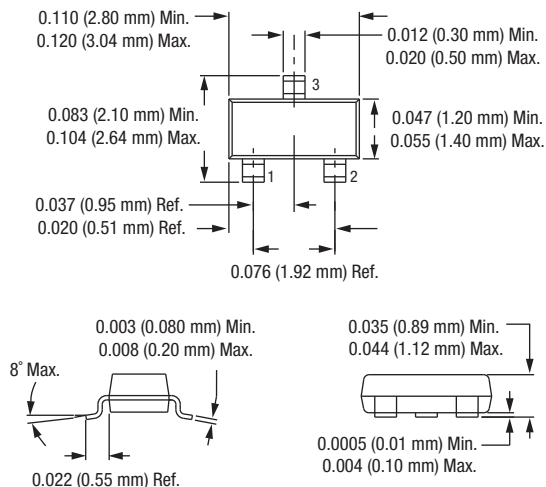

SC-70

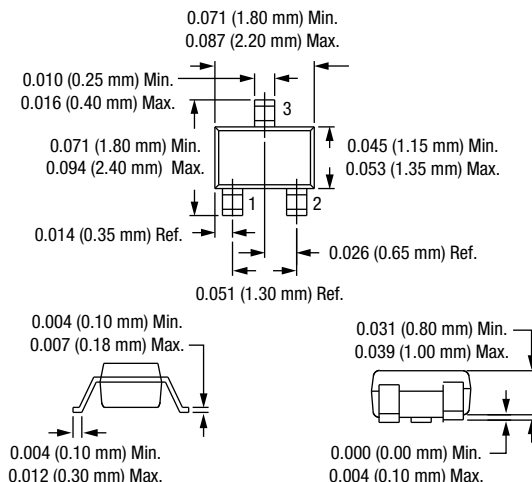

SOD-323

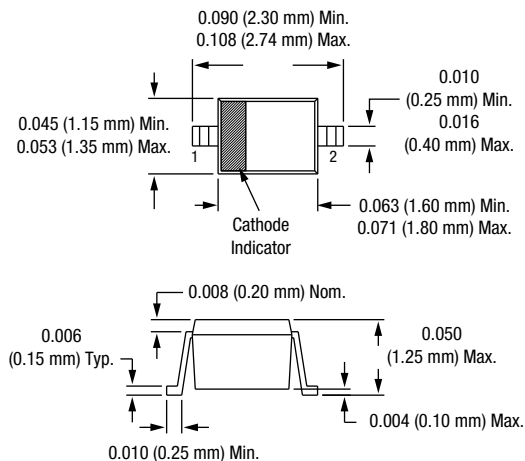

SC-79

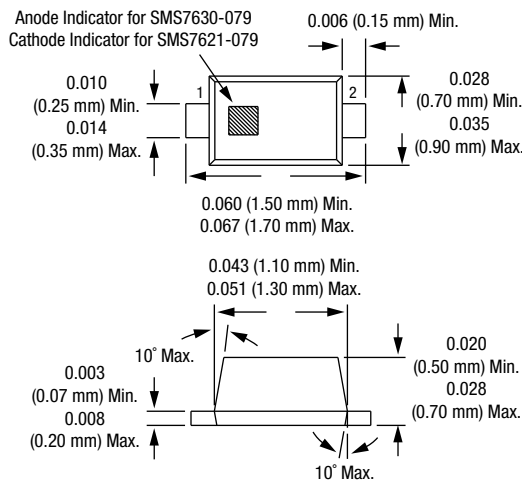

SOT-143

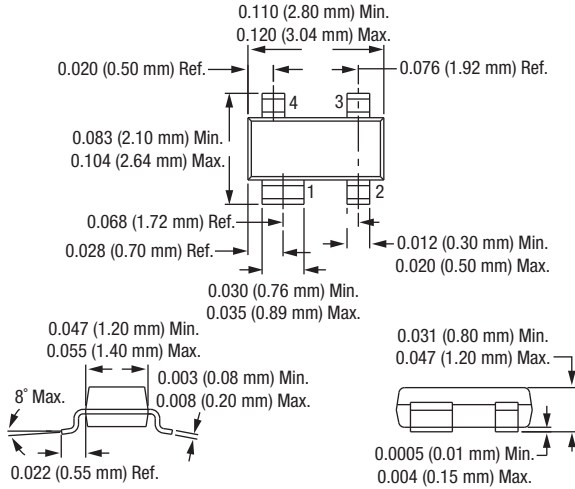

LGA (-517)

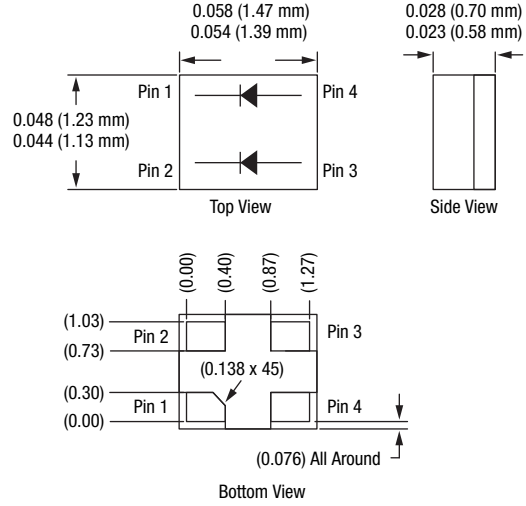

SC-88

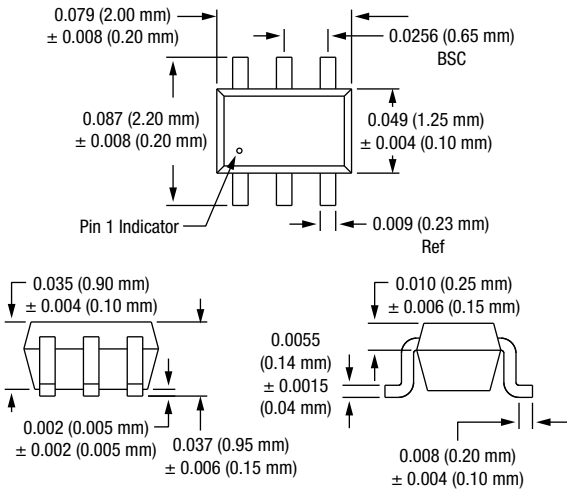

SMS7621-081LF Pin Out (Top View)

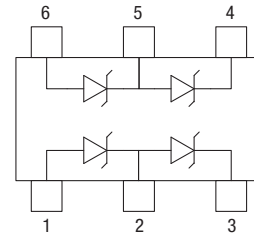

SMS7621-081LF Equivalent Circuit

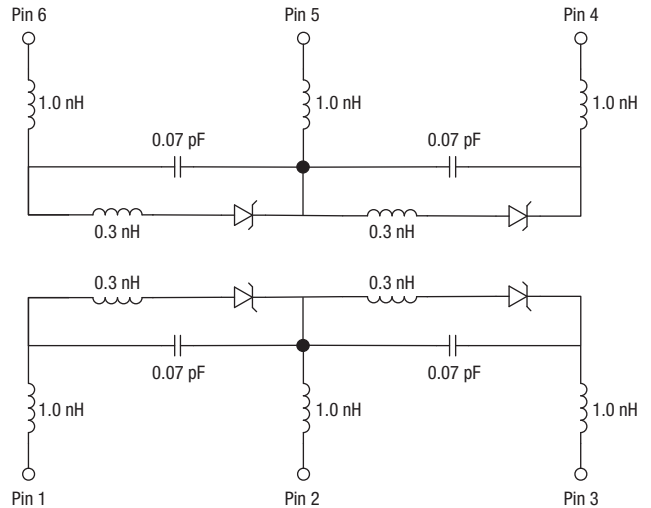

Recommended Solder Reflow Profiles

Refer to the [“Recommended Solder Reflow Profile”](#) Application Note.

Tape and Reel Information

Refer to the [“Discrete Devices and IC Switch/Attenuators Tape and Reel Package Orientation”](#) Application Note.

Copyright © 2002, 2003, 2004, 2005, 2006, 2007, Skyworks Solutions, Inc. All Rights Reserved.

Information in this document is provided in connection with Skyworks Solutions, Inc. ("Skyworks") products or services. These materials, including the information contained herein, are provided by Skyworks as a service to its customers and may be used for informational purposes only by the customer. Skyworks assumes no responsibility for errors or omissions in these materials or the information contained herein. Skyworks may change its documentation, products, services, specifications or product descriptions at any time, without notice. Skyworks makes no commitment to update the materials or information and shall have no responsibility whatsoever for conflicts, incompatibilities, or other difficulties arising from any future changes.

No license, whether express, implied, by estoppel or otherwise, is granted to any intellectual property rights by this document. Skyworks assumes no liability for any materials, products or information provided hereunder, including the sale, distribution, reproduction or use of Skyworks products, information or materials, except as may be provided in Skyworks Terms and Conditions of Sale.

THE MATERIALS, PRODUCTS AND INFORMATION ARE PROVIDED "AS IS" WITHOUT WARRANTY OF ANY KIND, WHETHER EXPRESS, IMPLIED, STATUTORY, OR OTHERWISE, INCLUDING FITNESS FOR A PARTICULAR PURPOSE OR USE, MERCHANTABILITY, PERFORMANCE, QUALITY OR NON-INFRINGEMENT OF ANY INTELLECTUAL PROPERTY RIGHT; ALL SUCH WARRANTIES ARE HEREBY EXPRESSLY DISCLAIMED. SKYWORKS DOES NOT WARRANT THE ACCURACY OR COMPLETENESS OF THE INFORMATION, TEXT, GRAPHICS OR OTHER ITEMS CONTAINED WITHIN THESE MATERIALS. SKYWORKS SHALL NOT BE LIABLE FOR ANY DAMAGES, INCLUDING BUT NOT LIMITED TO ANY SPECIAL, INDIRECT, INCIDENTAL, STATUTORY, OR CONSEQUENTIAL DAMAGES, INCLUDING WITHOUT LIMITATION, LOST REVENUES OR LOST PROFITS THAT MAY RESULT FROM THE USE OF THE MATERIALS OR INFORMATION, WHETHER OR NOT THE RECIPIENT OF MATERIALS HAS BEEN ADVISED OF THE POSSIBILITY OF SUCH DAMAGE.

Skyworks products are not intended for use in medical, lifesaving or life-sustaining applications, or other equipment in which the failure of the Skyworks products could lead to personal injury, death, physical or environmental damage. Skyworks customers using or selling Skyworks products for use in such applications do so at their own risk and agree to fully indemnify Skyworks for any damages resulting from such improper use or sale.

Customers are responsible for their products and applications using Skyworks products, which may deviate from published specifications as a result of design defects, errors, or operation of products outside of published parameters or design specifications. Customers should include design and operating safeguards to minimize these and other risks. Skyworks assumes no liability for applications assistance, customer product design, or damage to any equipment resulting from the use of Skyworks products outside of stated published specifications or parameters.

Skyworks, the Skyworks symbol, "Breakthrough Simplicity" and "Innovation to Go" are trademarks or registered trademarks of Skyworks Solutions, Inc., in the United States and other countries. Third-party brands and names are for identification purposes only, and are the property of their respective owners. Additional information, including relevant terms and conditions, posted at www.skyworksinc.com, are incorporated by reference.