

# 2-Wire-Interfaced 16-Bit I/O Port Expander with Interrupt and Hot-Insertion Protection

## General Description

The MAX7311 2-wire-interfaced expander provides 16-bit parallel input/output (I/O) port expansion for SMBus™ and I<sup>2</sup>C applications. The MAX7311 consists of input port registers, output port registers, polarity inversion registers, configuration registers, a bus timeout register, and an I<sup>2</sup>C-compatible serial interface logic compatible with SMBus. The system master can invert the MAX7311 input data by writing to the active-high polarity inversion register. The system master can enable or disable bus timeout by writing to the bus timeout register.

Any of the 16 I/O ports can be configured as an input or output. A power-on reset (POR) initializes the 16 I/Os as inputs. Three address select pins configure one of 64 slave ID addresses.

The MAX7311 supports hot insertion. All port pins, the INT output, SDA, SCL and the slave address inputs AD0–2 remain high impedance in power down (V+ = 0V) with up to 6V asserted upon them.

The MAX7311 is available in 24-pin SO, SSOP, TSSOP, and thin QFN packages and is specified over the -40°C to +125°C automotive temperature range.

For applications requiring I/Os without pullup resistors, refer to the MAX7312 data sheet.

## Applications

Servers  
RAID Systems  
Industrial Control  
Medical Equipment  
PLCs  
Instrumentation and Test Measurement

## Pin Configurations

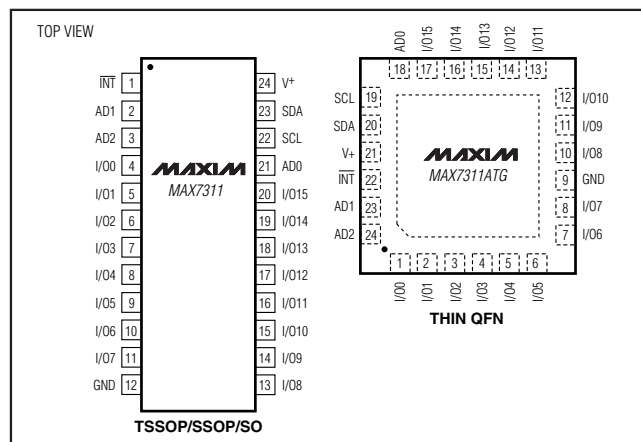

## Features

- ◆ 400kbps I<sup>2</sup>C-Compatible Serial Interface
- ◆ 2V to 5.5V Operation
- ◆ 5V Overvoltage Tolerant I/Os
- ◆ Supports Hot Insertion
- ◆ 16 I/O Pins that Default to Inputs on Power-Up
- ◆ 100kΩ Pullup on Each I/O
- ◆ Open-Drain Interrupt Output ( $\overline{\text{INT}}$ )
- ◆ Bus Timeout for Lock-Up-Free Operation
- ◆ Noise Filter on SCL / SDA Inputs
- ◆ 64 Slave ID Addresses Available
- ◆ Low Standby Current (2.9μA typ)
- ◆ Polarity Inversion
- ◆ 4mm × 4mm, 0.8mm Thin QFN Package
- ◆ -40°C to +125°C Operation

## Ordering Information

PART	TEMP RANGE	PIN-PACKAGE	PKG CODE
MAX7311AWG	-40°C to +125°C	24 Wide SO	—
MAX7311AAG	-40°C to +125°C	24 SSOP	—
MAX7311ATG	-40°C to +125°C	24 Thin QFN (4mm × 4mm)	T2444-4
MAX7311AUG	-40°C to +125°C	24 TSSOP	—

SMBus is a trademark of Intel Corp.

# 2-Wire-Interfaced 16-Bit I/O Port Expander with Interrupt and Hot-Insertion Protection

## ABSOLUTE MAXIMUM RATINGS

V <sup>+</sup> to GND .....	-0.3V to +6V
I/O0–I/O15 as Inputs .....	(GND - 0.3V) to +6V
SCL, SDA, AD0, AD1, AD2, INT .....	(GND - 0.3V) to +6V
Maximum V <sup>+</sup> Current .....	+250mA
Maximum GND Current .....	-250mA
DC Input Current on I/O0–I/O15 .....	±20mA
DC Output Current on I/O0–I/O15 .....	±80mA

Continuous Power Dissipation (T <sub>A</sub> = +70°C)	
24-Pin Wide SO (derate 11.8mW/°C above +70°C) ....	941mW
24-Pin SSOP (derate 8.0mW/°C above +70°C) .....	640mW
24-Pin TSSOP (derate 12.2mW/°C above +70°C) .....	975mW
24-Pin Thin QFN (derate 20.8mW/°C above +70°C) .	1668mW
Operating Temperature Range .....	-40°C to +125°C
Junction Temperature .....	+150°C
Storage Temperature Range .....	-65°C to +150°C
Lead Temperature (soldering, 10s) .....	+300°C

Stresses beyond those listed under "Absolute Maximum Ratings" may cause permanent damage to the device. These are stress ratings only, and functional operation of the device at these or any other conditions beyond those indicated in the operational sections of the specifications is not implied. Exposure to absolute maximum rating conditions for extended periods may affect device reliability.

## DC ELECTRICAL CHARACTERISTICS

(V<sup>+</sup> = 2V to 5.5V, T<sub>A</sub> = -40°C to +125°C, unless otherwise noted. Typical values are at V<sup>+</sup> = 3.3V, T<sub>A</sub> = +25°C.) (Note 1)

PARAMETER	SYMBOL	CONDITIONS	MIN	TYP	MAX	UNITS
Supply Voltage	V <sup>+</sup>		2		5.5	V
Supply Current	I <sup>+</sup>	All I/Os unloaded, f <sub>SCL</sub> = 400kHz	V <sup>+</sup> = 2V	23	35	μA
			V <sup>+</sup> = 3.3V	43	60	
			V <sup>+</sup> = 5.5V	80	120	
Standby Current	I <sub>STBY</sub>	All I/Os unloaded, f <sub>SCL</sub> = 0	V <sup>+</sup> = 2V	2.3	11	μA
			V <sup>+</sup> = 3.3V	2.9	12	
			V <sup>+</sup> = 5.5V	3.8	15.5	
Power-On Reset Voltage	V <sub>POR</sub>		1.4	1.7		V
<b>SCL, SDA</b>						
Input Voltage Low	V <sub>IL</sub>				0.3 × V <sup>+</sup>	V
Input Voltage High	V <sub>IH</sub>		0.7 × V <sup>+</sup>			V
Low-Level Output Voltage	V <sub>OL</sub>	I <sub>SINK</sub> = 6mA			0.4	V
Leakage Current	I <sub>L</sub>		-1		+1	μA
Input Capacitance				10		pF
<b>I/O<sub>0</sub></b>						
Input Voltage Low	V <sub>IL</sub>				0.8	V
Input Voltage High	V <sub>IH</sub>		1.8			V
Input Leakage Current		T <sub>A</sub> = -40°C to +85°C; includes internal pullup current, V <sub>IO</sub> = V <sup>+</sup>			1	μA
Internal Pullup Current		T <sub>A</sub> = -40°C to +85°C, V <sub>IO</sub> = 0		34	100	μA
Low-Level Output Current	I <sub>SINK</sub>	V <sup>+</sup> = 2V, V <sub>OL</sub> = 0.5V	8.5	17		mA
		V <sup>+</sup> = 3.3V, V <sub>OL</sub> = 0.5V	17	32		
		V <sup>+</sup> = 5V, V <sub>OL</sub> = 0.5V		43		
High Output Current	I <sub>SOURCE</sub>	V <sup>+</sup> = 3.3V, V <sub>OH</sub> = 2.4V	29	41		mA
		V <sup>+</sup> = 5V, V <sub>OH</sub> = 4.5V		31		
<b>AD0, AD1, AD2</b>						
Input Voltage Low	V <sub>IL</sub>				0.3 × V <sup>+</sup>	V
Input Voltage High	V <sub>IH</sub>		0.7 × V <sup>+</sup>			V

# 2-Wire-Interfaced 16-Bit I/O Port Expander with Interrupt and Hot-Insertion Protection

MAX7311

## DC ELECTRICAL CHARACTERISTICS (continued)

(V<sup>+</sup> = 2V to 5.5V, T<sub>A</sub> = -40°C to +125°C, unless otherwise noted. Typical values are at V<sup>+</sup> = 3.3V, T<sub>A</sub> = +25°C.) (Note 1)

PARAMETER	SYMBOL	CONDITIONS	MIN	TYP	MAX	UNITS
Leakage Current			-1		+1	μA
Input Capacitance				4		pF
<b>INT</b>						
Low-Level Output Current	I <sub>OL</sub>	V <sub>OL</sub> = 0.4V	6			mA

## AC ELECTRICAL CHARACTERISTICS

(V<sup>+</sup> = 2V to 5.5V, T<sub>A</sub> = -40°C to +125°C, unless otherwise noted.) (Note 1)

PARAMETER	SYMBOL	CONDITIONS	MIN	TYP	MAX	UNITS
SCL Clock Frequency	f <sub>SCL</sub>	(Note 2)			400	kHz
Bus Timeout	t <sub>TIMEOUT</sub>		29		61	ms
Bus Free Time Between STOP and START Conditions	t <sub>BUF</sub>	Figure 2	1.3			μs
Hold Time (Repeated) START Condition	t <sub>HD,STA</sub>	Figure 2	0.6			μs
Repeated START Condition Setup Time	t <sub>SU,STA</sub>	Figure 2	0.6			μs
STOP Condition Setup Time	t <sub>SU,STO</sub>	Figure 2	0.6			μs
Data Hold Time	t <sub>HD,DAT</sub>	Figure 2 (Note 3)			0.9	μs
Data Setup Time	t <sub>SU,DAT</sub>	Figure 2	100			ns
SCL Low Period	t <sub>LOW</sub>	Figure 2	1.3			μs
SCL High Period	t <sub>HIGH</sub>	Figure 2	0.7			μs
SDA Fall Time	t <sub>F</sub>	Figure 2 (Notes 4, 5)	V <sup>+</sup> < 3.3V		500	ns
			V <sup>+</sup> ≥ 3.3V		250	
Pulse Width of Spike Suppressed	t <sub>SP</sub>	(Note 6)		50		ns
<b>PORT TIMING</b>						
Output Data Valid	t <sub>PV</sub>	Figure 7			3	μs
Input Data Setup Time			27			μs
Input Data Hold Time			0			μs
<b>INTERRUPT TIMING</b>						
Interrupt Valid	t <sub>IV</sub>	Figure 9			30.5	μs
Interrupt Reset	t <sub>IR</sub>	Figure 9			2	μs

**Note 1:** All parameters are 100% production tested at T<sub>A</sub> = +25°C. Specifications over temperature are guaranteed by design.

**Note 2:** Minimum SCL clock frequency is limited by the MAX7311 bus timeout feature, which resets the serial bus interface if either SDA or SCL is held low for a minimum of 25ms. Disable bus timeout feature for DC operation.

**Note 3:** A master device must internally provide a hold time of at least 300ns for the SDA signal (referred to the V<sub>IL</sub> of the SCL signal) in order to bridge the undefined region SCL's falling edge.

**Note 4:** C<sub>B</sub> = total capacitance of one bus line in pF.

**Note 5:** The maximum t<sub>F</sub> for the SDA and SCL bus lines is specified at 300ns. The maximum fall time for the SDA output stage t<sub>F</sub> is specified at 250ns. This allows series protection resistors to be connected between the SDA and SCL pins and the SDA/SCL bus lines without exceeding the maximum specified t<sub>F</sub>.

**Note 6:** Input filters on the SDA and SCL inputs suppress noise spikes less than 50ns.

# 2-Wire-Interfaced 16-Bit I/O Port Expander with Interrupt and Hot-Insertion Protection

## Typical Operating Characteristics

( $T_A = +25^\circ\text{C}$ , unless otherwise noted.)

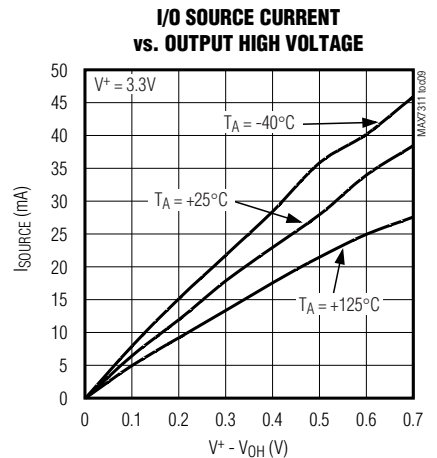
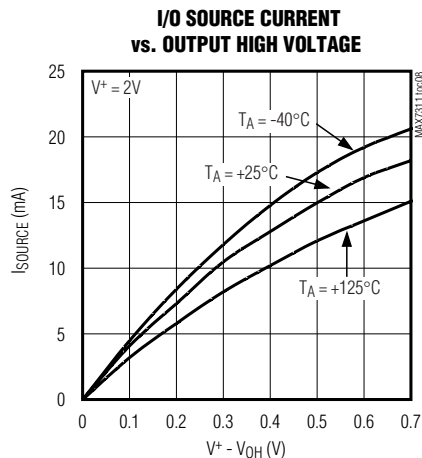
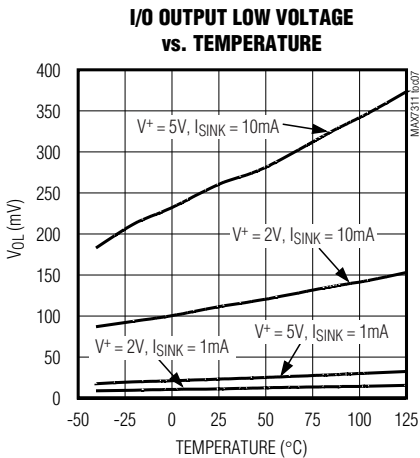
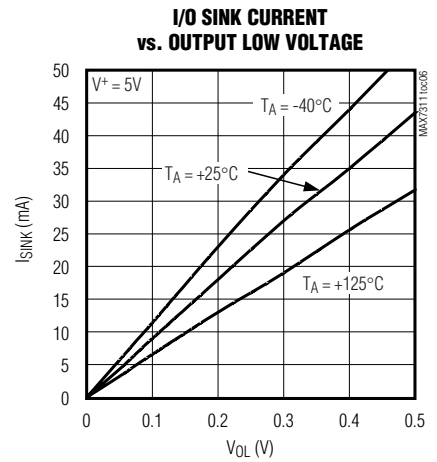
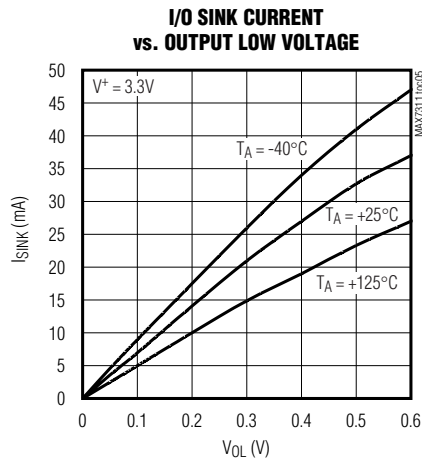
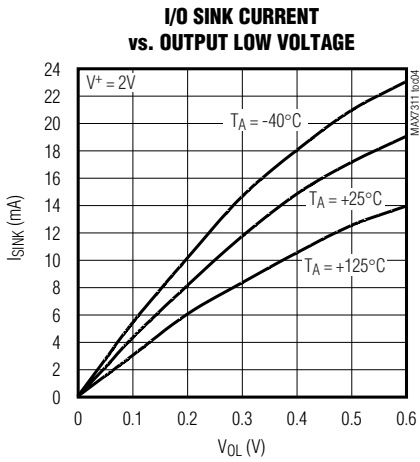
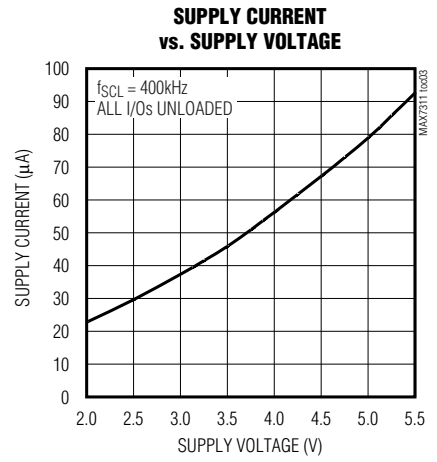
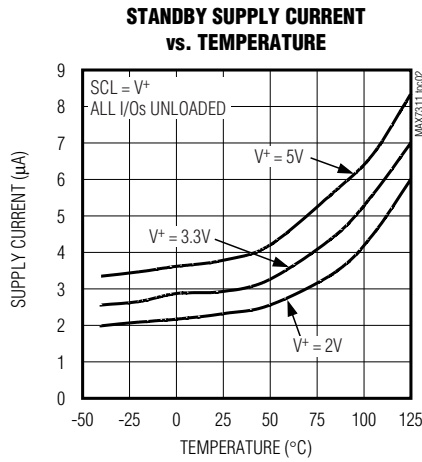
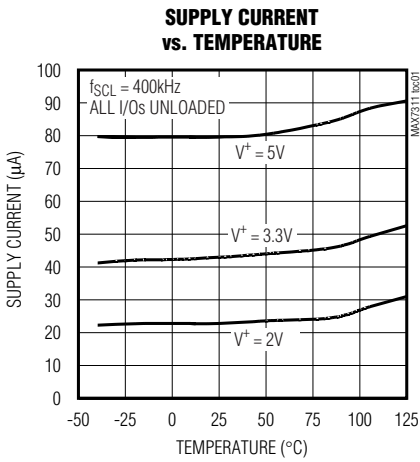

# 2-Wire-Interfaced 16-Bit I/O Port Expander with Interrupt and Hot-Insertion Protection

MAX7311

## Typical Operating Characteristics (continued)

( $T_A = +25^\circ\text{C}$ , unless otherwise noted.)

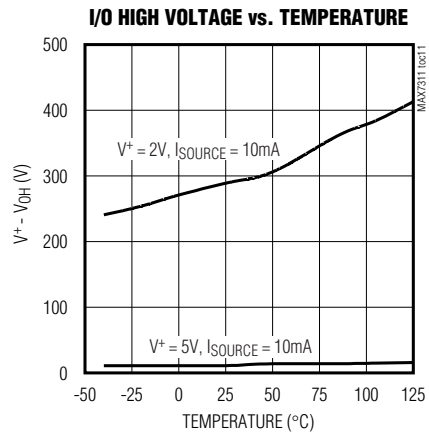
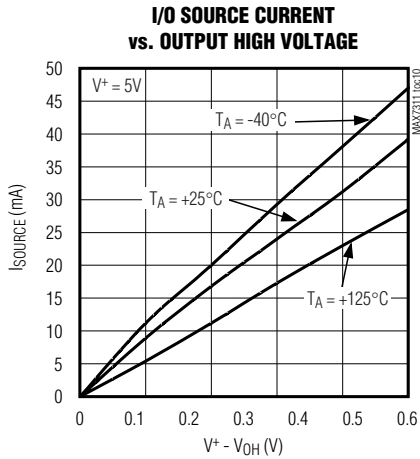

## Pin Description

PIN		NAME	FUNCTION
TSSOP/ SSOP/SO	THIN QFN		
1	22	$\overline{\text{INT}}$	Interrupt Output (Open Drain)
2	23	AD1	Address Input 1
3	24	AD2	Address Input 2
4-11	1-8	I/O0-I/O7	Input/Output Port 1
12	9	GND	Supply Ground
13-20	10-17	I/O8-I/O15	Input/Output Port 2
21	18	AD0	Address Input 0
22	19	SCL	Serial Clock Line
23	20	SDA	Serial Data Line
24	21	V <sup>+</sup>	Supply Voltage. Bypass with a 0.047 $\mu\text{F}$ capacitor to GND.
—	PAD	Exposed pad	Exposed Pad on Package Underside. Connect to GND.

# 2-Wire-Interfaced 16-Bit I/O Port Expander with Interrupt and Hot-Insertion Protection

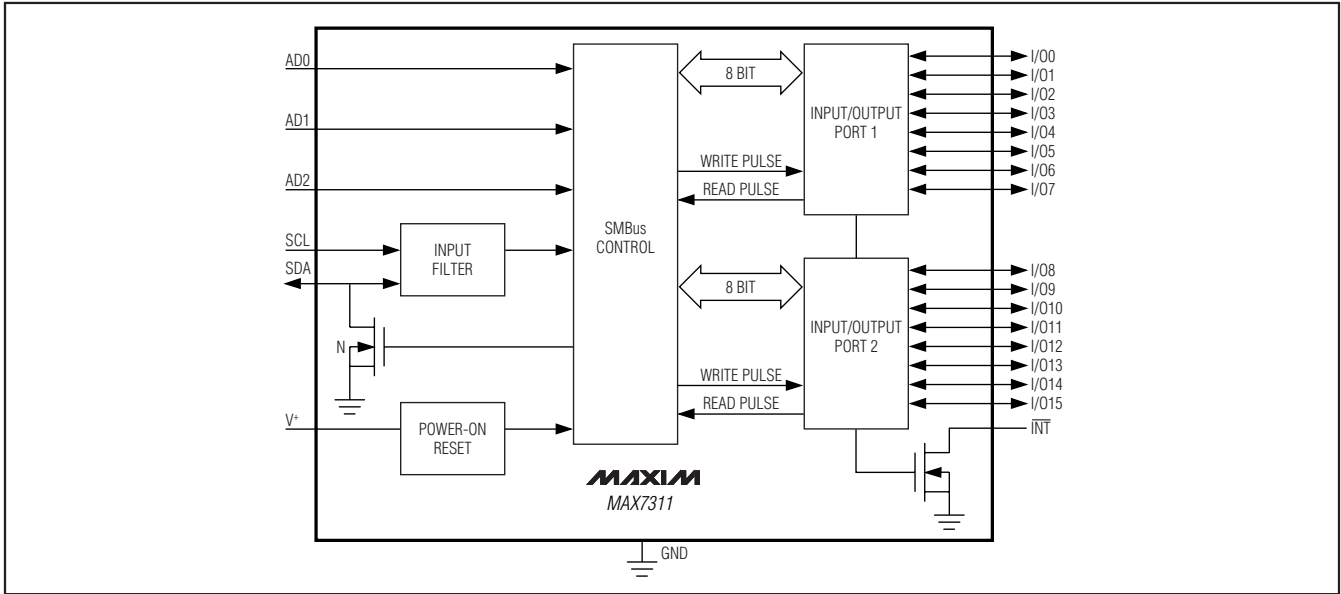

Figure 1. MAX7311 Block Diagram

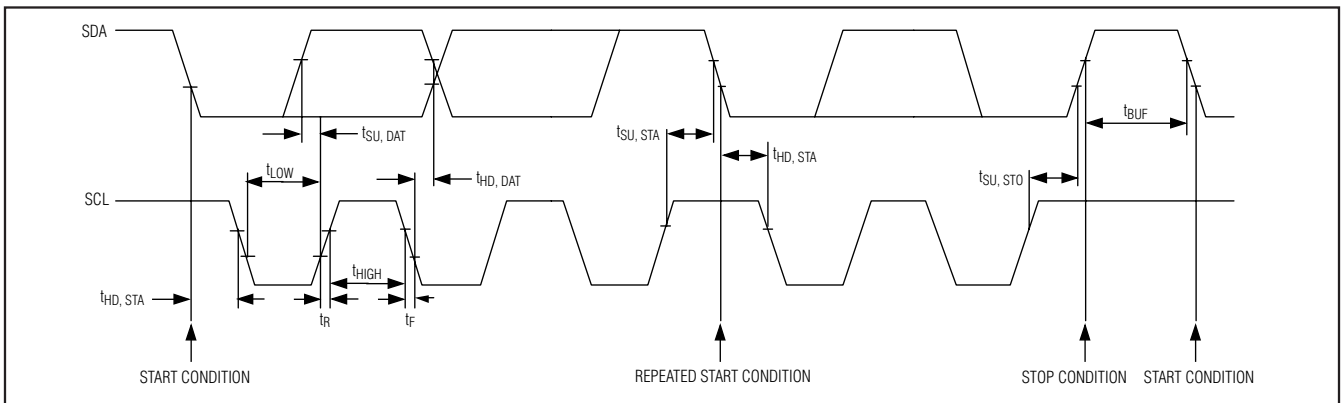

Figure 2. 2-Wire Serial Interface Timing Diagram

## Detailed Description

The MAX7311 general-purpose input/output (GPIO) peripheral provides up to 16 I/O ports, controlled through an I<sup>2</sup>C-compatible serial interface. The MAX7311 consists of input port registers, output port registers, polarity inversion registers, configuration registers, and a bus-timeout register. Upon power-on, all I/O lines are set as inputs. Three slave ID address select pins, AD0, AD1, and AD2, choose one of 64 slave ID addresses, including the eight addresses supported by the Phillips PCA9555. Table 1 is the register address table. Tables 2–6 show detailed register information.

## Serial Interface

### Serial Addressing

The MAX7311 operates as a slave that sends and receives data through a 2-wire interface. The interface uses a serial data line (SDA) and a serial clock line (SCL) to achieve bidirectional communication between master(s) and slave(s). A master, typically a microcontroller, initiates all data transfers to and from the MAX7311, and generates the SCL clock that synchronizes the data transfer (Figure 2).

# 2-Wire-Interfaced 16-Bit I/O Port Expander with Interrupt and Hot-Insertion Protection

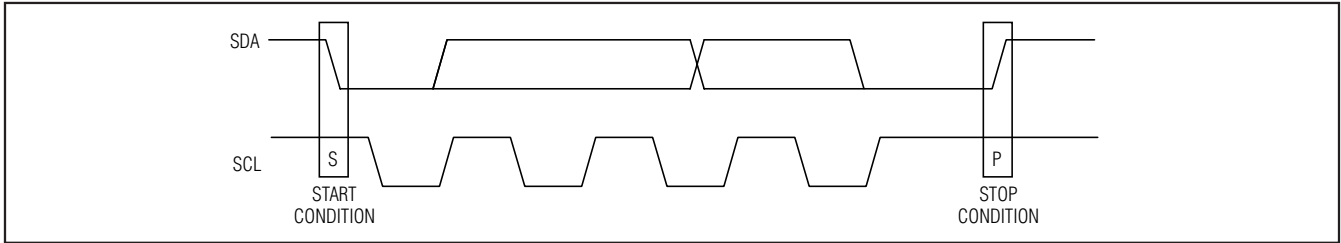

Figure 3. START and STOP Conditions

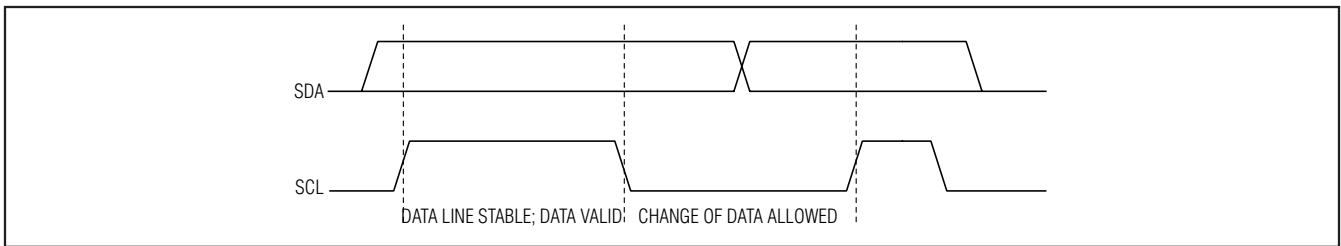

Figure 4. Bit Transfer

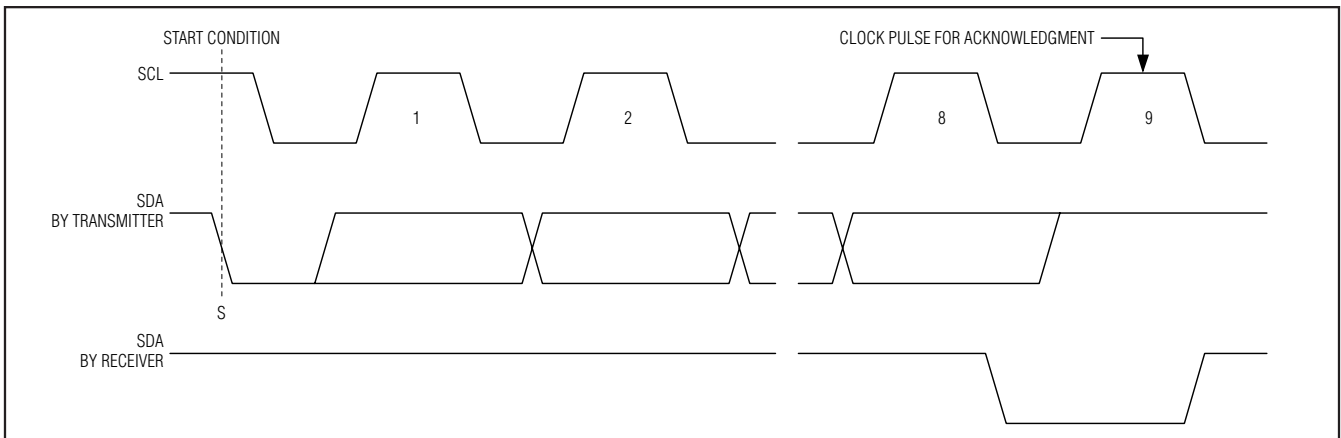

Figure 5. Acknowledge

Each transmission consists of a START condition sent by a master, followed by the MAX7311 7-bit slave address plus R/W bit, a register address byte, 1 or more data bytes, and finally a STOP condition (Figure 3).

### START and STOP Conditions

Both SCL and SDA remain high when the interface is not busy. A master signals the beginning of a transmission with a START (S) condition by transitioning SDA from high to low while SCL is high. When the master has finished communicating with the slave, it issues a STOP (P) condition by transitioning SDA from low to high while SCL is high. The bus is then free for another transmission (Figure 3).

### Bit Transfer

One data bit is transferred during each clock pulse. The data on SDA must remain stable while SCL is high (Figure 4).

### Acknowledge

The acknowledge bit is a clocked 9th bit, which the recipient uses as a handshake receipt of each byte of data (Figure 5). Thus, each byte transferred effectively requires 9 bits. The master generates the 9th clock pulse, and the recipient pulls down SDA during the acknowledge clock pulse, such that the SDA line is stable low during the high period of the clock pulse. When the master is transmitting to the MAX7311, the

# 2-Wire-Interfaced 16-Bit I/O Port Expander with Interrupt and Hot-Insertion Protection

MAX7311 generates the acknowledge bit since the MAX7311 is the recipient. When the MAX7311 is transmitting to the master, the master generates the acknowledge bit.

### Slave Address

The MAX7311 has a 7-bit-long slave address (Figure 6). The 8th bit following the 7-bit slave address is the R/W bit. Set this bit low for a write command and high for a read command.

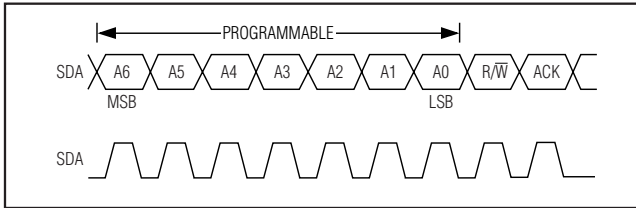

Figure 6. Slave Address

Slave address pins AD2, AD1, and AD0 choose 1 of 64 slave ID addresses (Table 7).

### Data Bus Transaction

The command byte is the first byte to follow the 8-bit device slave address during a write transmission (Table 1, Figure 7). The command byte is used to determine which of the following registers are written or read.

### Writing to Port Registers

Transmit data to the MAX7311 by sending the device slave address and setting the LSB to a logic zero. The command byte is sent after the address and determines which registers receive the data following the command byte (Figure 7).

Table 1. Command Byte Register

COMMAND BYTE ADDRESS (HEX)	FUNCTION	PROTOCOL	POWER-UP DEFAULT
0x00	Input port 1	Read byte	XXXX XXXX
0x01	Input port 2	Read byte	XXXX XXXX
0x02	Output port 1	Read/write byte	1111 1111
0x03	Output port 2	Read/write byte	1111 1111
0x04	Port 1 polarity inversion	Read/write byte	0000 0000
0x05	Port 2 polarity inversion	Read/write byte	0000 0000
0x06	Port 1 configuration	Read/write byte	1111 1111
0x07	Port 2 configuration	Read/write byte	1111 1111
0x08	Timeout register	Read/write byte	0000 0001
0xFF	Factory reserved. (Do not write to this register.)	—	—

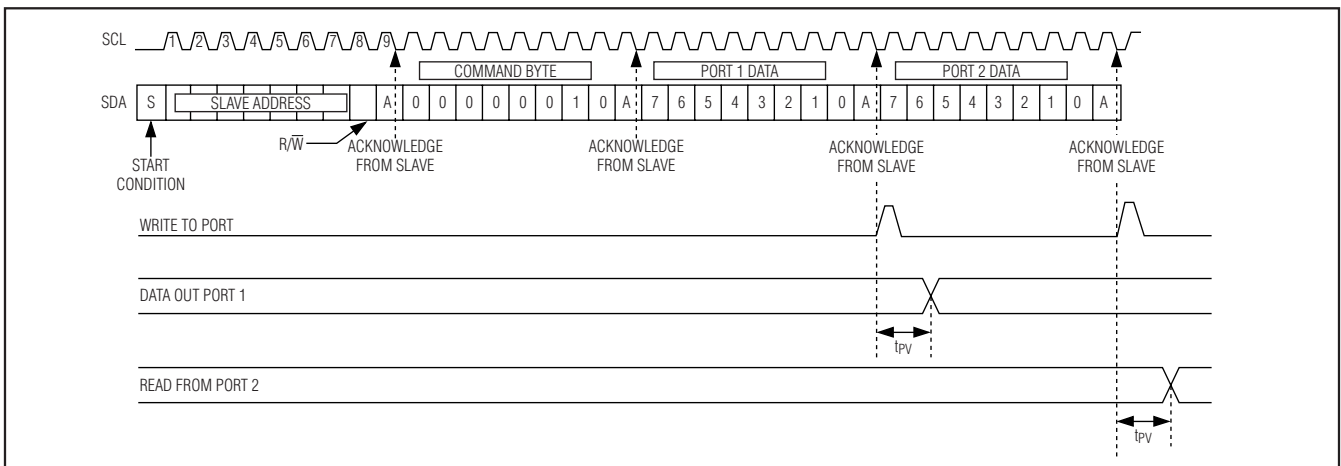

Figure 7. Writes to Output Registers Through Write Byte Protocol



# 2-Wire-Interfaced 16-Bit I/O Port Expander with Interrupt and Hot-Insertion Protection

Eight of the MAX7311's nine registers are configured to operate as four register pairs: input ports, output ports, polarity inversion ports, and configuration ports. After sending 1 byte of data to one register, the next byte is sent to the other register in the pair. For example, if the first byte of data is sent to output port 2, then the next byte of data is stored in output port 1. An unlimited number of data bytes can be sent in one write transmission. This allows each 8-bit register to be updated independently of the other registers.

## Reading Port Registers

To read the device data, the bus master must first send the MAX7311 address with the R/W bit set to zero, followed by the command byte, which determines which register is accessed. After a restart, the bus master must then send the MAX7311 address with the R/W bit set to 1. Data from the register defined by the command byte is then sent from the MAX7311 to the master (Figures 8, 9).

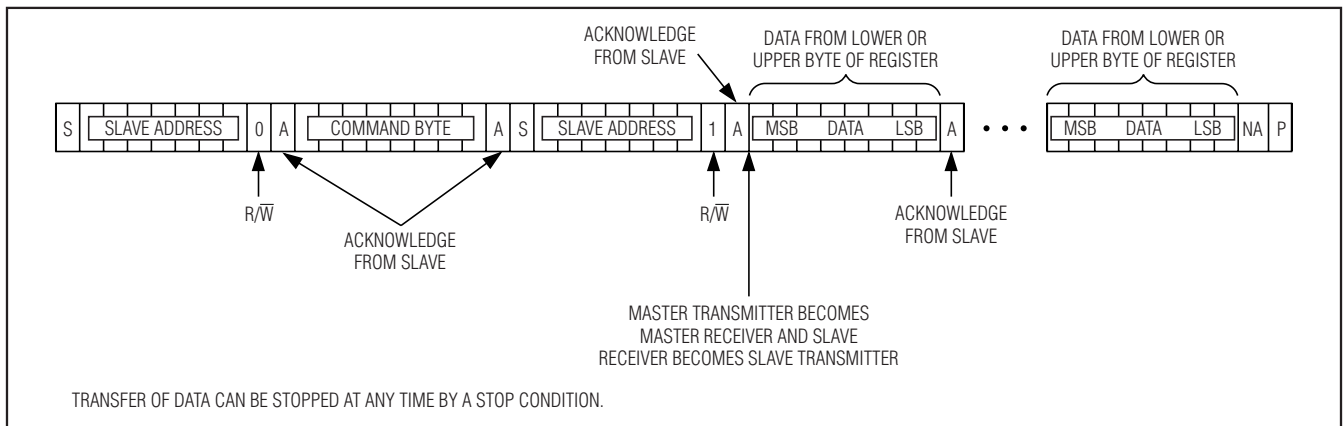

Figure 8. Read from Register

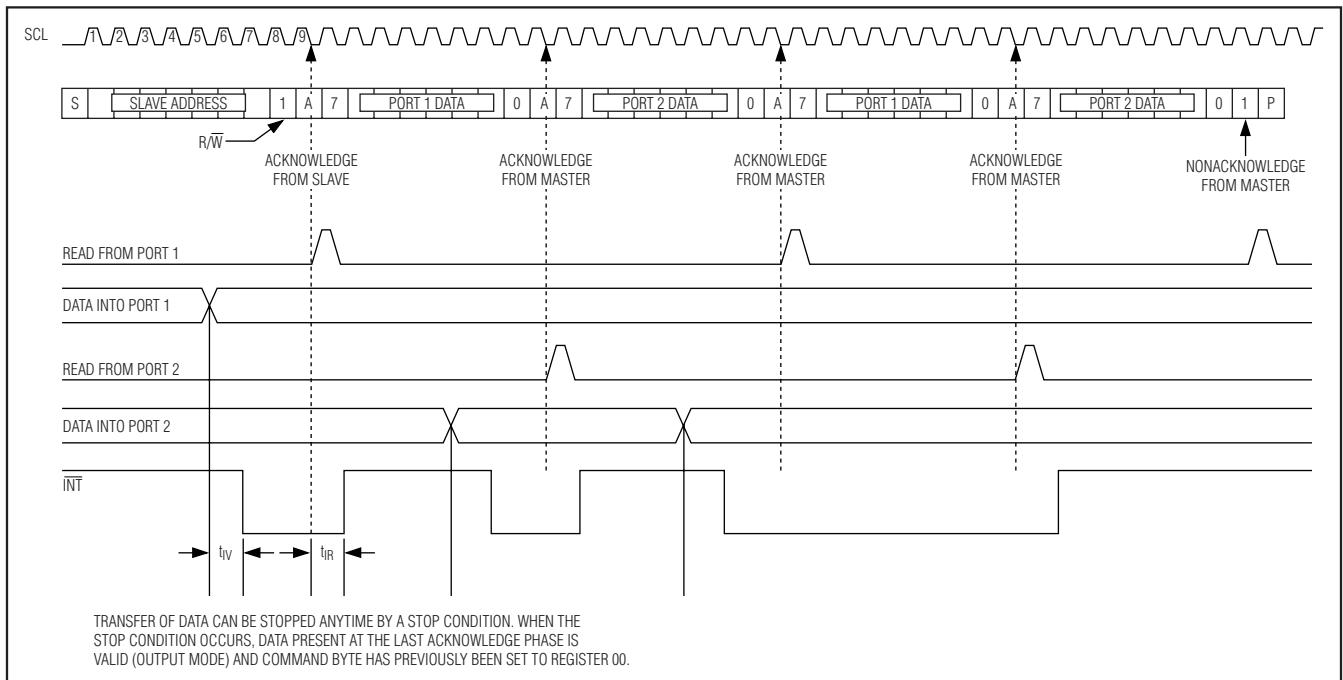

Figure 9. Read from Input Registers

## 2-Wire-Interfaced 16-Bit I/O Port Expander with Interrupt and Hot-Insertion Protection

Data is clocked into a register on the falling edge of the acknowledge clock pulse. After reading the first byte, additional bytes may be read and reflect the content in the other register in the pair. For example, if input port 1 is read, the next byte read is input port 2. An unlimited number of data bytes can be read in one read transmission, but the final byte received must not be acknowledged by the bus master.

### Interrupt ( $\overline{INT}$ )

The open-drain interrupt output,  $\overline{INT}$ , activates when one of the port pins changes states and only when the pin is configured as an input. The interrupt deactivates when the input returns to its previous state or the input register is read (Figure 9). A pin configured as an output does not cause an interrupt. Each 8-bit port register is read independently; therefore, an interrupt caused by port 1 is not cleared by a read of port 2's register.

Changing an I/O from an output to an input may cause a false interrupt to occur if the state of that I/O does not match the content of the input port register.

### Input/Output Port

When an I/O is configured as an input, FETs Q1 and Q2 are off (Figure 10), creating a high-impedance input with a nominal  $100\text{k}\Omega$  pullup to  $V^+$ . All inputs are overvoltage protected to 5.5V, independent of supply voltage. When a port is configured as an output, either Q1 or Q2 is on, depending on the state of the output port register. When  $V^+$  powers up, an internal power-on reset sets all registers to their respective defaults (Table 1).

### Input Port Registers

The input port registers (Table 2) are read-only ports. They reflect the incoming logic levels of the pins, regardless of whether the pin is defined as an input or an output by the respective configuration register. A read of the input port 1 register latches the current value of I/O0–I/O7. A read of the input port 2 register latches the current value of I/O8–I/O15. Writes to the input port registers are ignored.

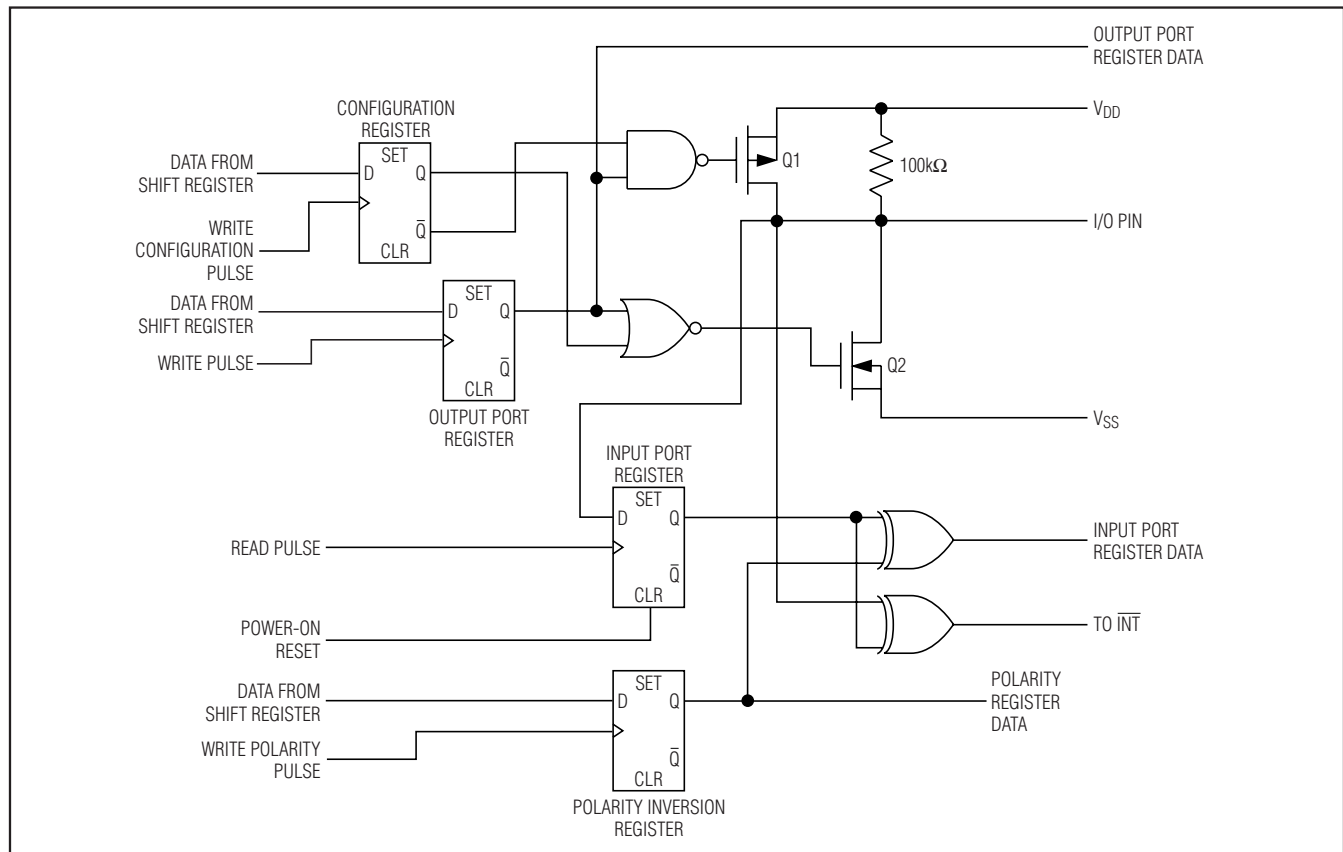

Figure 10. Simplified Schematic of I/Os

## 2-Wire-Interfaced 16-Bit I/O Port Expander with Interrupt and Hot-Insertion Protection

**Table 2. Registers 0x00, 0x01—Input Port Registers**

BIT	I7	I6	I5	I4	I3	I2	I1	I0
		I15	I14	I13	I12	I11	I10	I9

**Table 3. Registers 0x02, 0x03—Output Port Registers**

BIT	O7	O6	O5	O4	O3	O2	O1	O0
		O15	O14	O13	O12	O11	O10	O9
Power-up default	1	1	1	1	1	1	1	1

**Table 4. Registers 0x04, 0x05—Polarity Inversion Registers**

BIT	I/O7	I/O6	I/O5	I/O4	I/O3	I/O2	I/O1	I/O0
		I/O15	I/O14	I/O13	I/O12	I/O11	I/O10	I/O9
Power-up default	0	0	0	0	0	0	0	0

**Table 5. Registers 0x06, 0x07—Configuration Registers**

BIT	I/O7	I/O6	I/O5	I/O4	I/O3	I/O2	I/O1	I/O0
		I/O15	I/O14	I/O13	I/O12	I/O11	I/O10	I/O9
Power-up default	1	1	1	1	1	1	1	1

**Table 6. Register 0x08—Timeout Register**

BIT	7	6	5	4	3	2	1	0
Power-up default	0	0	0	0	0	0	0	1

### Output Port Registers

The output port registers (Table 3) set the outgoing logic levels of the I/Os defined as outputs by the respective configuration register. Reads from the output port registers reflect the value that is in the flip-flop controlling the output selection, not the actual I/O value.

### Polarity Inversion Registers

The polarity inversion registers (Table 4) enable polarity inversion of pins defined as inputs by the respective port configuration registers. Set the bit in the polarity inversion register to invert the corresponding port pin's polarity. Clear the bit in the polarity inversion register to retain the corresponding port pin's original polarity.

### Configuration Registers

The configuration registers (Table 5) configure the directions of the I/O pins. Set the bit in the respective configuration register to enable the corresponding port as an input. Clear the bit in the configuration register to enable the corresponding port as an output.

### Bus Timeout

Set register 0x08 LSB (bit 0) to enable the bus timeout function (Table 6) or clear it to disable the bus timeout function. Enabling the timeout feature resets the MAX7311 serial bus interface when SCL stops either high or low during a read or write. If either SCL or SDA is low for more than 29ms after the start of a valid serial transfer, the interface resets itself and sets up SDA as an input. The MAX7311 then waits for another START condition.

### Standby

The MAX7311 goes into standby when the I<sup>2</sup>C bus is idle. Standby supply current is typically 2.9μA.

## Applications Information

### Hot Insertion

The I/O ports I/O0–I/O15, interrupt output  $\overline{INT}$ , and serial interface SDA, SCL, AD0–2 remain high impedance with up to 6V asserted on them when the MAX7311 is powered down ( $V_+ = 0V$ ). The MAX7311 can therefore be used in hot-swap applications. Note that each I/O's 100kΩ pullup effectively becomes a 100kΩ pulldown when the MAX7311 is powered down.

### Power-Supply Consideration

The MAX7311 operates from a supply voltage of 2V to 5.5V. Bypass the power supply to GND with a 0.047μF capacitor as close to the device as possible. For the QFN version, connect the exposed pad to GND.

## 2-Wire-Interfaced 16-Bit I/O Port Expander with Interrupt and Hot-Insertion Protection

Table 7. MAX7311 Address Map

AD2	AD1	AD0	A6	A5	A4	A3	A2	A1	A0	ADDRESS (HEX)
<b>GND</b>	<b>SCL</b>	<b>GND</b>	<b>0</b>	<b>0</b>	<b>1</b>	<b>0</b>	<b>0</b>	<b>0</b>	<b>0</b>	<b>0x20</b>
GND	SCL	V <sup>+</sup>	0	0	1	0	0	0	1	0x22
GND	SDA	GND	0	0	1	0	0	1	0	0x24
GND	SDA	V <sup>+</sup>	0	0	1	0	0	1	1	0x26
V <sup>+</sup>	SCL	GND	0	0	1	0	1	0	0	0x28
V <sup>+</sup>	SCL	V <sup>+</sup>	0	0	1	0	1	0	1	0x2A
V <sup>+</sup>	SDA	GND	0	0	1	0	1	1	0	0x2C
V <sup>+</sup>	SDA	V <sup>+</sup>	0	0	1	0	1	1	1	0x2E
<b>GND</b>	<b>SCL</b>	<b>SCL</b>	<b>0</b>	<b>0</b>	<b>1</b>	<b>1</b>	<b>0</b>	<b>0</b>	<b>0</b>	<b>0x30</b>
GND	SCL	SDA	0	0	1	1	0	0	1	0x32
GND	SDA	SCL	0	0	1	1	0	1	0	0x34
GND	SDA	SDA	0	0	1	1	0	1	1	0x36
V <sup>+</sup>	SCL	SCL	0	0	1	1	1	0	0	0x38
V <sup>+</sup>	SCL	SDA	0	0	1	1	1	0	1	0x3A
V <sup>+</sup>	SDA	SCL	0	0	1	1	1	1	0	0x3C
V <sup>+</sup>	SDA	SDA	0	0	1	1	1	1	1	0x3E
<b>GND</b>	<b>GND</b>	<b>GND</b>	<b>0</b>	<b>1</b>	<b>0</b>	<b>0</b>	<b>0</b>	<b>0</b>	<b>0</b>	<b>0x40</b>
GND	GND	V <sup>+</sup>	0	1	0	0	0	0	1	0x42
GND	V <sup>+</sup>	GND	0	1	0	0	0	1	0	0x44
GND	V <sup>+</sup>	V <sup>+</sup>	0	1	0	0	0	1	1	0x46
V <sup>+</sup>	GND	GND	0	1	0	0	1	0	0	0x48
V <sup>+</sup>	GND	V <sup>+</sup>	0	1	0	0	1	0	1	0x4A
V <sup>+</sup>	V <sup>+</sup>	GND	0	1	0	0	1	1	0	0x4C
V <sup>+</sup>	V <sup>+</sup>	V <sup>+</sup>	0	1	0	0	1	1	1	0x4E
<b>GND</b>	<b>GND</b>	<b>SCL</b>	<b>0</b>	<b>1</b>	<b>0</b>	<b>1</b>	<b>0</b>	<b>0</b>	<b>0</b>	<b>0x50</b>
GND	GND	SDA	0	1	0	1	0	0	1	0x52
GND	V <sup>+</sup>	SCL	0	1	0	1	0	1	0	0x54
GND	V <sup>+</sup>	SDA	0	1	0	1	0	1	1	0x56
V <sup>+</sup>	GND	SCL	0	1	0	1	1	0	0	0x58
V <sup>+</sup>	GND	SDA	0	1	0	1	1	0	1	0x5A
V <sup>+</sup>	V <sup>+</sup>	SCL	0	1	0	1	1	1	0	0x5C
V <sup>+</sup>	V <sup>+</sup>	SDA	0	1	0	1	1	1	1	0x5E

# 2-Wire-Interfaced 16-Bit I/O Port Expander with Interrupt and Hot-Insertion Protection

MAX7311

Table 7. MAX7311 Address Map (continued)

AD2	AD1	AD0	A6	A5	A4	A3	A2	A1	A0	ADDRESS (HEX)
<b>SCL</b>	<b>SCL</b>	<b>GND</b>	<b>1</b>	<b>0</b>	<b>1</b>	<b>0</b>	<b>0</b>	<b>0</b>	<b>0</b>	<b>0xA0</b>
SCL	SCL	V*	1	0	1	0	0	0	1	0xA2
SCL	SDA	GND	1	0	1	0	0	1	0	0xA4
SCL	SDA	V*	1	0	1	0	0	1	1	0xA6
SDA	SCL	GND	1	0	1	0	1	0	0	0xA8
SDA	SCL	V*	1	0	1	0	1	0	1	0xAA
SDA	SDA	GND	1	0	1	0	1	1	0	0xAC
SDA	SDA	V*	1	0	1	0	1	1	1	0xAE
<b>SCL</b>	<b>SCL</b>	<b>SCL</b>	<b>1</b>	<b>0</b>	<b>1</b>	<b>1</b>	<b>0</b>	<b>0</b>	<b>0</b>	<b>0xB0</b>
SCL	SCL	SDA	1	0	1	1	0	0	1	0xB2
SCL	SDA	SCL	1	0	1	1	0	1	0	0xB4
SCL	SDA	SDA	1	0	1	1	0	1	1	0xB6
SDA	SCL	SCL	1	0	1	1	1	0	0	0xB8
SDA	SCL	SDA	1	0	1	1	1	0	1	0xBA
SDA	SDA	SCL	1	0	1	1	1	1	0	0xBC
SDA	SDA	SDA	1	0	1	1	1	1	1	0xBE
<b>SCL</b>	<b>GND</b>	<b>GND</b>	<b>1</b>	<b>1</b>	<b>0</b>	<b>0</b>	<b>0</b>	<b>0</b>	<b>0</b>	<b>0xC0</b>
SCL	GND	V*	1	1	0	0	0	0	1	0xC2
SCL	V*	GND	1	1	0	0	0	1	0	0xC4
SCL	V*	V*	1	1	0	0	0	1	1	0xC6
SDA	GND	GND	1	1	0	0	1	0	0	0xC8
SDA	GND	V*	1	1	0	0	1	0	1	0xCA
SDA	V*	GND	1	1	0	0	1	1	0	0xCC
SDA	V*	V*	1	1	0	0	1	1	1	0xCE
<b>SCL</b>	<b>GND</b>	<b>SCL</b>	<b>1</b>	<b>1</b>	<b>0</b>	<b>1</b>	<b>0</b>	<b>0</b>	<b>0</b>	<b>0xD0</b>
SCL	GND	SDA	1	1	0	1	0	0	1	0xD2
SCL	V*	SCL	1	1	0	1	0	1	0	0xD4
SCL	V*	SDA	1	1	0	1	0	1	1	0xD6
SDA	GND	SCL	1	1	0	1	1	<b>0</b>	<b>0</b>	0xD8
SDA	GND	SDA	1	1	0	1	1	0	1	0xDA
SDA	V*	SCL	1	1	0	1	1	1	0	0xDC
SDA	V*	SDA	1	1	0	1	1	1	1	0xDE

## Chip Information

TRANSISTOR COUNT: 12,994

PROCESS: BiCMOS

# 2-Wire-Interfaced 16-Bit I/O Port Expander with Interrupt and Hot-Insertion Protection

## Package Information

(The package drawing(s) in this data sheet may not reflect the most current specifications. For the latest package outline information, go to [www.maxim-ic.com/packages](http://www.maxim-ic.com/packages).)



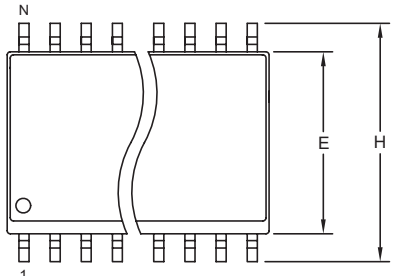

**TOP VIEW**

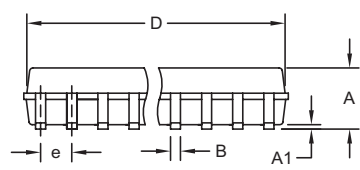

**FRONT VIEW**

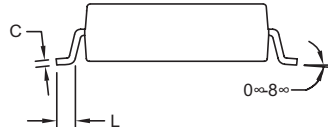

**SIDE VIEW**

DIM	INCHES		MILLIMETERS	
	MIN	MAX	MIN	MAX
A	0.093	0.104	2.35	2.65
A1	0.004	0.012	0.10	0.30
B	0.014	0.019	0.35	0.49
C	0.009	0.013	0.23	0.32
e	0.050		1.27	
E	0.291	0.299	7.40	7.60
H	0.394	0.419	10.00	10.65
L	0.016	0.050	0.40	1.27

VARIATIONS:

DIM	INCHES		MILLIMETERS		N	MS013
	MIN	MAX	MIN	MAX		
D	0.398	0.413	10.10	10.50	16	AA
D	0.447	0.463	11.35	11.75	18	AB
D	0.496	0.512	12.60	13.00	20	AC
D	0.598	0.614	15.20	15.60	24	AD
D	0.697	0.713	17.70	18.10	28	AE

**NOTES:**

1. D&E DO NOT INCLUDE MOLD FLASH.
2. MOLD FLASH OR PROTRUSIONS NOT TO EXCEED 0.15mm (.006").
3. LEADS TO BE COPLANAR WITHIN 0.10mm (.004").
4. CONTROLLING DIMENSION: MILLIMETERS.
5. MEETS JEDEC MS013.
6. N = NUMBER OF PINS.

<b>DALLAS SEMICONDUCTOR</b>		<b>MAXIM</b>	
<small>PROPRIETARY INFORMATION</small>			
<small>TITLE:</small>			
<b>PACKAGE OUTLINE, .300" SOIC</b>			
<small>APPROVAL</small>	<small>DOCUMENT CONTROL NO.</small>	<small>REV.</small>	<small>1/1</small>
	21-0042	B	

# 2-Wire-Interfaced 16-Bit I/O Port Expander with Interrupt and Hot-Insertion Protection

## Package Information (continued)

(The package drawing(s) in this data sheet may not reflect the most current specifications. For the latest package outline information, go to [www.maxim-ic.com/packages](http://www.maxim-ic.com/packages).)

MAX7311

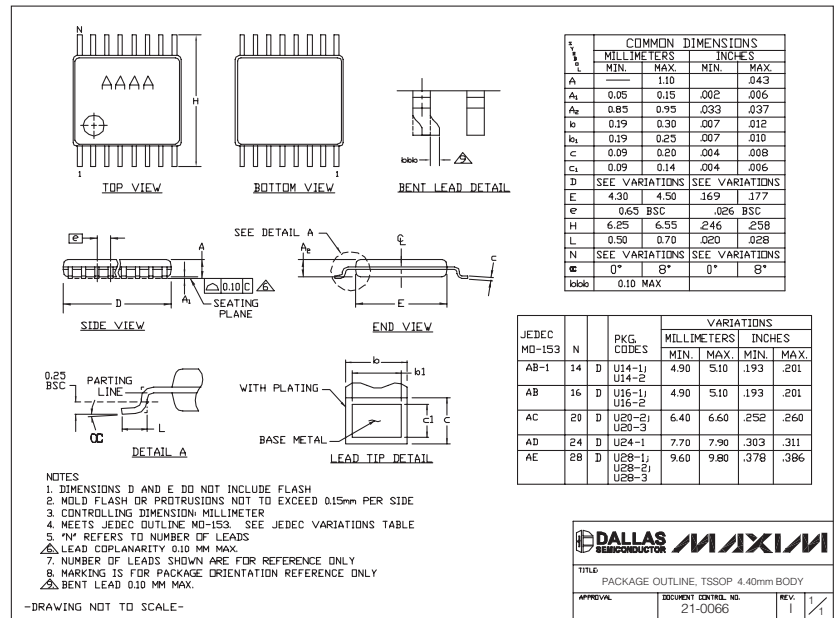
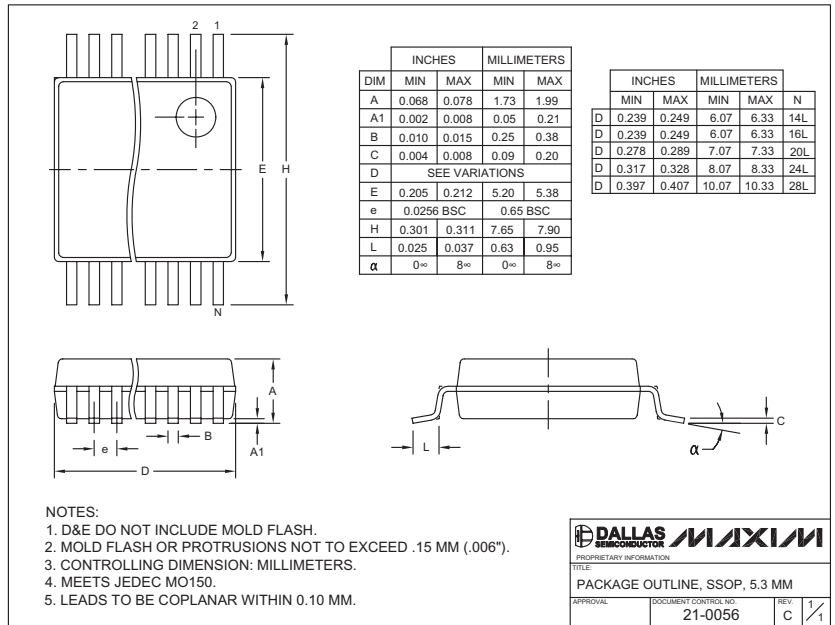

# 2-Wire-Interfaced 16-Bit I/O Port Expander with Interrupt and Hot-Insertion Protection

## Package Information (continued)

(The package drawing(s) in this data sheet may not reflect the most current specifications. For the latest package outline information, go to [www.maxim-ic.com/packages](http://www.maxim-ic.com/packages).)

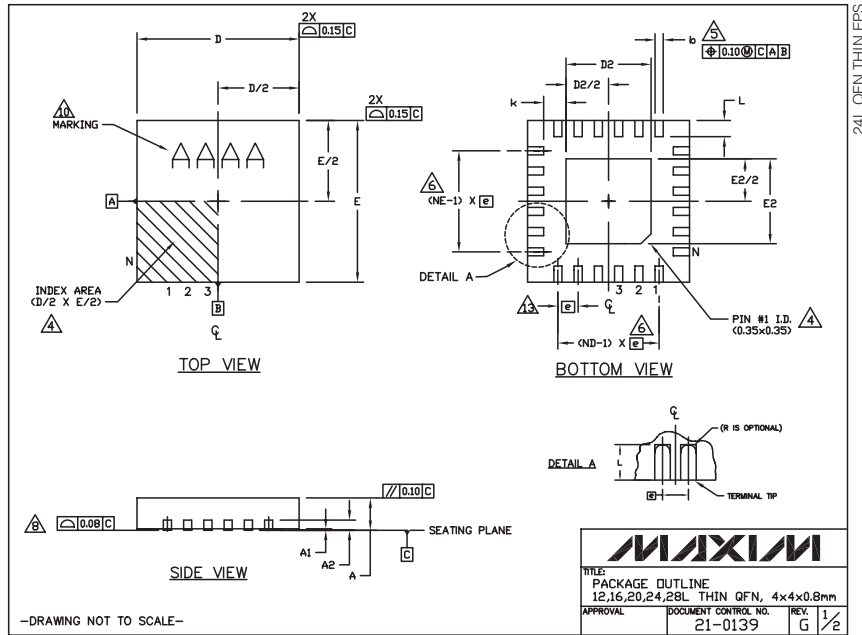

COMMON DIMENSIONS																		
PKG REF.	12L 4x4			16L 4x4			20L 4x4			24L 4x4			28L 4x4					
	MIN.	NOM.	MAX.	MIN.	NOM.	MAX.	MIN.	NOM.	MAX.	MIN.	NOM.	MAX.	MIN.	NOM.	MAX.			
A	0.70	0.75	0.80	0.70	0.75	0.80	0.70	0.75	0.80	0.70	0.75	0.80	0.70	0.75	0.80			
A1	0.0	0.02	0.05	0.0	0.02	0.05	0.0	0.02	0.05	0.0	0.02	0.05	0.0	0.02	0.05			
A2	0.20 REF.						0.20 REF.						0.20 REF.					
b	0.25	0.30	0.35	0.25	0.30	0.35	0.25	0.25	0.30	0.10	0.23	0.30	0.15	0.20	0.25			
D	3.90	4.00	4.10	3.90	4.00	4.10	3.90	4.00	4.10	3.90	4.00	4.10	3.90	4.00	4.10			
E	3.90	4.00	4.10	3.90	4.00	4.10	3.90	4.00	4.10	3.90	4.00	4.10	3.90	4.00	4.10			
e	0.80 BSC.			0.65 BSC.			0.50 BSC.			0.50 BSC.			0.40 BSC.					
k	0.25	-	-	0.25	-	-	0.25	-	-	0.25	-	-	0.25	-	-			
L	0.45	0.55	0.65	0.45	0.55	0.65	0.45	0.55	0.65	0.30	0.40	0.50	0.30	0.40	0.50			
N	12			16			20			24			28					
ND	3			4			5			6			7					
NE	3			4			5			6			7					
VARDEC VPG	VGGB			VGGC			VGGD-1			VGGD-2			VGGE					

EXPOSED PAD VARIATIONS									
PKG CODES	D2			E2					
	MIN.	NOM.	MAX.	MIN.	NOM.	MAX.			
T1244-3	1.95	2.10	2.25	1.95	2.10	2.25			
T1244-4	1.95	2.10	2.25	1.95	2.10	2.25			
T1644-3	1.95	2.10	2.25	1.95	2.10	2.25			
T1644-4	1.95	2.10	2.25	1.95	2.10	2.25			
T2044-2	1.95	2.10	2.25	1.95	2.10	2.25			
T2044-3	1.95	2.10	2.25	1.95	2.10	2.25			
T2444-2	1.95	2.10	2.25	1.95	2.10	2.25			
T2444-3	2.45	2.60	2.63	2.45	2.60	2.63			
T2444-4	2.45	2.60	2.63	2.45	2.60	2.63			
T2844-1	2.50	2.60	2.70	2.50	2.60	2.70			

NOTES:  
 1. DIMENSIONING & TOLERANCING CONFORM TO ASME Y14.5M-1994.  
 2. ALL DIMENSIONS ARE IN MILLIMETERS, ANGLES ARE IN DEGREES.  
 3. N IS THE TOTAL NUMBER OF TERMINALS.  
 4. THE TERMINAL #1 IDENTIFIER AND TERMINAL NUMBERING CONVENTION SHALL CONFORM TO JEDEC 95-1 SPP-012. DETAILS OF TERMINAL #1 IDENTIFIER ARE OPTIONAL, BUT MUST BE LOCATED WITHIN THE ZONE INDICATED. THE TERMINAL #1 IDENTIFIER MAY BE EITHER A MOLD OR MARKED FEATURE.  
 5. DIMENSION b APPLIES TO METALLIZED TERMINAL AND IS MEASURED BETWEEN 0.25mm AND 0.30mm FROM TERMINAL TIP.  
 6. ND AND NE REFER TO THE NUMBER OF TERMINALS ON EACH D AND E SIDE RESPECTIVELY.  
 7. DEPOPULATION IS POSSIBLE IN A SYMMETRICAL FASHION.  
 8. COPLANARITY APPLIES TO THE EXPOSED HEAT SINK SLUG AS WELL AS THE TERMINALS.  
 9. DRAWING CONFORMS TO JEDEC MO220, EXCEPT FOR T2444-3, T2444-4 AND T2844-1.  
 10. MARKING IS FOR PACKAGE ORIENTATION REFERENCE ONLY.  
 11. COPLANARITY SHALL NOT EXCEED 0.08mm.  
 12. VARPAGE SHALL NOT EXCEED 0.10mm.  
 13. LEAD CENTERLINES TO BE AT TRUE POSITION AS DEFINED BY BASIC DIMENSION 'e', ±0.05.  
 14. NUMBER OF LEADS SHOWN ARE FOR REFERENCE ONLY.  
 15. ALL DIMENSIONS ARE THE SAME FOR LEADED (←) & PIFREE (→) PACKAGE CODES.

MAXIM  
 TITLE: PACKAGE OUTLINE  
 12,16,20,24,28L THIN QFN, 4x4x0.8mm  
 APPROVAL: DOCUMENT CONTROL NO. 21-0139 REV. G 1/2

-DRAWING NOT TO SCALE-

Maxim cannot assume responsibility for use of any circuitry other than circuitry entirely embodied in a Maxim product. No circuit patent licenses are implied. Maxim reserves the right to change the circuitry and specifications without notice at any time.

Maxim Integrated Products, 120 San Gabriel Drive, Sunnyvale, CA 94086 408-737-7600 16

© 2005 Maxim Integrated Products Printed USA MAXIM is a registered trademark of Maxim Integrated Products, Inc.