

LOC	DIST	REVISIONS					
E	B	P	LTR	DESCRIPTION	DATE	DWN	APVD
			BA1	AS PER ECR-09-006166	17-MAR-09	SM	JC

FOR FURTHER INFORMATION SEE DATA SHEET FOR
CPF SERIES-THIN FILM PRECISION CHIP RESISTORS

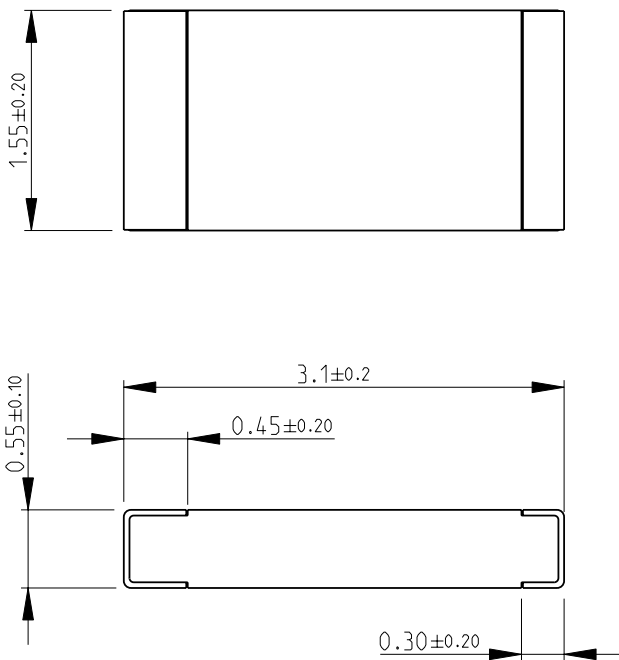

RoHS Compliant

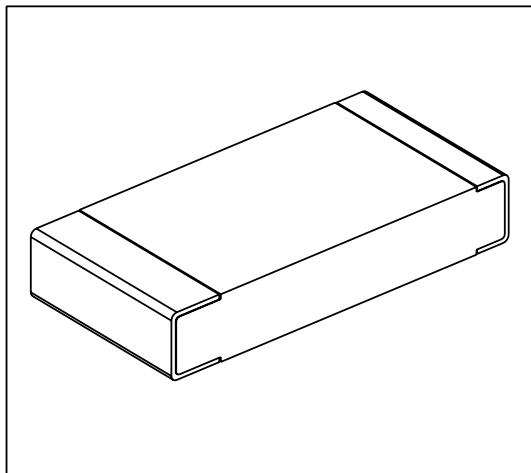

2008

RELEASED FOR PUBLICATION

THIS DRAWING IS UNPUBLISHED.

© COPYRIGHT 2008 BY TYCO ELECTRONICS CORPORATION. ALL RIGHTS RESERVED.

DIMENSIONS: mm	DWN	SUBHASH.M	22-Sep-08	MATERIAL	-	FINISH	-						
	CHK	PRAKASH.S	22-Sep-08	Tyco Electronics Corporation Dorcan, Swindon, SN3 5HH									
TOLERANCES UNLESS OTHERWISE SPECIFIED:	APVD	STEPHEN.P	22-Sep-08					NAME	THIN FILM PRECISION CHIP RESISTORS SERIES CPF 1206				
	PRODUCT SPEC	-	-	SIZE	CAGE CODE	DRAWING NO	RESTRICTED TO						
	APPLICATION SPEC	-	-	A 4	00779	©= 1614722	-						
0 PLC ±0.2 1 PLC ±0.1 2 PLC ± 3 PLC ± 4 PLC ± ANGLES ±5°	WEIGHT	-	-	CUSTOMER DRAWING		SCALE	20:1	SHEET	1	OF	1	REV	BA1