

SKiIP 39AHB16V1

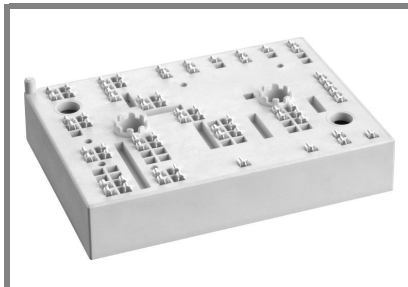

MiniSKiIP[®] 3

3-phase bridge rectifier +
brake chopper

SKiIP 39AHB16V1

Features

- Fast Trench IGBTs
- Robust and soft freewheeling diodes in CAL technology
- Highly reliable spring contacts for electrical connections
- UL recognised file no. E63532

Typical Applications*

- Input bridge for inverter up to 45 kVA

Remarks

- V_{CEsat} , V_F = chip level value

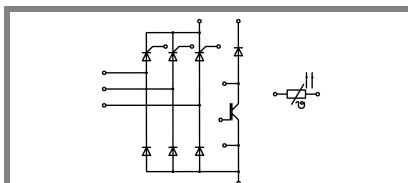

AHB

Absolute Maximum Ratings		$T_s = 25^\circ\text{C}$, unless otherwise specified	
Symbol	Conditions	Values	Units
IGBT - Chopper			
V_{CES}		1200	V
I_C	$T_s = 25 (70)^\circ\text{C}$	157 (118)	A
I_{CRM}	$t_p \leq 1 \text{ ms}$	280	A
V_{GES}		± 20	V
T_j		- 40 ... + 150	$^\circ\text{C}$
Diode - Chopper			
I_F	$T_s = 25 (70)^\circ\text{C}$	167 (124)	A
I_{FRM}	$t_p \leq 1 \text{ ms}$	280	A
T_j		- 40 ... + 150	$^\circ\text{C}$
Diode / Thyristor - Rectifier			
V_{RRM}		1600	V
I_F / I_T	$T_s = 70$	121	A
I_{FSM} / I_{TSM}	$t_p = 10 \text{ ms}$, $\sin 180^\circ$, $T_j = 25^\circ\text{C}$	1250	A
i^2t	$t_p = 10 \text{ ms}$, $\sin 180^\circ$, $T_j = 25^\circ\text{C}$	7800	A^2s
T_j	Diode	- 40 ... + 150	$^\circ\text{C}$
T_j	Thyristor	- 40 ... + 125	$^\circ\text{C}$
I_{IRMS}	per power terminal (20 A / spring)	160	A
T_{stg}	$T_{op} \leq T_{stg}$	- 40 ... + 125	$^\circ\text{C}$
V_{isol}	AC, 1 min.	2500	V

Characteristics		$T_s = 25^\circ\text{C}$, unless otherwise specified			
Symbol	Conditions	min.	typ.	max.	Units
IGBT - Chopper					
V_{CEsat}	$I_{Cnom} = 140 \text{ A}$, $T_j = 25 (125)^\circ\text{C}$		1,7 (2)	2,1 (2,4)	V
$V_{GE(th)}$	$V_{GE} = V_{CE}$, $I_C = 6 \text{ mA}$	5	5,8	6,5	V
$V_{CE(TO)}$	$T_j = 25 (125)^\circ\text{C}$		1 (0,9)	1,2 (1,1)	V
r_T	$T_j = 25 (125)^\circ\text{C}$		5 (7,9)	6,4 (9,3)	m Ω
C_{ies}	$V_{CE} = 25 \text{ V}$, $V_{GE} = 0 \text{ V}$, $f = 1 \text{ MHz}$		11,2		nF
C_{oes}	$V_{CE} = 25 \text{ V}$, $V_{GE} = 0 \text{ V}$, $f = 1 \text{ MHz}$		1,9		nF
C_{res}	$V_{CE} = 25 \text{ V}$, $V_{GE} = 0 \text{ V}$, $f = 1 \text{ MHz}$		1,5		nF
$R_{th(j-s)}$	per IGBT		0,3		K/W
$t_{d(on)}$	under following conditions		80		ns
t_r	$V_{CC} = 600 \text{ V}$, $V_{GE} = \pm 15 \text{ V}$		40		ns
$t_{d(off)}$	$I_{Cnom} = 140 \text{ A}$, $T_j = 125^\circ\text{C}$		500		ns
t_f	$R_{Gon} = R_{Goff} = 5 \Omega$		100		ns
E_{on}	inductive load		19,9		mJ
E_{off}			17,3		mJ
Diode - Chopper					
$V_F = V_{EC}$	$I_{Fnom} = 140 \text{ A}$, $T_j = 25 (125)^\circ\text{C}$		1,5 (1,5)	1,7 (1,7)	V
$V_{(TO)}$	$T_j = 25 (125)^\circ\text{C}$		1 (0,8)	1,1 (0,9)	V
r_T	$T_j = 25 (125)^\circ\text{C}$		3,6 (5)	4,3 (5,7)	m Ω
$R_{th(j-s)}$	per diode		0,4		K/W
I_{RRM}	under following conditions		210		A
Q_{rr}	$I_{Fnom} = 140 \text{ A}$, $V_R = 600 \text{ V}$		38		μC
E_{rr}	$V_{GE} = 0 \text{ V}$, $T_j = 125^\circ\text{C}$		16,2		mJ
	$di_F/dt = 4300 \text{ A}/\mu\text{s}$				

Characteristics		$T_s = 25\text{ °C}$, unless otherwise specified			
Symbol	Conditions	min.	typ.	max.	Units
Diode - Rectifier					
V_F	$I_{Fnom} = 90\text{ A}$, $T_j = 25\text{ °C}$		1,2		V
$V_{(TO)}$	$T_j = 150\text{ °C}$		0,8		V
r_T	$T_j = 150\text{ °C}$		4		mΩ
$R_{th(j-s)}$	per diode		0,5		K/W
Thyristor - Rectifier					
V_T	$I_{Fnom} = 200\text{ A}$, $T_j = 25\text{ (125) °C}$			1,65 (1,6)	V
$V_{T(TO)}$	$T_j = 125\text{ °C}$			0,9	V
r_T	$T_j = 125\text{ °C}$			3,5	mΩ
V_{GT}	$T_j = 25\text{ °C}$			3	V
I_{GT}	$T_j = 25\text{ °C}$	150			mA
I_H	$T_j = 25\text{ °C}$		150		mA
I_L	$T_j = 25\text{ °C}$		300		mA
$dv/dt_{(cr)}$	$T_j = 125\text{ °C}$			1000	V/μs
$di/dt_{(cr)}$	$T_j = 125\text{ °C}$			100	A/μs
$R_{th(j-s)}$	per thyristor		0,5		K/W
Temperature Sensor					
R_{ts}	3 %, $T_r = 25\text{ (100) °C}$		1000(1670)		Ω
Mechanical Data					
w			95		g
M_s	Mounting torque	2		2,5	Nm

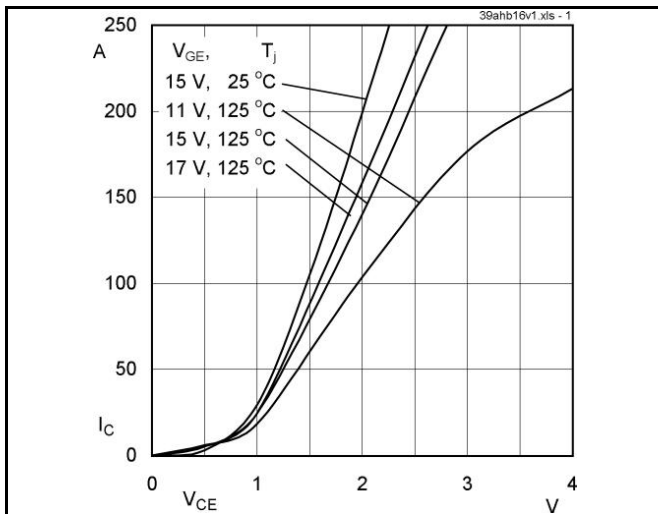

Fig. 1 Typ. output characteristic

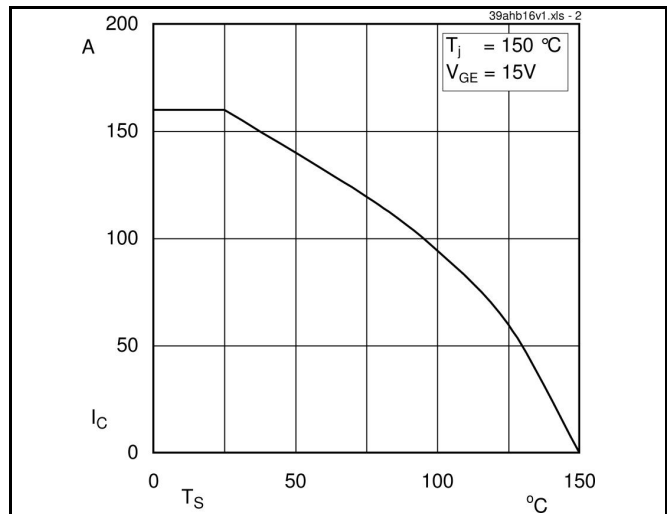

Fig. 2 Typ. rated current vs. temperature

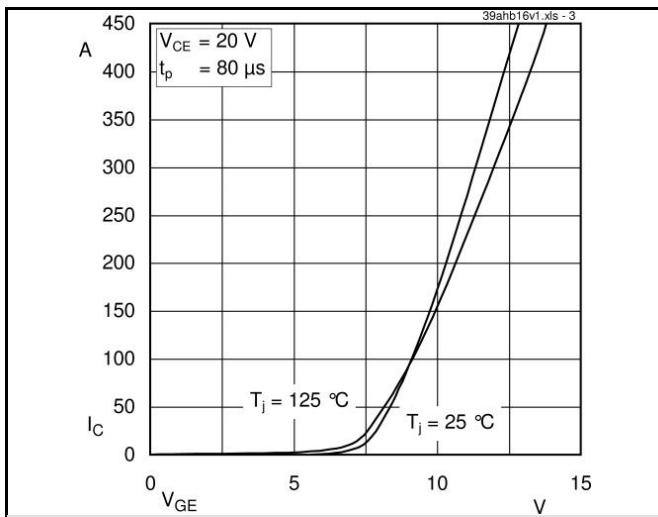

Fig. 3 Typ. transfer characteristic

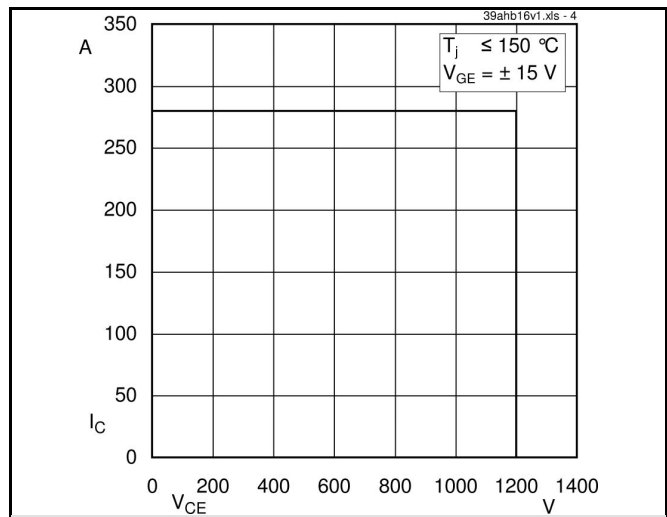

Fig. 4 Reverse bias safe operating area

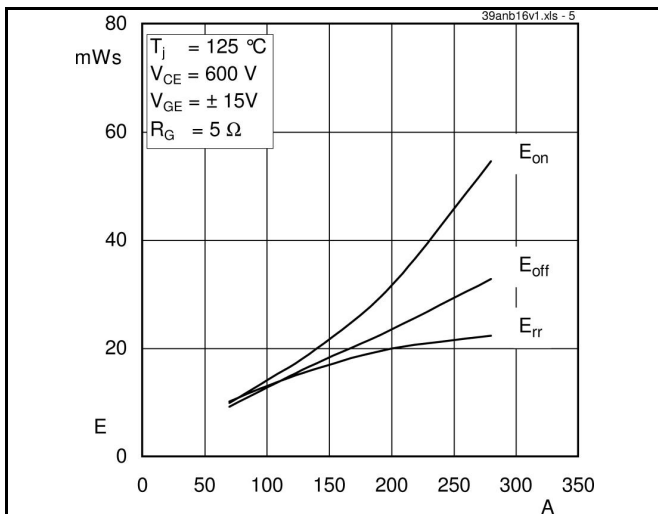

Fig. 5 Typ. Turn-on /-off energy = $f(I_C)$

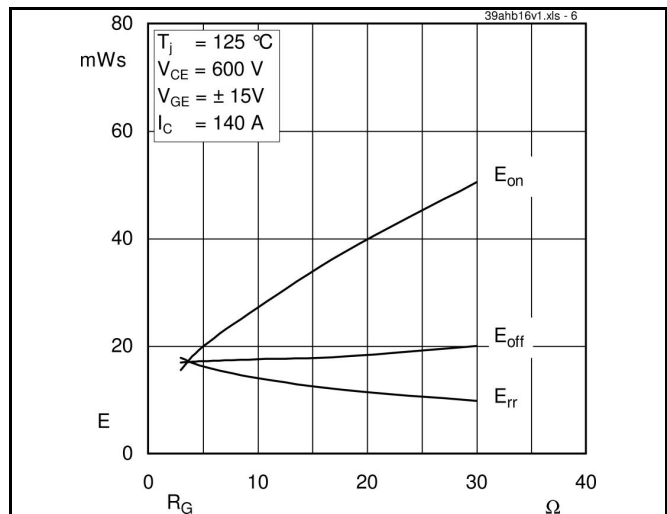

Fig. 6 Typ. Turn-on /-off energy = $f(R_G)$

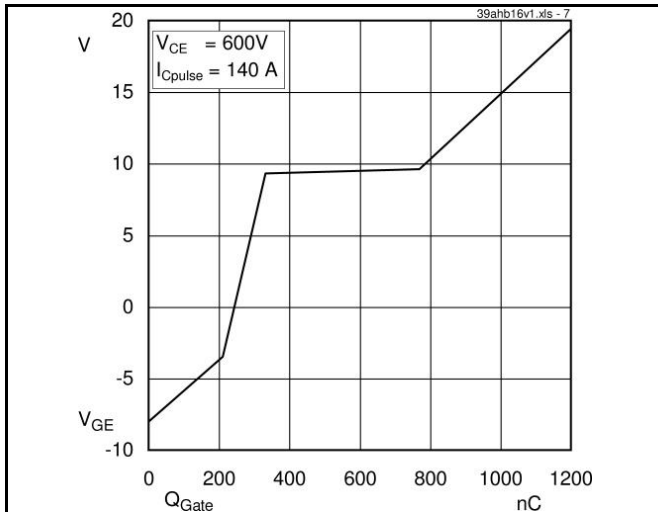

Fig. 7 Typ. gate charge characteristic

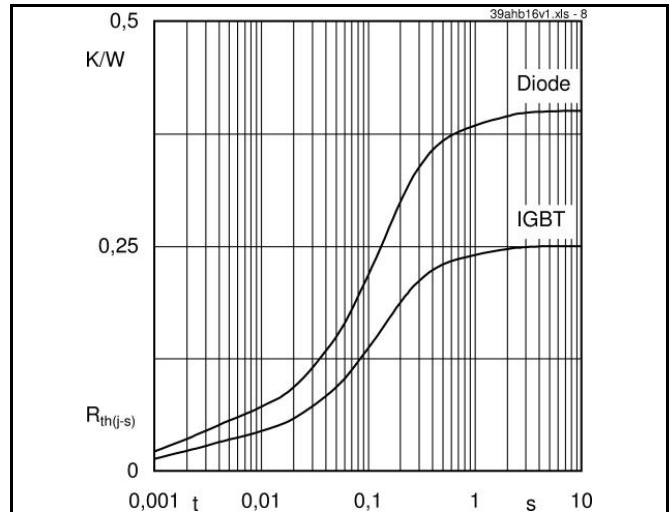

Fig. 8 Typ. thermal impedance

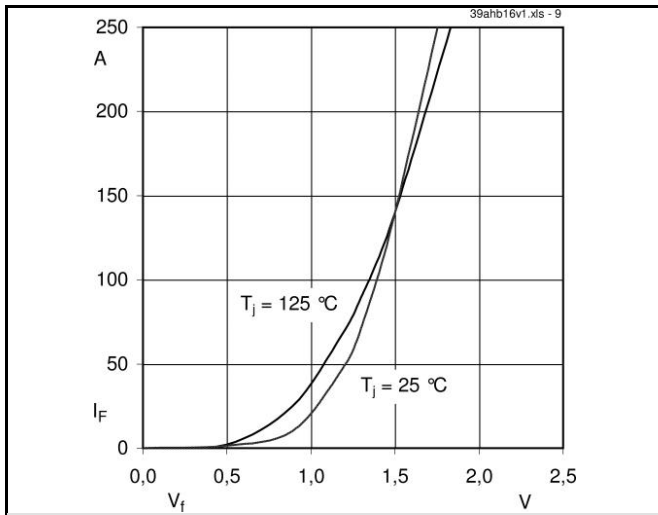

Fig. 9 Typ. freewheeling diode forward characteristic

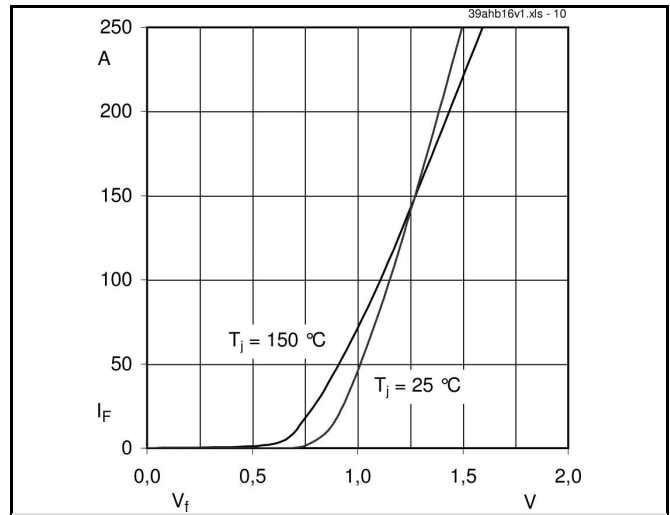

Fig. 10 Typ. input bridge forward characteristic

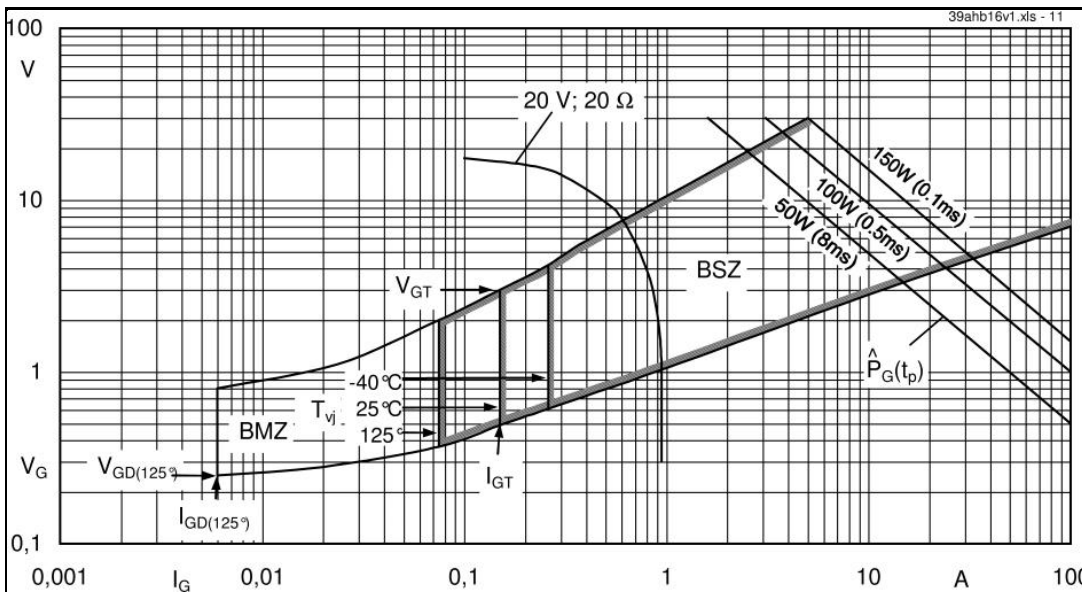
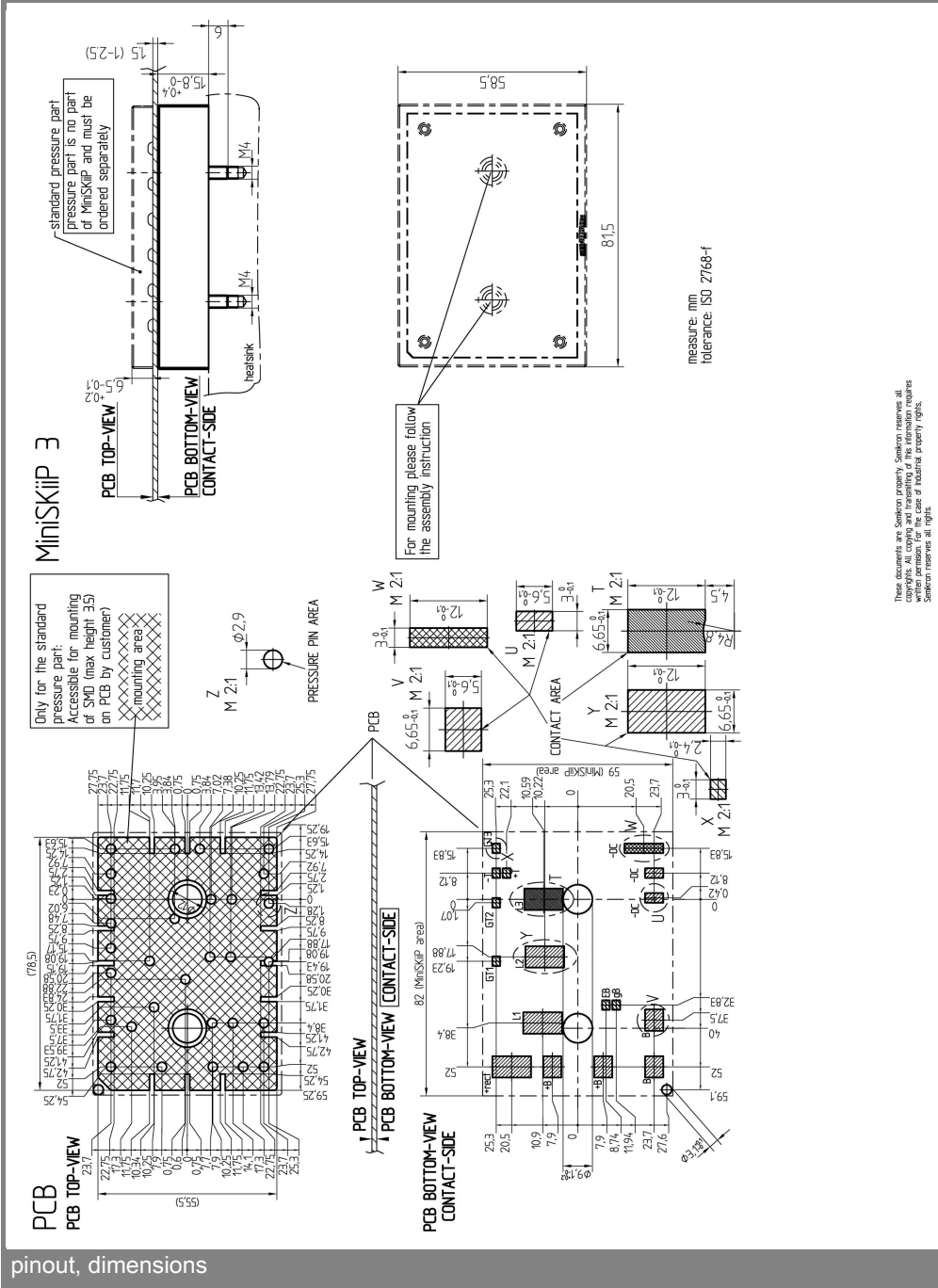
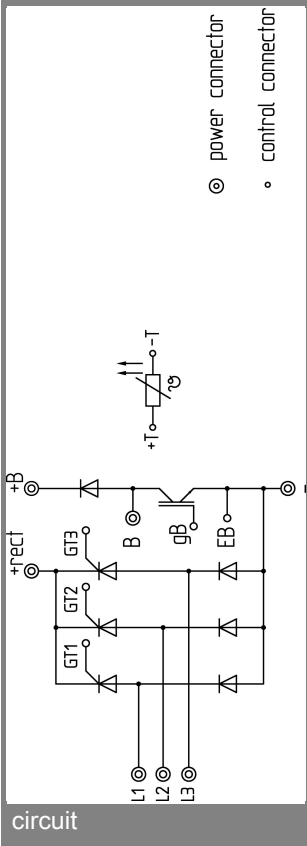

Fig. 11 Typ. gate trigger characteristic

SKiiP 39AHB16V1



This is an electrostatic discharge sensitive device (ESDS), international standard IEC 60747-1, Chapter IX.

* The specifications of our components may not be considered as an assurance of component characteristics. Components have to be tested for the respective application. Adjustments may be necessary. The use of SEMIKRON products in life support appliances and systems is subject to prior specification and written approval by SEMIKRON. We therefore strongly recommend prior consultation of our personal.