

SKD 62



SEMIPONT® 3

Power Bridge Rectifiers

SKD 62

Features

- Robust plastic case with screw terminals
- Large, isolated base plate
- Blocking voltage up to 1800 V
- High surge currents
- Three phase bridge rectifier
- Easy chassis mounting
- UL recognized, file no. E 63 532

Typical Applications*

- Three phase rectifiers for power supplies
- Input rectifiers for variable frequency drives
- Rectifiers for DC motor field supplies
- Battery charger rectifiers

- 1) Freely suspended or mounted on an insulator
- 2) Mounted on a painted metal sheet of min. 250 x 250 x 1 mm;
 $R_{th(s-a)} = 1,8 \text{ K/W}$
- 3) Available in limited quantities

V_{RSM} V	V_{RRM}, V_{DRM} V	$I_D = 60 \text{ A}$ (full conduction) ($T_c = 110 \text{ °C}$)
400	400	SKD 62/04
800	800	SKD 62/08
1200	1200	SKD 62/12
1400	1400	SKD 62/14
1600	1600	SKD 62/16
1800	1800	SKD 62/18 ³⁾

Symbol	Conditions	Values	Units
I_D	$T_c = 85 \text{ °C}$ resistive / inductive load	86	A
	$T_a = 45 \text{ °C}$; isolated ¹⁾	10,5	A
	$T_a = 45 \text{ °C}$; chassis ²⁾	24	A
	$T_a = 45 \text{ °C}$; P1A/120 (P 1A/200)	46 (53)	A
I_{FSM}	$T_{vj} = 25 \text{ °C}$; 10 ms	500	A
	$T_{vj} = 150 \text{ °C}$; 10 ms	425	A
i^2t	$T_{vj} = 25 \text{ °C}$; 8,3 ... 10 ms ms	1250	A ² s
	$T_{vj} = 150 \text{ °C}$; 8,3 ... 10 ms ms	900	A ² s
V_F	$T_{vj} = 25 \text{ °C}$; $I_F = 150 \text{ A}$	max. 1,8	V
$V_{(TO)}$	$T_{vj} = 150 \text{ °C}$	max. 0,85	V
r_T	$T_{vj} = 150 \text{ °C}$	max. 8	mΩ
I_{RD}	$T_{vj} = 25 \text{ °C}$; $V_{DD} = V_{DRM}$; $V_{RD} = V_{RRM}$	max. 0,5	mA
	$T_{vj} = 150 \text{ °C}$; $V_{RD} = V_{RRM}$	5	mA
$R_{th(j-c)}$	per diode	1,5	K/W
	total	0,25	K/W
$R_{th(c-s)}$		0,07	K/W
	T_{vj}	-40 ... + 150	°C
	T_{stg}	-40 ... + 125	°C
V_{isol}	a. c. 50 Hz; r.m.s.; 1 s / 1 min.	3600 (3000)	V
M_s	to heatsink	5 ± 15%	Nm
M_t	to terminals	5 ± 15%	Nm
m		165	g
Case		G 36	

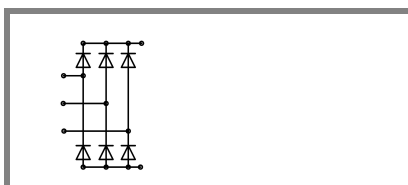

SKD

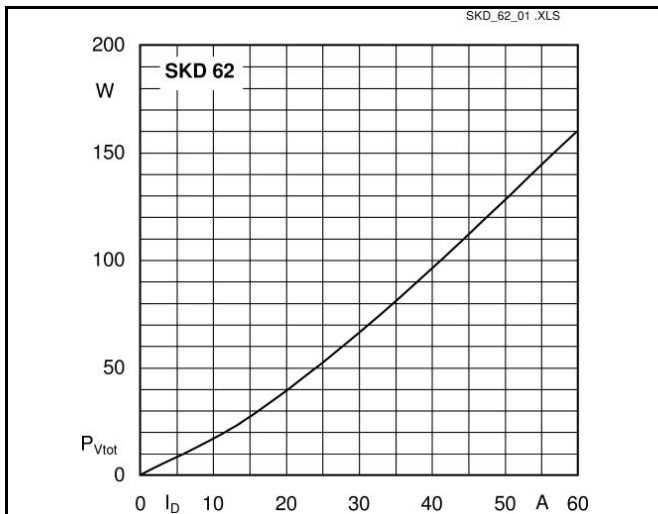

Fig. 3L Power dissipation vs. output current

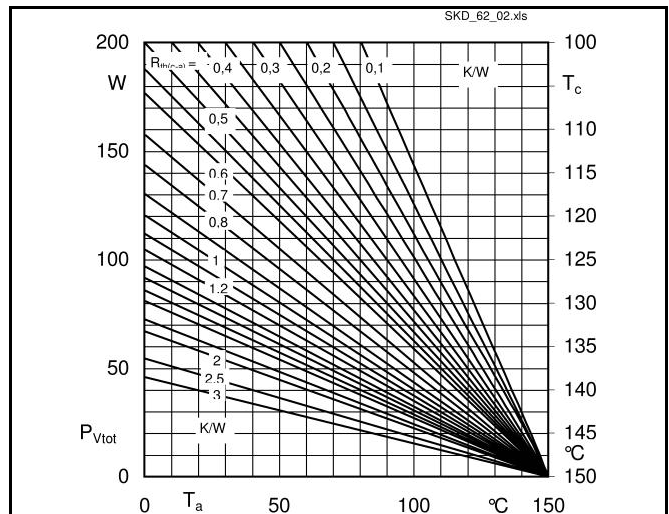

Fig. 3R Power dissipation vs. case temperature

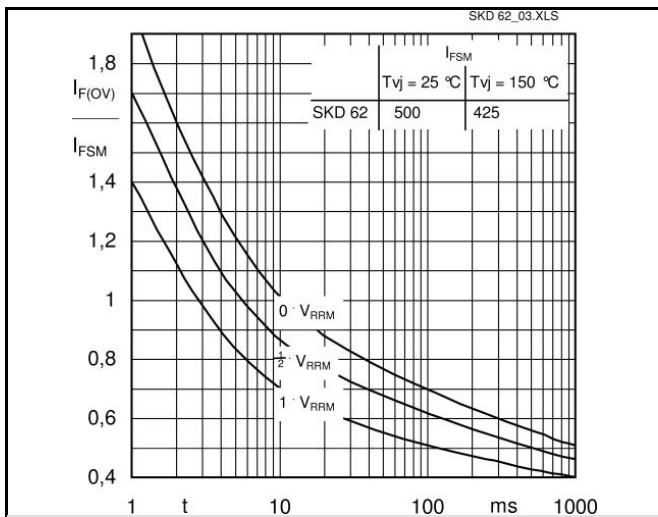

Fig. 6 Surge overload characteristics vs. time

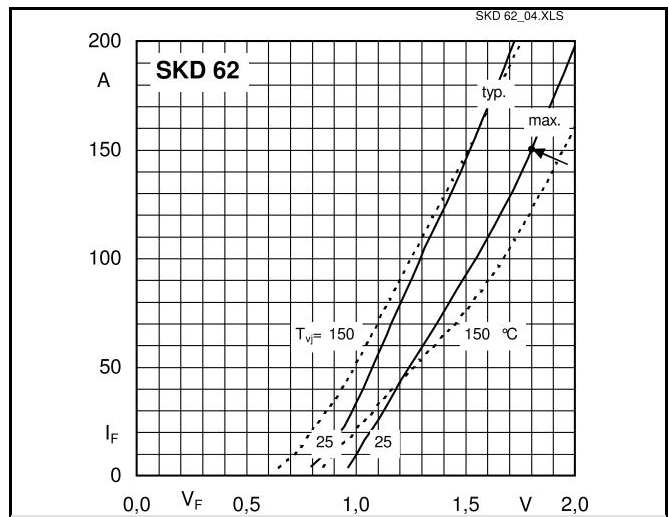

Fig. 9 Forward characteristics of a diode arm

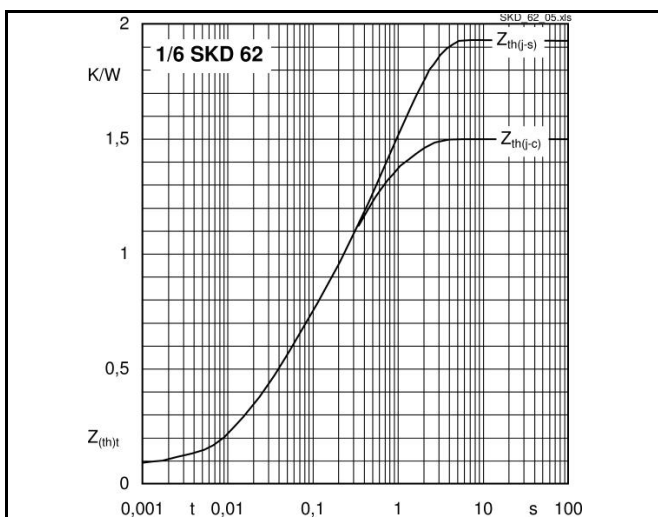
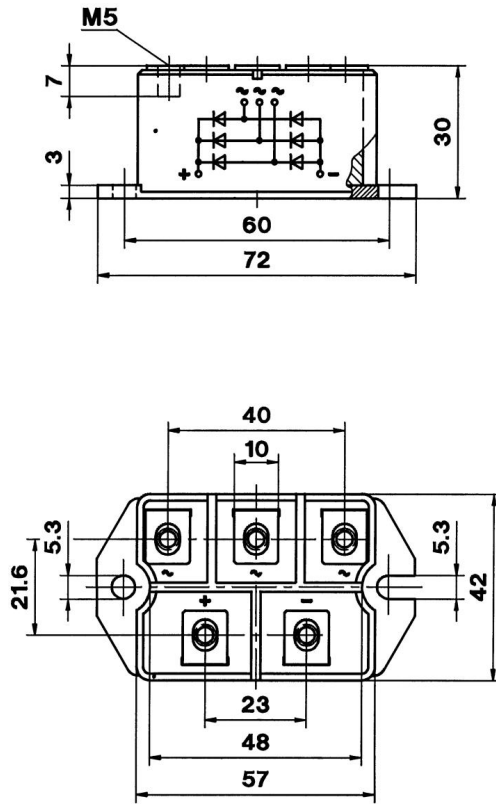

Fig. 12 Transient thermal impedance vs. time

Dimensions in mm



Case G 36

* The specifications of our components may not be considered as an assurance of component characteristics. Components have to be tested for the respective application. Adjustments may be necessary. The use of SEMIKRON products in life support appliances and systems is subject to prior specification and written approval by SEMIKRON. We therefore strongly recommend prior consultation of our personal.