

# SKDH 145

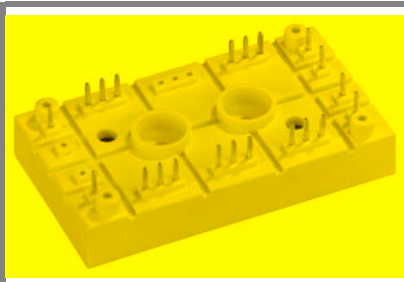

**SEMIPONT™ 5**

## Half Controlled 3-phase Bridge Rectifier

### SKDH 145

#### Target Data

#### Features

- Compact design
- Two screws mounting
- Heat transfer and isolation through direct copper board (low  $R_{th}$ )
- Low resistance in steady-state and high reliability
- High surge currents
- UL -recognized, file no. E 63 532

#### Typical Applications\*

- For DC drives with a fixed direction of rotation
- Controlled field rectifier for DC motors
- Controlled battery charger

$V_{RSM}$ V	$V_{RRM}, V_{DRM}$ V	$I_D = 140$ A (full conduction) ( $T_s = 80$ °C)
1300	1200	SKDH 145/12
1700	1600	SKDH 145/16

Symbol	Conditions	Values	Units
$I_D$	$T_s = 80$ °C	110	A
$I_{TSM}, I_{FSM}$	$T_{vj} = 25$ °C; 10 ms	1350	A
	$T_{vj} = 125$ °C; 10 ms	1250	A
$i^2t$	$T_{vj} = 25$ °C; 8,3 ... 10 ms	9100	A <sup>2</sup> s
	$T_{vj} = 125$ °C; 8,3 ... 10 ms	7800	A <sup>2</sup> s
$V_T, V_F$	$T_{vj} = 25$ °C; $I_T, I_F = 150$ A	max. 1,6	V
$V_{T(TO)} / V_{F(TO)}$	$T_{vj} = 125$ °C;	max. 0,9	V
$r_T$	$T_{vj} = 125$ °C	max. 5	mΩ
$I_{DD}, I_{RD}$	$T_{vj} = 125$ °C; $V_{DD} = V_{DRM}; V_{RD} = V_{RRM}$	max. 20	mA
$t_{gd}$	$T_{vj} = 25$ °C; $I_G = 1$ A; $di_G/dt = 1$ A/μs		μs
$t_{gr}$	$V_D = - V_{DRM}$		μs
$(dv/dt)_{cr}$	$T_{vj} = 125$ °C	max. 500	V/μs
$(di/dt)_{cr}$	$T_{vj} = 125$ °C; $f = 50...60$ Hz	max. 50	A/μs
$t_q$	$T_{vj} = 125$ °C; typ.	150	μs
$I_H$	$T_{vj} = 25$ °C; typ. / max.	- / 250	mA
$I_L$	$T_{vj} = 25$ °C; $R_G = 33$ Ω	- / 600	mA
$V_{GT}$	$T_{vj} = 25$ °C; d.c.	min. 3	V
$I_{GT}$	$T_{vj} = 25$ °C; d.c.	min. 150	mA
$V_{GD}$	$T_{vj} = 125$ °C; d.c.	max. 0,25	V
$I_{GD}$	$T_{vj} = 125$ °C; d.c.	max. 6	mA
$R_{th(j-s)}$	per thyristor / diode	0,63	K/W K/W K/W
$T_{vj}$		- 40 ... + 125	°C
$T_{stg}$		- 40 ... + 125	°C
$T_{solder}$	terminals	260	°C
$V_{isol}$	a. c. 50 Hz; r.m.s.; 1 s / 1 min. to heatsink	3600 ( 3000 )	V
$M_s$		2,5	Nm
$M_t$			Nm
m	approx.	75	g
Case	SEMIPONT 5	G 61	

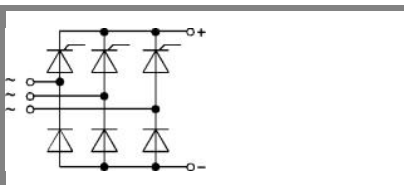

**SKDH**

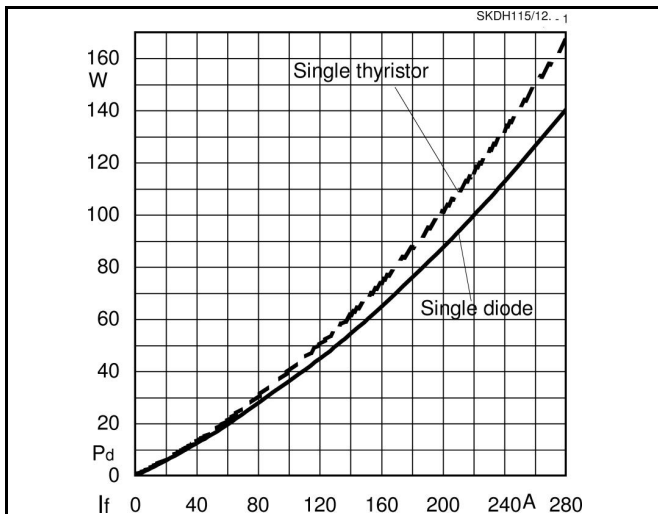

Fig. 1 Power dissipation vs. output current

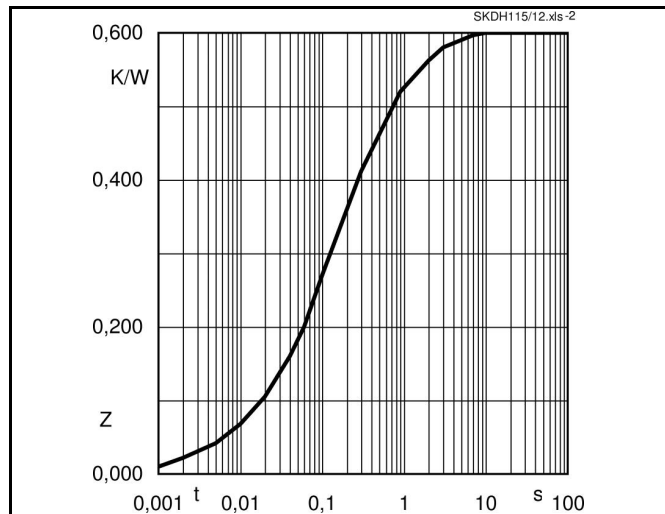

Fig. 2 Transient thermal impedance vs. time

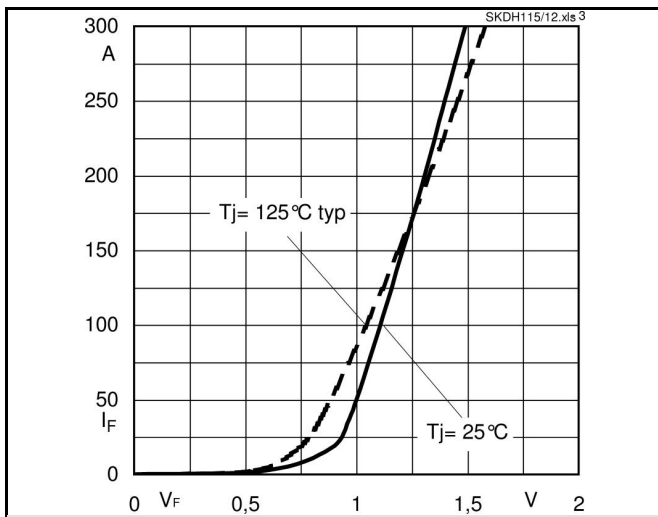

Fig. 3 Single diode on-state characteristic

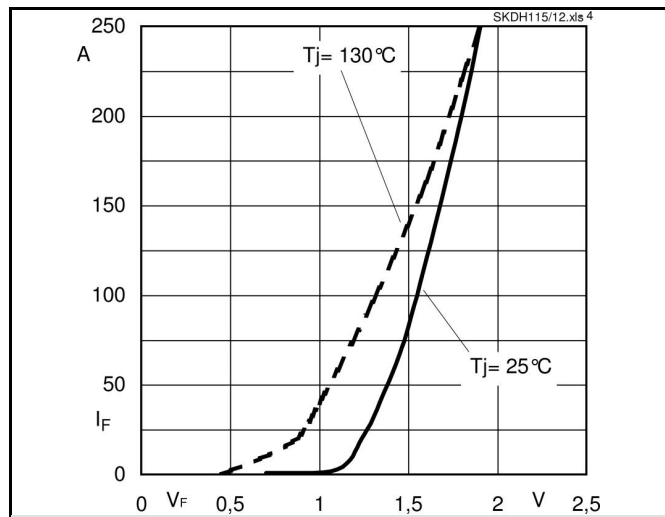

Fig. 4 Single thyristor on-state characteristic

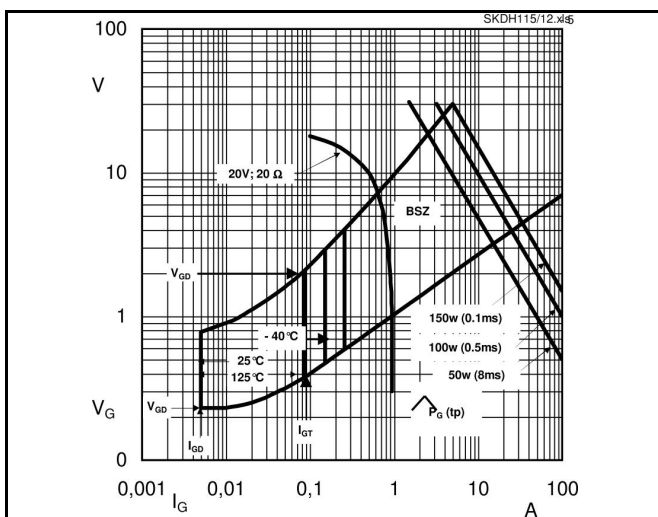
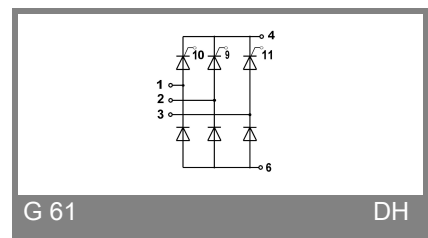
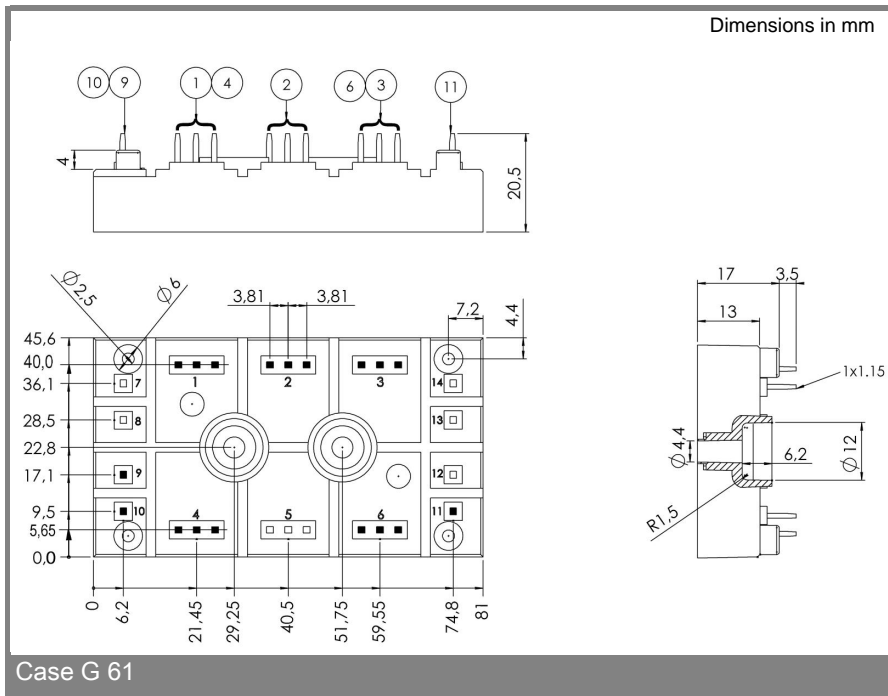

Fig. 5 Gate trigger characteristic

# SKDH 145



\* The specifications of our components may not be considered as an assurance of component characteristics. Components have to be tested for the respective application. Adjustments may be necessary. The use of SEMIKRON products in life support appliances and systems is subject to prior specification and written approval by SEMIKRON. We therefore strongly recommend prior consultation of our personal.