

SKKD 81



SEMIPACK® 1

Rectifier Diode Modules

SKKD 81

Features

- Heat transfer through aluminium oxide ceramic isolated metal baseplate
- Hard soldered joints for high reliability
- UL recognized, file no. E 63 532

Typical Applications*

- Non-controllable rectifiers for AC/AC converters
- Line rectifiers for transistorized AC motor controllers
- Field supply for DC motor

V_{RSM} V	V_{RRM} V	$I_{FRMS} = 140$ A (maximum value for continuous operation) $I_{FAV} = 80$ A (sin. 180; $T_c = 87$ °C)		
500	400	SKKD 81/04		
700	600	SKKD 81/06		
900	800	SKKD 81/08		
1300	1200	SKKD 81/12		
1500	1400	SKKD 81/14		
1700	1600	SKKD 81/16		
1900	1800	SKKD 81/18		

Symbol	Conditions	Values	Units
I_{FAV}	sin. 180; $T_c = 85$ (100) °C	82 (57)	A
I_D	P3/120; $T_a = 45$ °C; B2 / B6	63 / 70	A
	P3/180F; $T_a = 35$ °C; B2 / B6	135 / 175	A
I_{FSM}	$T_{vj} = 25$ °C; 10 ms	2000	A
	$T_{vj} = 125$ °C; 10 ms	1750	A
i^2t	$T_{vj} = 25$ °C; 8,3 ... 10 ms	20000	A ² s
	$T_{vj} = 125$ °C; 8,3 ... 10 ms	15000	A ² s
V_F	$T_{vj} = 25$ °C; $I_F = 300$ A	max. 1,55	V
$V_{(TO)}$	$T_{vj} = 125$ °C	max. 0,85	V
r_T	$T_{vj} = 125$ °C	max. 1,8	mΩ
I_{RD}	$T_{vj} = 125$ °C; $V_{RD} = V_{RRM}$	max. 4,5	mA
$R_{th(j-c)}$	per diode / per module	0,4 / 0,2	K/W
$R_{th(c-s)}$	per diode / per module	0,2 / 0,1	K/W
T_{vj}		- 40 ... + 125	°C
T_{stg}		- 40 ... + 125	°C
V_{isol}	a. c. 50 Hz; r.m.s.; 1 s / 1 min.	3600 / 3000	V~
M_s	to heatsink	5 ± 15 %	Nm
M_t	to terminals	3 ± 15 %	Nm
a		5 * 9,81	m/s ²
m	approx.	95	g
Case	SKKD	A 10	



SKKD

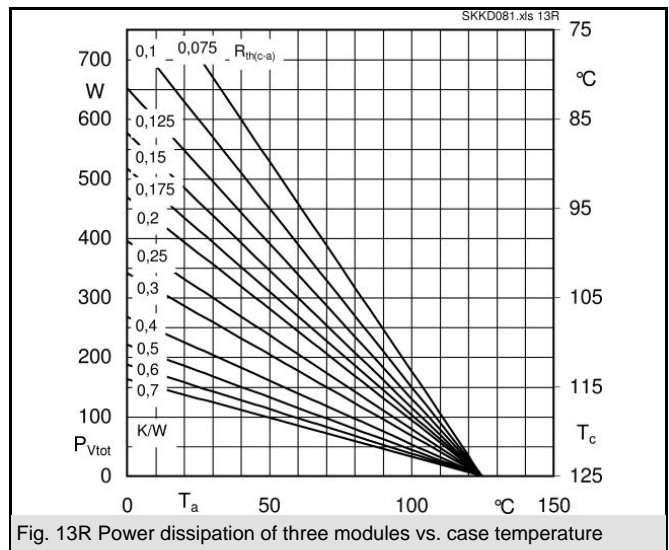
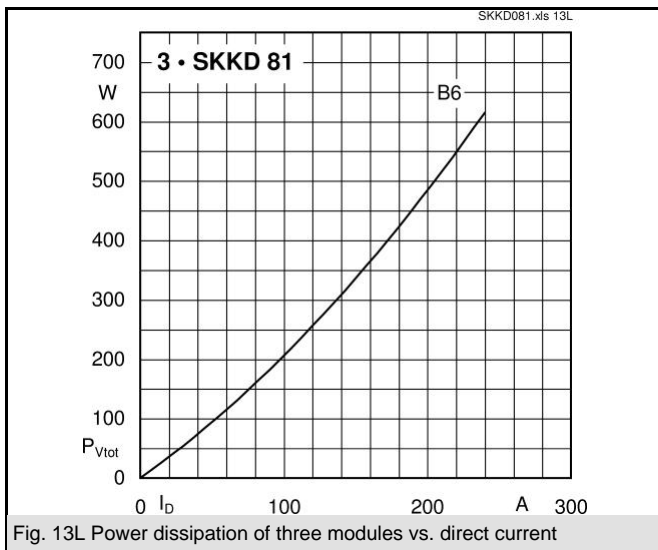
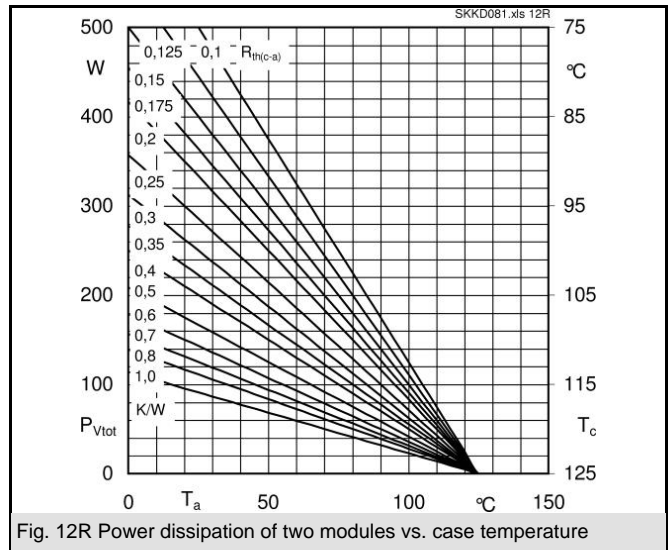
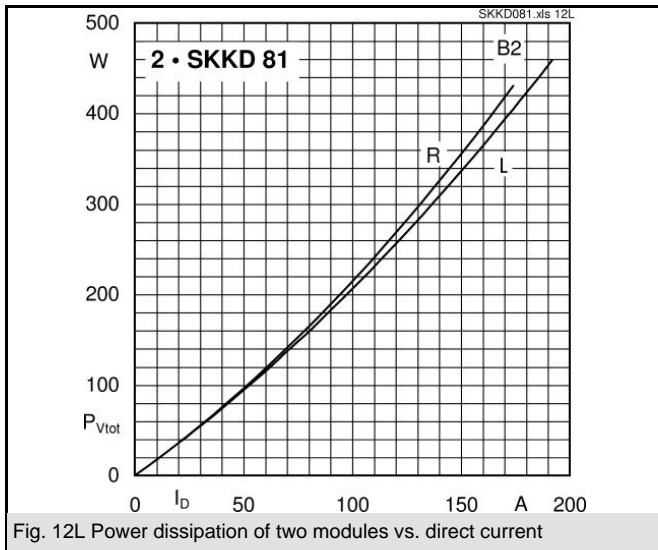
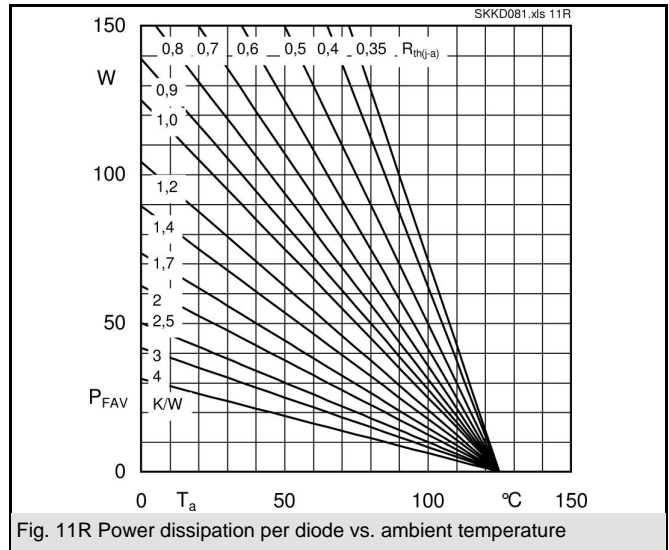
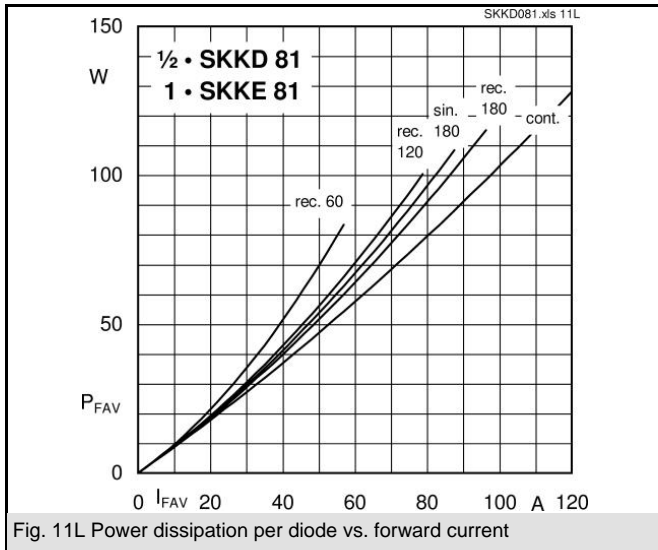

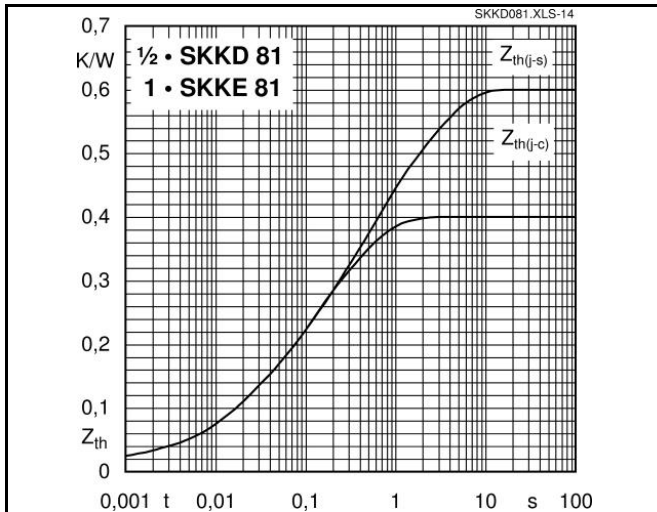

Fig. 14 Transient thermal impedance vs. time

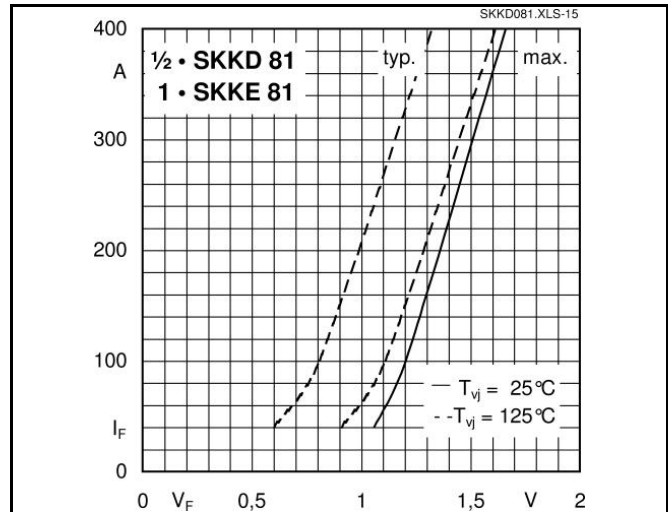

Fig. 15 Forward characteristics

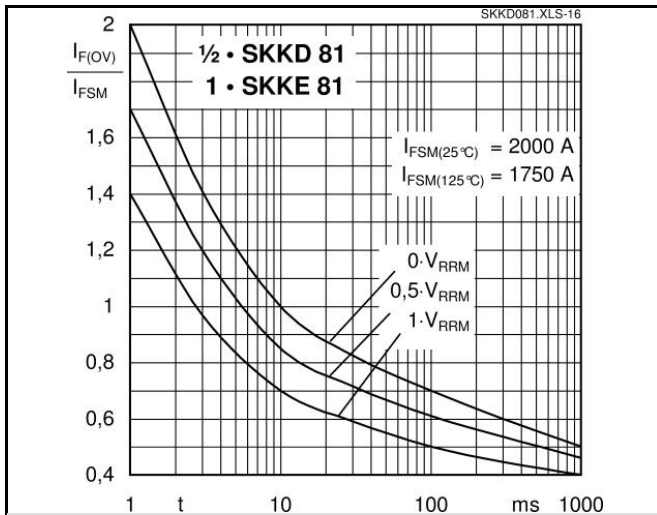
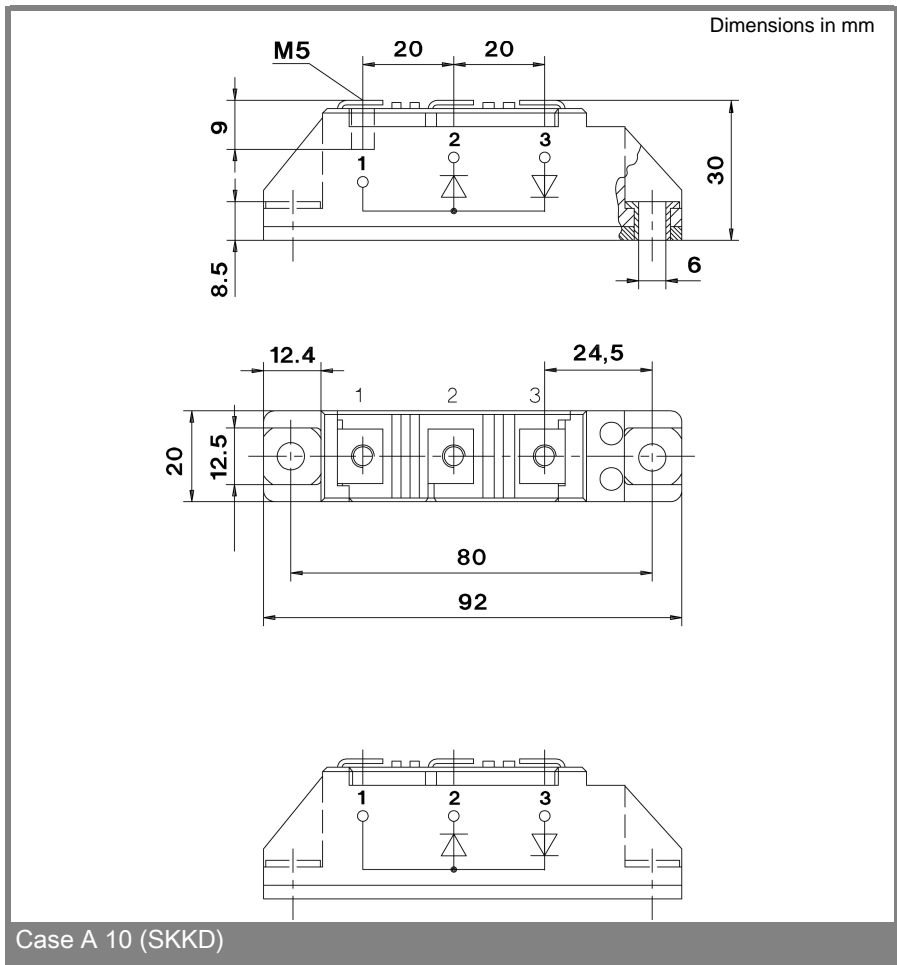

Fig. 16 Surge overload current vs. time



* The specifications of our components may not be considered as an assurance of component characteristics. Components have to be tested for the respective application. Adjustments may be necessary. The use of SEMIKRON products in life support appliances and systems is subject to prior specification and written approval by SEMIKRON. We therefore strongly recommend prior consultation of our personal.