

# SKKT 460, SKKH 460



SEMIPACK® 5

## Thyristor / Diode Modules

SKKT 460

SKKH 460

### Features

- Heat transfer through aluminium nitride ceramic insulated metal baseplate
- Precious metal pressure contacts for high reliability
- UL recognized, file no. E63532

### Typical Applications\*

- AC motor softstarters
- Input converters for AC inverter drives
- DC motor control (e.g. for machine tools)
- Temperature control (e.g. for ovens, chemical processes)
- Professionals light dimming (studios, theaters)

1) see assembly instructions

$V_{RSM}$ V	$V_{RRM}, V_{DRM}$ V	$I_{TRMS} = 800$ A (maximum value for continuous operation) $I_{TAV} = 460$ A (sin. 180; $T_c = 85$ °C)	
1700	1600	SKKT 460/16E	SKKH 460/16E
2100	2000	SKKT 460/20E H4	SKKH 460/20E H4
2300	2200	SKKT 460/22E H4	SKKH 460/22E H4

Symbol	Conditions	Values	Units
$I_{TAV}$	sin. 180; $T_c = 85$ (100) °C;	460 (335)	A
$I_{TSM}$	$T_{vj} = 25$ °C; 10 ms $T_{vj} = 130$ °C; 10 ms	18000 15500	A
$i^2t$	$T_{vj} = 25$ °C; 8,3 .. 10 ms $T_{vj} = 130$ °C; 8,3 ... 10 ms	1620000 1200000	A <sup>2</sup> s
$V_T$	$T_{vj} = 25$ °C; $I_T = 1400$ A	max. 1,6	V
$V_{T(TO)}$	$T_{vj} = 130$ °C	max. 0,88	V
$r_T$	$T_{vj} = 130$ °C	max. 0,45	mΩ
$I_{DD}, I_{RD}$	$T_{vj} = 130$ °C; $V_{RD} = V_{RRM}; V_{DD} = V_{DRM}$	max. 240	mA
$t_{gd}$	$T_{vj} = 25$ °C; $I_G = 1$ A; $di_G/dt = 1$ A/μs	1	μs
$t_{gr}$	$V_D = 0,67 * V_{DRM}$	2	μs
$(di/dt)_{cr}$	$T_{vj} = 130$ °C	max. 250	A/μs
$(dv/dt)_{cr}$	$T_{vj} = 130$ °C	max. 1000	V/μs
$t_q$	$T_{vj} = 130$ °C	100 .. 200	μs
$I_H$	$T_{vj} = 25$ °C; typ. / max.	150 / 500	mA
$I_L$	$T_{vj} = 25$ °C; $R_G = 33$ Ω; typ. / max.	300 / 2000	mA
$V_{GT}$	$T_{vj} = 25$ °C; d.c.	min. 3	V
$I_{GT}$	$T_{vj} = 25$ °C; d.c.	min. 200	mA
$V_{GD}$	$T_{vj} = 130$ °C; d.c.	max. 0,25	V
$I_{GD}$	$T_{vj} = 130$ °C; d.c.	max. 10	mA
$R_{th(j-c)}$	cont.; per thyristor / per module	0,072 / 0,035	K/W
$R_{th(j-c)}$	sin. 180°; per thyristor / per module	0,074 / 0,037	K/W
$R_{th(j-c)}$	rec. 120°; per thyristor / per module	0,078 / 0,039	K/W
$R_{th(c-s)}$	per thyristor / per module	0,02 / 0,01	K/W
$T_{vj}$		- 40 ... + 130	°C
$T_{stg}$		- 40 ... + 125	°C
$V_{isol}$	a.c. 50 Hz; r.m.s.; 1 s / 1 min.	3600 / 3000	V~
$V_{isol}$	a.c. 50 Hz; r.m.s.; 1 s / 1 min. for SKK...H4	4800 / 4000	V~
$M_s$	to heatsink	5 ± 15% <sup>1)</sup>	Nm
$M_t$	to terminals	12 ± 15%	Nm
$a$		5 * 9,81	m/s <sup>2</sup>
$m$	approx.	1400	g
Case	SKKT	A 60b	
	SKKH	A 66b	

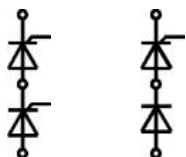

SKKT

SKKH

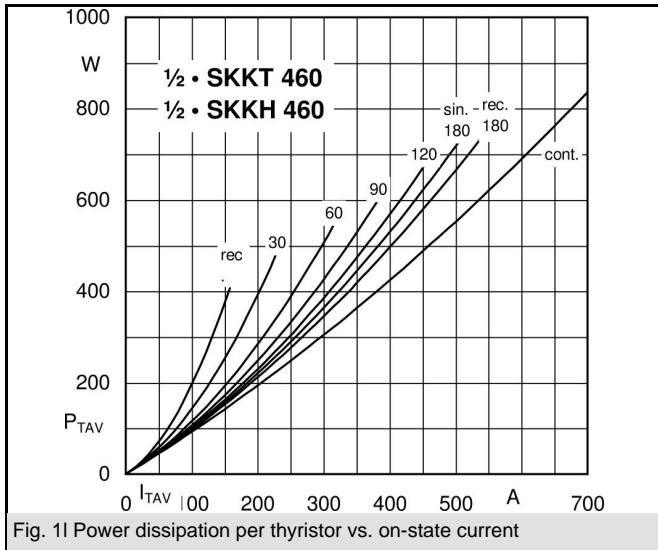

Fig. 1l Power dissipation per thyristor vs. on-state current

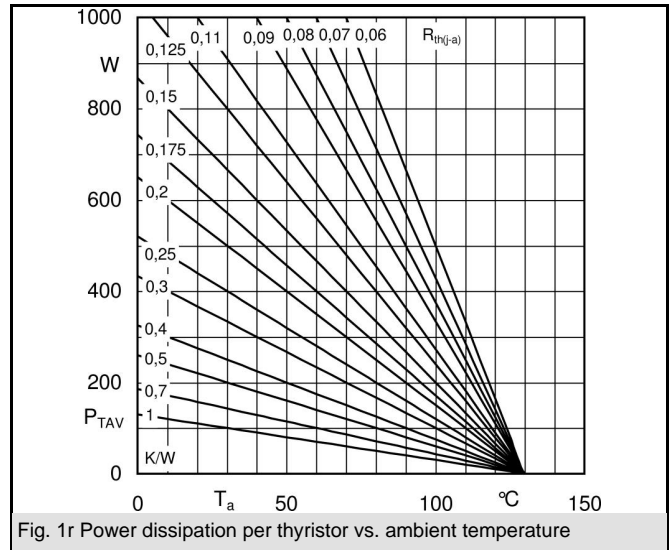

Fig. 1r Power dissipation per thyristor vs. ambient temperature

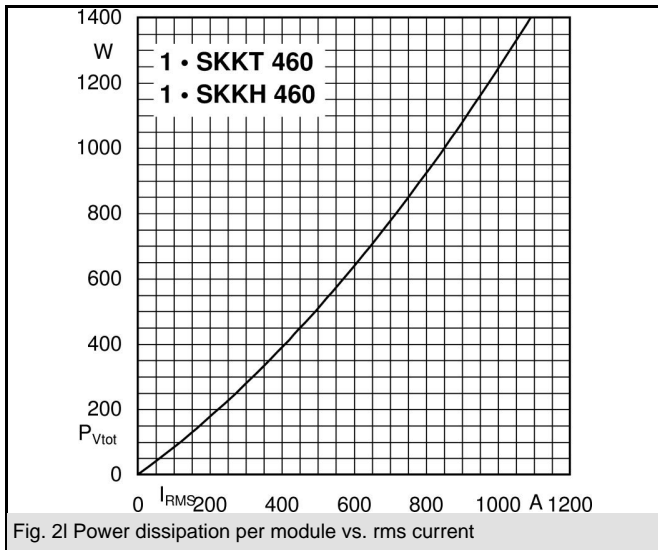

Fig. 2l Power dissipation per module vs. rms current

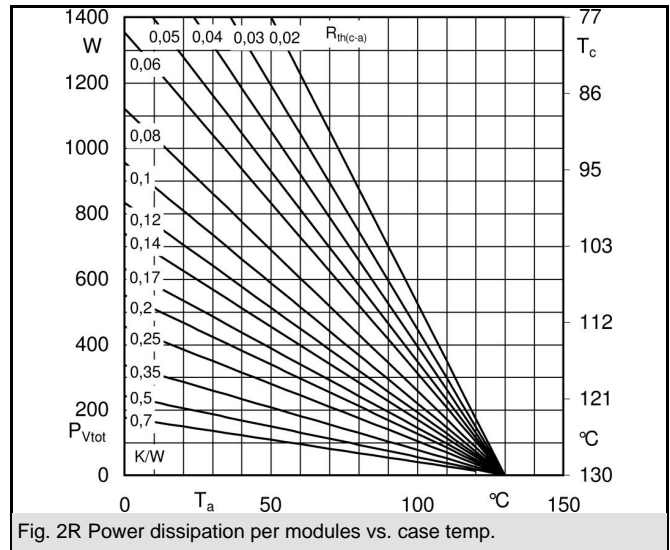

Fig. 2R Power dissipation per modules vs. case temp.

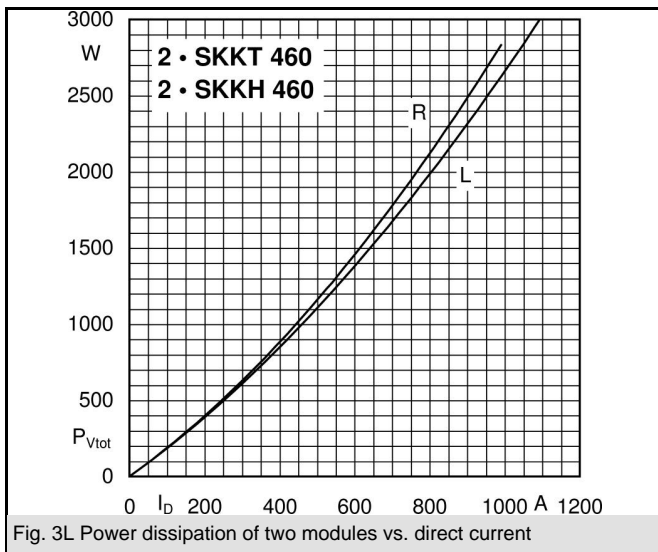

Fig. 3L Power dissipation of two modules vs. direct current

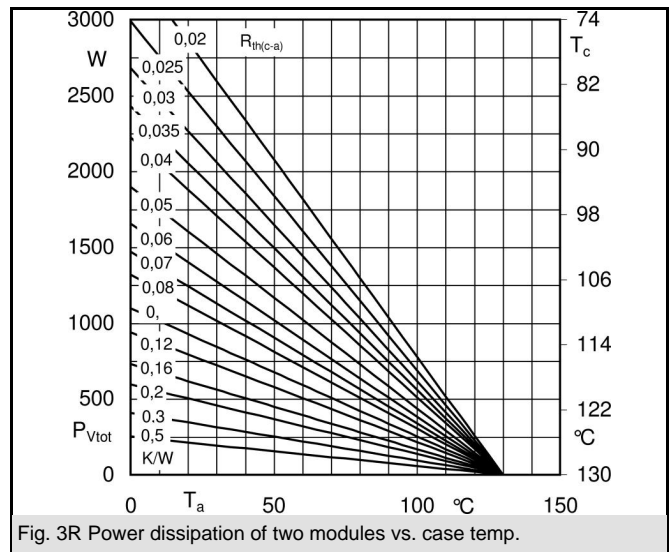
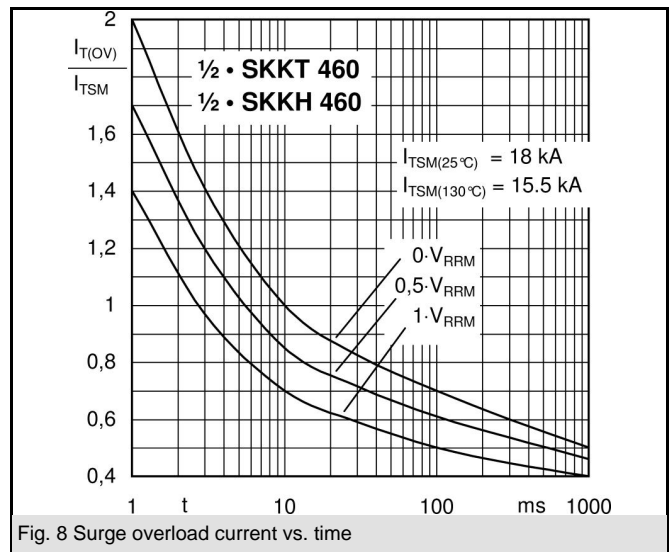
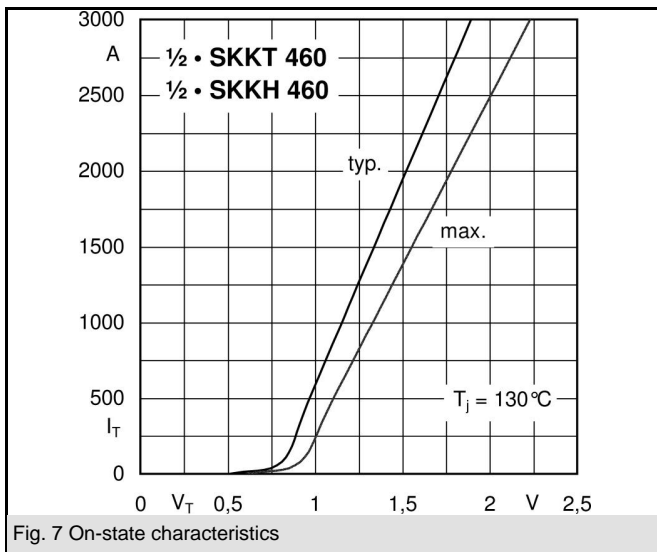
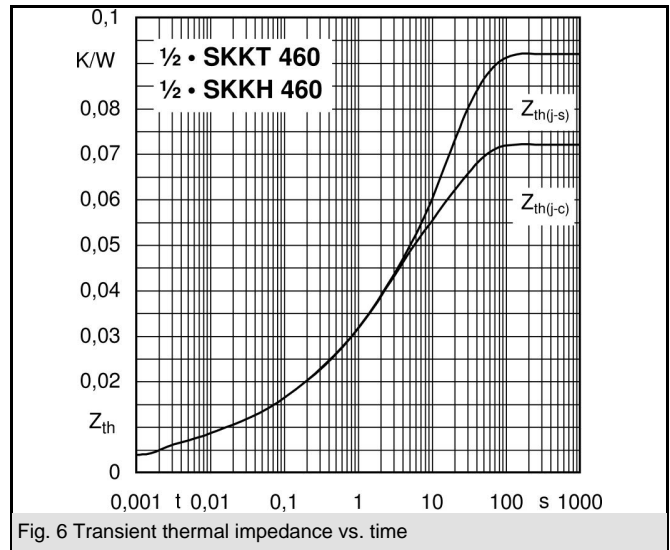
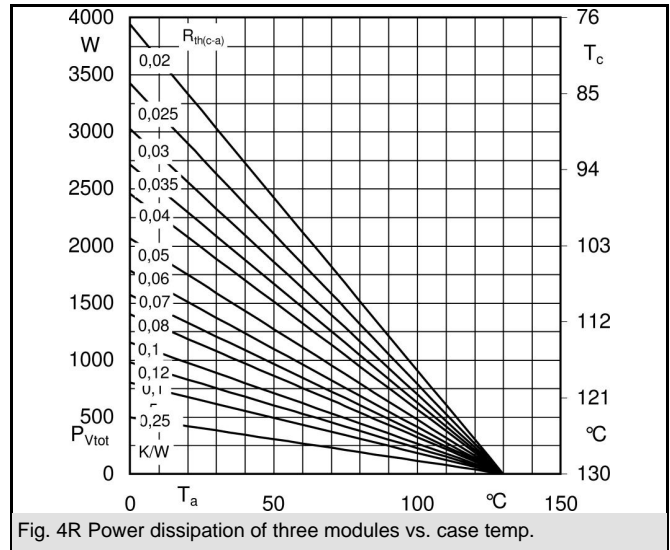
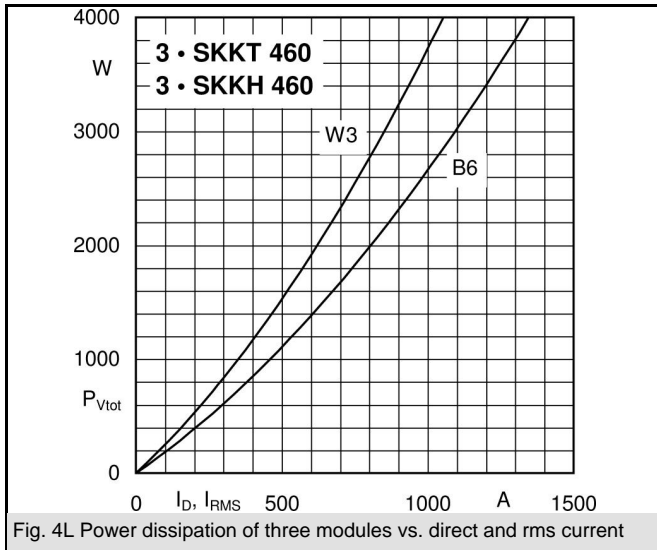
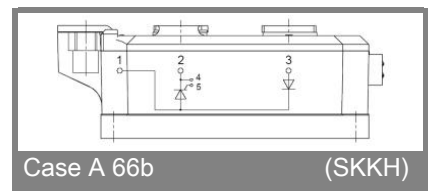
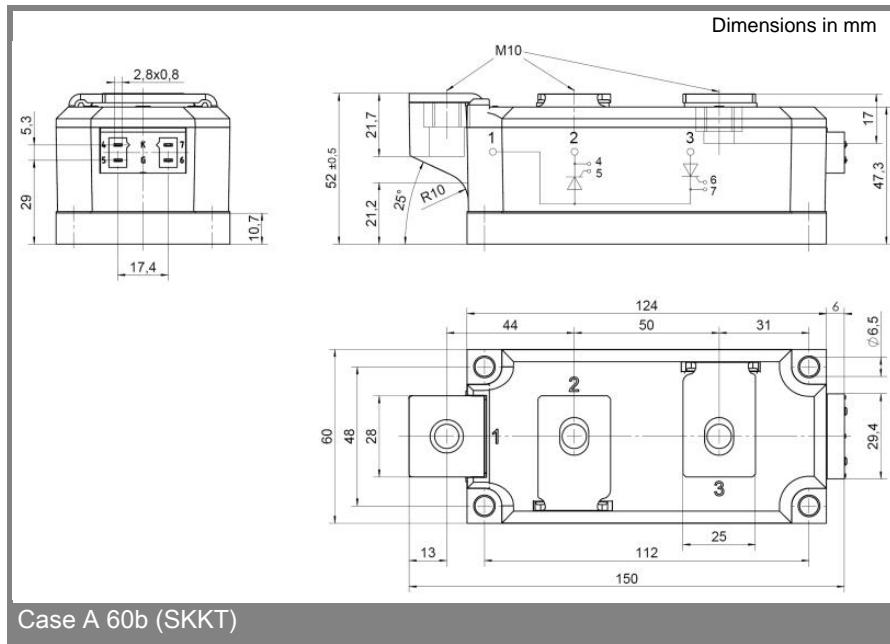
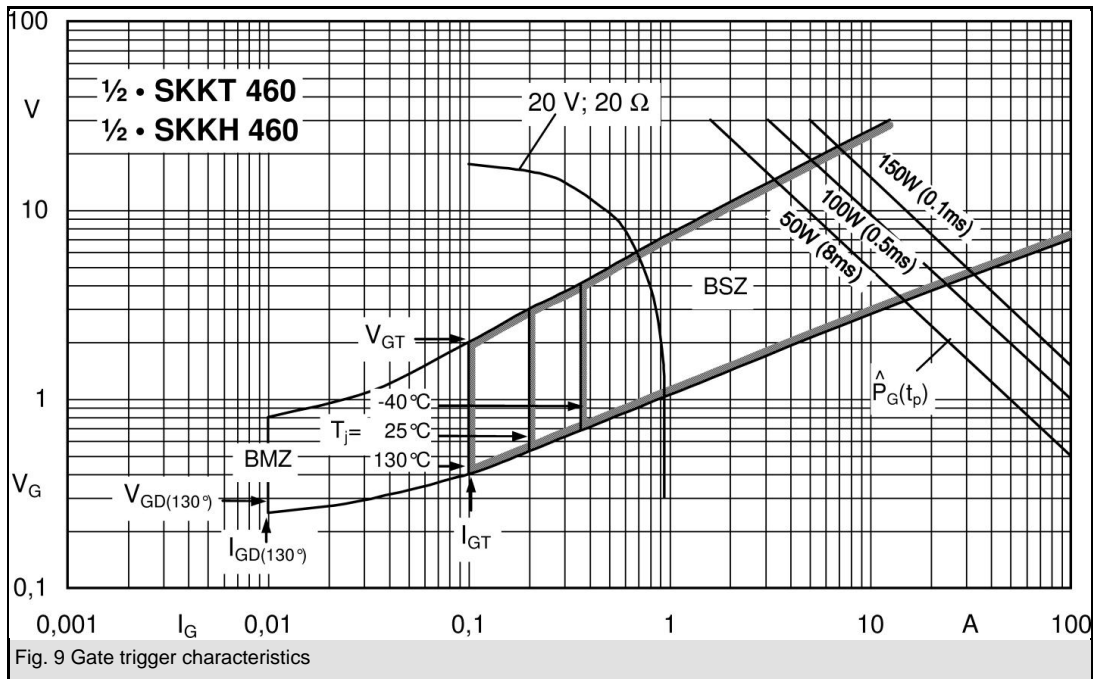

Fig. 3R Power dissipation of two modules vs. case temp.

# SKKT 460, SKKH 460





\* The specifications of our components may not be considered as an assurance of component characteristics. Components have to be tested for the respective application. Adjustments may be necessary. The use of SEMIKRON products in life support appliances and systems is subject to prior specification and written approval by SEMIKRON. We therefore strongly recommend prior consultation of our staff.