

SKKD 701



SEMIPACK®5

Rectifier Diode Modules

SKKD 701

Features

- Heat transfer through aluminium nitride ceramic insulated metal baseplate
- Precise metal pressure contacts for high reliability
- UL recognized, file no. E63532

Typical Applications*

- Uncontrolled rectifiers for AC/AC converters
- Line rectifiers for transistorized AC motor controller
- Field supply for DC motors

1) see assembly instructions

V_{RSM} V	V_{RRM} V	$I_{FRMS} = 1100$ A (maximum value for continuous operation) $I_{FAV} = 701$ A (sin. 180; $T_C = 100$ °C)		
1300	1200	SKKD 701/12		
1700	1600	SKKD 701/16		
1900	1800	SKKD 701/18		
2300	2200	SKKD 701/22 H4		

Symbol	Conditions	Values	Units
I_{FAV}	sin. 180; $T_C = 100$ (85) °C	701 (820)	A
I_{FSM}	$T_{vj} = 25$ °C; 10 ms	25000	A
	$T_{vj} = 160$ °C; 10 ms	22500	A
i^2t	$T_{vj} = 25$ °C; 8,3 ... 10 ms	3125000	A ² s
	$T_{vj} = 160$ °C; 8,3 ... 10 ms	2531250	A ² s
V_F	$T_{vj} = 25$ °C; $I_F = 2000$ A	max. 1,25	V
$V_{(TO)}$	$T_{vj} = 160$ °C	max. 0,7	V
r_T	$T_{vj} = 160$ °C	max. 0,28	mΩ
I_{RD}	$T_{vj} = 160$ °C; $V_{RD} = V_{RRM}$	max. 30	mA
$R_{th(j-c)}$	cont.; per diode / per module	0,069 / 0,034	K/W
	sin. 180; per diode / per module	0,072 / 0,036	K/W
	rec. 120; per diode / per module	0,077 / 0,038	K/W
$R_{th(c-s)}$	per diode / per module	0,02 / 0,01	K/W
T_{vj}		- 40 ... + 160	°C
T_{stg}		- 40 ... + 125	°C
V_{isol}	a.c. 50 Hz, r.m.s.; 1 s / 1 min.	3600 / 3000	V~
V_{isol}	a.c. 50 Hz, r.m.s.; 1 s / 1 min. for SKK... H4	4800 / 4000	V~
M_s	to heatsink	5 ± 15 % ¹⁾	Nm
M_t	to terminals	12 ± 15 %	Nm
a		$5 * 9,81$	m/s ²
m	approx.	1400	g
Case		A 75b	

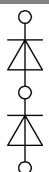

SKKD

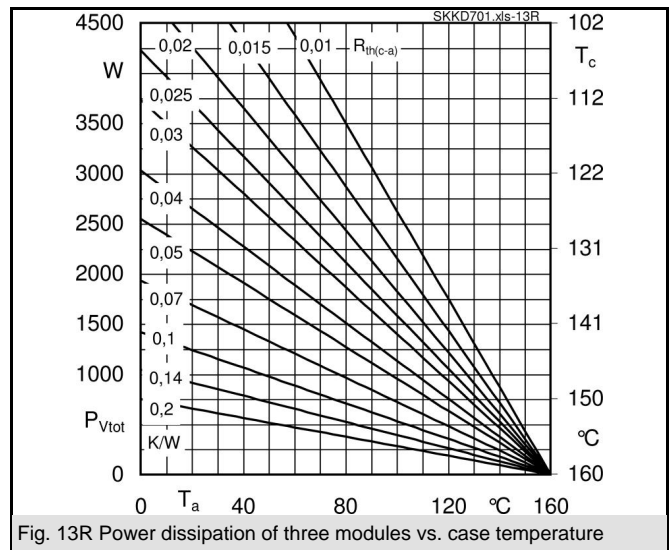
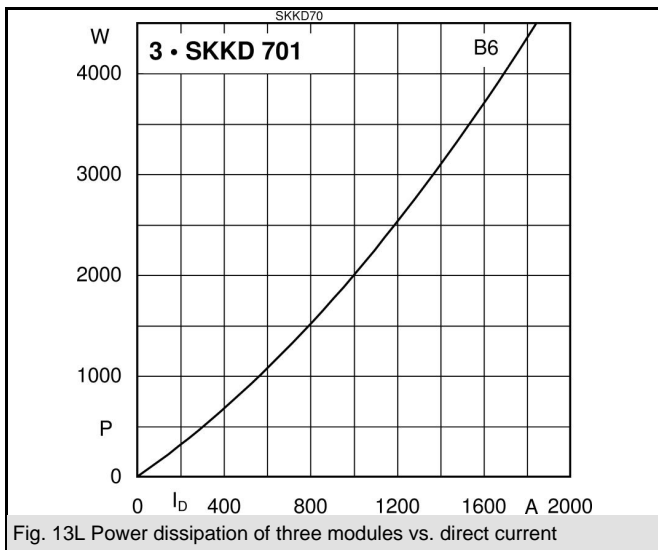
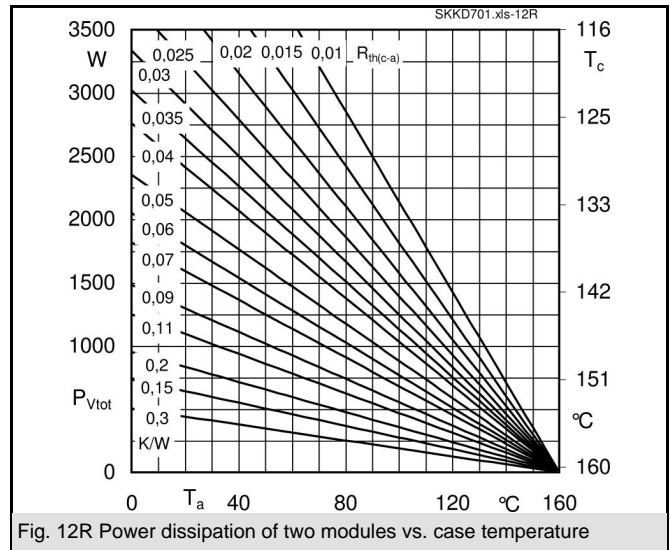
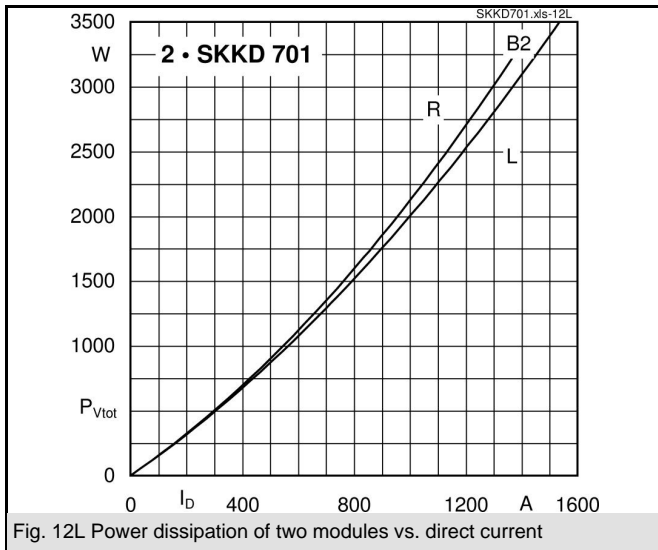
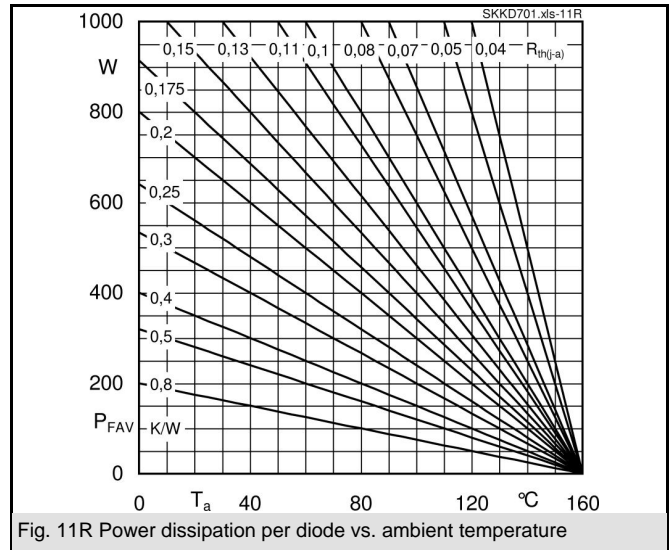
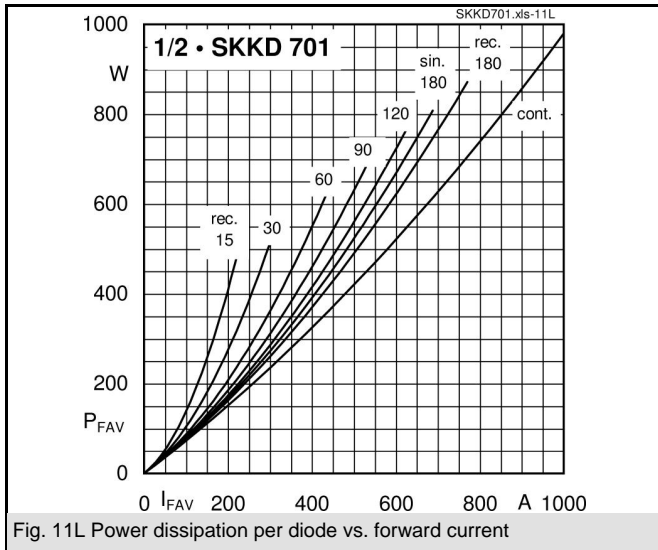

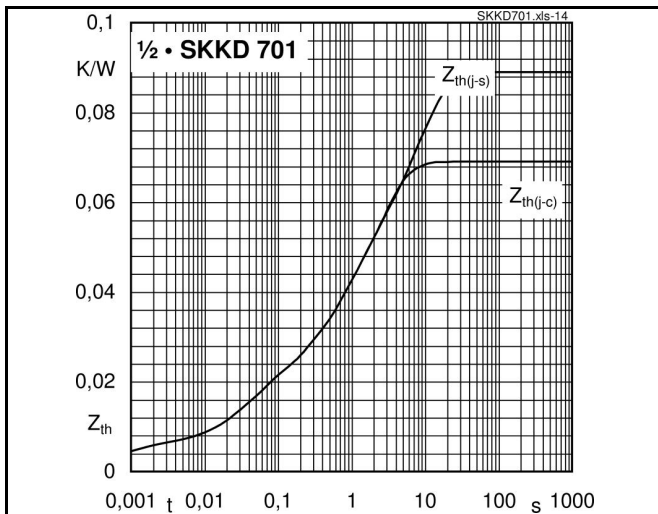

Fig. 14 Transient thermal impedance vs. time

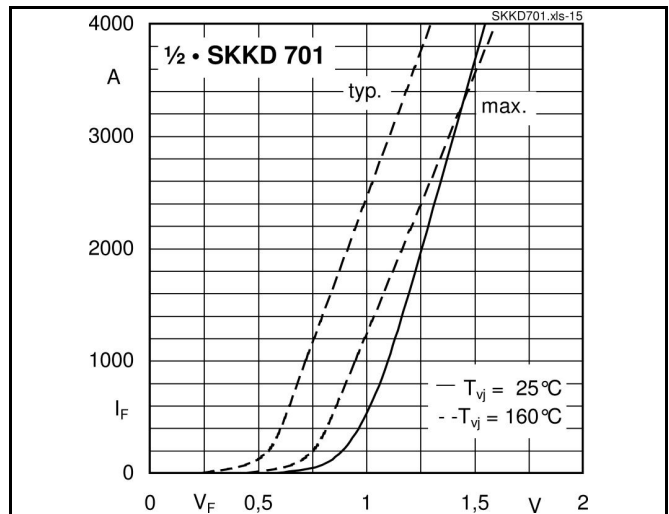

Fig. 15 Forward characteristics

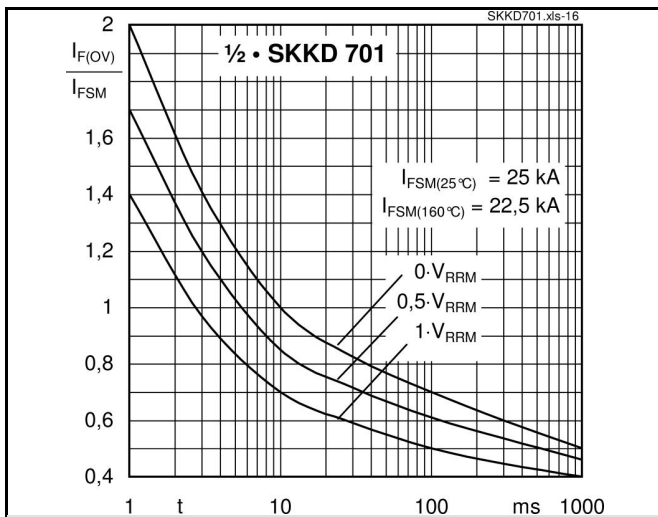
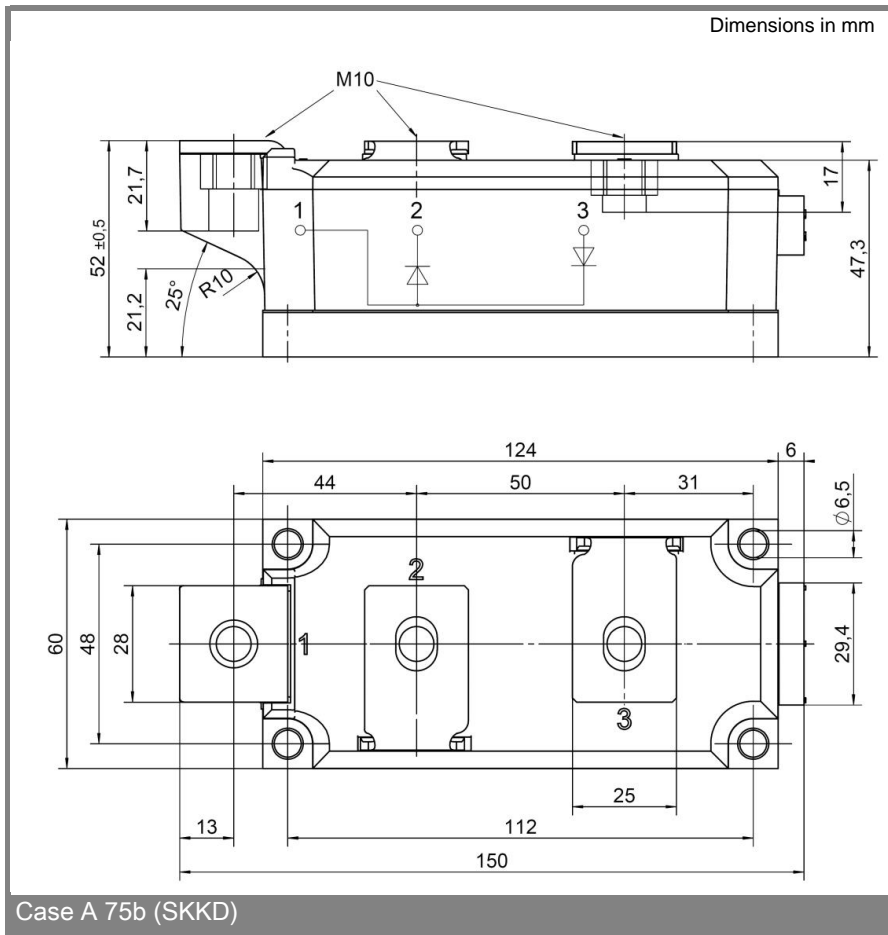

Fig. 16 Surge overload current vs. time



* The specifications of our components may not be considered as an assurance of component characteristics. Components have to be tested for the respective application. Adjustments may be necessary. The use of SEMIKRON products in life support appliances and systems is subject to prior specification and written approval by SEMIKRON. We therefore strongly recommend prior consultation of our staff.