

SKM400GAL12E4



SEMITRANS®3

IGBT4 Modules

SKM400GAL12E4

Features

- IGBT4 = 4. Generation (Trench)IGBT
- VCEsat with positive temperature coefficient
- High short circuit capability, self limiting to 6 x I_{CNOM}
- Soft switching 4. Generation CAL diode (CAL4)

Typical Applications

- DC/DC – converter
- Brake chopper
- Switched reluctance motor
- DC – motor

Remarks

- Case temperature limited to T_c = 125°C max, recomb. T_{op} = -40 ... +150°C, product rel. results valid for T_j = 150°

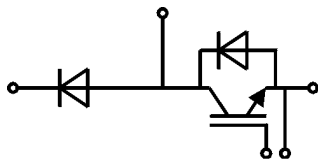

GAL

Absolute Maximum Ratings

Symbol	Conditions	Values	Unit	
IGBT				
V _{CES}		1200	V	
I _C	T _j = 175 °C	T _c = 25 °C	618	A
		T _c = 80 °C	475	A
I _{Cnom}		400	A	
I _{CRM}	I _{CRM} = 3xI _{Cnom}	1200	A	
V _{GES}		-20 ... 20	V	
t _{psc}	V _{CC} = 800 V V _{GE} ≤ 15 V V _{CES} ≤ 1200 V	T _j = 150 °C	10	µs
T _j		-40 ... 175	°C	
Inverse diode				
I _F	T _j = 175 °C	T _c = 25 °C	440	A
		T _c = 80 °C	329	A
I _{Fnom}		400	A	
I _{FRM}	I _{FRM} = 3xI _{Fnom}	1200	A	
I _{FSM}	t _p = 10 ms, sin 180°, T _j = 25 °C	1980	A	
T _j		-40 ... 175	°C	
Freewheeling diode				
I _F	T _j = 175 °C	T _c = 25 °C	440	A
		T _c = 80 °C	329	A
I _{Fnom}		400	A	
I _{FRM}	I _{FRM} = 3xI _{Fnom}	1200	A	
I _{FSM}	t _p = 10 ms, sin 180°, T _j = 25 °C	1980	A	
T _j		-40 ... 175	°C	
Module				
I _{t(RMS)}		500	A	
T _{stg}		-40 ... 125	°C	
V _{isol}	AC sinus 50Hz, t = 1 min	4000	V	

Characteristics

Symbol	Conditions	min.	typ.	max.	Unit
IGBT					
V _{CE(sat)}	I _C = 400 A V _{GE} = 15 V chiplevel	T _j = 25 °C	1.8	2.05	V
		T _j = 150 °C	2.2	2.4	V
V _{CE0}		T _j = 25 °C	0.8	0.9	V
		T _j = 150 °C	0.7	0.8	V
r _{CE}	V _{GE} = 15 V	T _j = 25 °C	2.5	2.9	mΩ
		T _j = 150 °C	3.8	4.0	mΩ
V _{GE(th)}	V _{GE} = V _{CE} , I _C = 15.2 mA	5	5.8	6.5	V
I _{CES}	V _{GE} = 0 V V _{CE} = 1200 V	T _j = 25 °C	0.1	0.3	mA
		T _j = 150 °C			mA
C _{ies}	V _{CE} = 25 V		24.6		nF
C _{oes}	V _{GE} = 0 V		1.62		nF
C _{res}			1.38		nF
Q _G	V _{GE} = - 8 V...+ 15 V		2260		nC
R _{Gint}	T _j = 25 °C		1.9		Ω



SEMITRANS®3

IGBT4 Modules

SKM400GAL12E4

Features

- IGBT4 = 4. Generation (Trench)IGBT
- VCEsat with positive temperature coefficient
- High short circuit capability, self limiting to $6 \times I_{CNOM}$
- Soft switching 4. Generation CAL diode (CAL4)

Typical Applications

- DC/DC – converter
- Brake chopper
- Switched reluctance motor
- DC – motor

Remarks

- Case temperature limited to $T_C = 125^\circ\text{C}$ max, recomm. $T_{op} = -40 \dots +150^\circ\text{C}$, product rel. results valid for $T_j = 150^\circ$

Characteristics						
Symbol	Conditions		min.	typ.	max.	Unit
$t_{d(on)}$	$V_{CC} = 600\text{ V}$	$T_j = 150^\circ\text{C}$		242		ns
t_r	$I_C = 400\text{ A}$	$T_j = 150^\circ\text{C}$		47		ns
E_{on}	$V_{GE} = \pm 15\text{ V}$	$T_j = 150^\circ\text{C}$		33		mJ
$t_{d(off)}$	$R_{G\ on} = 1\ \Omega$	$T_j = 150^\circ\text{C}$		580		ns
t_f	$R_{G\ off} = 1\ \Omega$	$T_j = 150^\circ\text{C}$		101		ns
E_{off}	$di/dt_{on} = 9700\text{ A}/\mu\text{s}$	$T_j = 150^\circ\text{C}$		56		mJ
$R_{th(j-c)}$	per IGBT				0.072	K/W
Inverse diode						
$V_F = V_{EC}$	$I_F = 400\text{ A}$	$T_j = 25^\circ\text{C}$		2.2	2.52	V
	$V_{GE} = 0\text{ V}$	$T_j = 150^\circ\text{C}$		2.15	2.47	V
	chip					
V_{F0}		$T_j = 25^\circ\text{C}$		1.3	1.5	V
		$T_j = 150^\circ\text{C}$		0.9	1.1	V
r_F		$T_j = 25^\circ\text{C}$		2.3	2.5	m Ω
		$T_j = 150^\circ\text{C}$		3.1	3.4	m Ω
I_{RRM}	$I_F = 400\text{ A}$	$T_j = 150^\circ\text{C}$		450		A
Q_{rr}	$di/dt_{off} = 8800\text{ A}/\mu\text{s}$	$T_j = 150^\circ\text{C}$		68		μC
E_{rr}	$V_{GE} = \pm 15\text{ V}$	$T_j = 150^\circ\text{C}$		30.5		mJ
	$V_{CC} = 600\text{ V}$					
$R_{th(j-c)}$	per diode				0.14	K/W
Freewheeling diode						
$V_F = V_{EC}$	$I_F = 400\text{ A}$	$T_j = 25^\circ\text{C}$		2.2	2.52	V
	$V_{GE} = 0\text{ V}$	$T_j = 150^\circ\text{C}$		2.15	2.47	V
	chip					
V_{F0}		$T_j = 25^\circ\text{C}$		1.3	1.5	V
		$T_j = 150^\circ\text{C}$		0.9	1.1	V
r_F		$T_j = 25^\circ\text{C}$		2.3	2.5	m Ω
		$T_j = 150^\circ\text{C}$		3.1	3.4	m Ω
I_{RRM}	$I_F = 400\text{ A}$	$T_j = 150^\circ\text{C}$		450		A
Q_{rr}	$di/dt_{off} = 8800\text{ A}/\mu\text{s}$	$T_j = 150^\circ\text{C}$		68		μC
E_{rr}	$V_{GE} = \pm 15\text{ V}$	$T_j = 150^\circ\text{C}$		30.5		mJ
	$V_{CC} = 600\text{ V}$					
$R_{th(j-c)}$	per Diode				0.14	K/W
Module						
L_{CE}				15	20	nH
$R_{CC+EE'}$	terminal-chip	$T_C = 25^\circ\text{C}$		0.25		m Ω
		$T_C = 125^\circ\text{C}$		0.5		m Ω
$R_{th(c-s)}$	per module			0.02	0.038	K/W
M_s	to heat sink M6			3	5	Nm
M_t		to terminals M6		2.5	5	Nm
						Nm
w					325	g

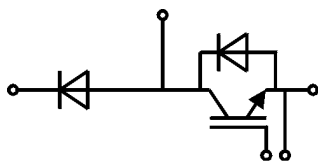

GAL

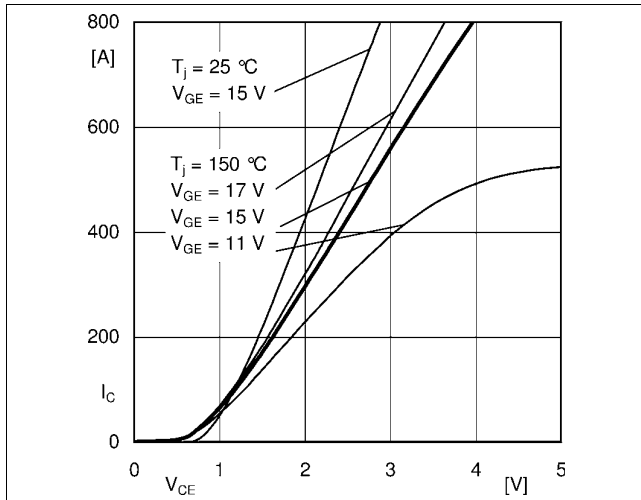

Fig. 1: Typ. output characteristic, inclusive $R_{CC} + E_{E'}$

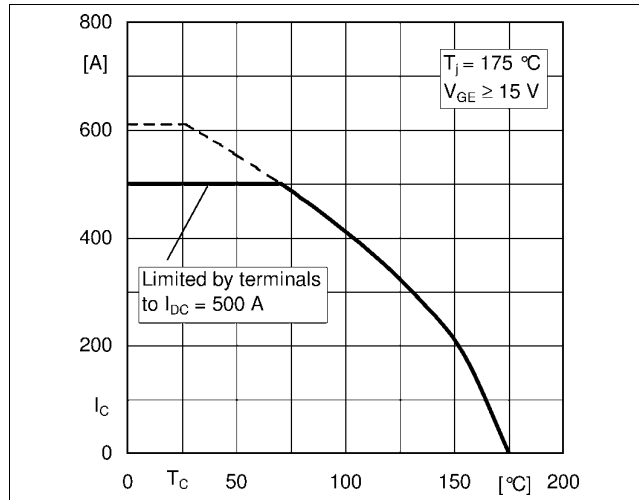

Fig. 2: Rated current vs. temperature $I_c = f(T_C)$

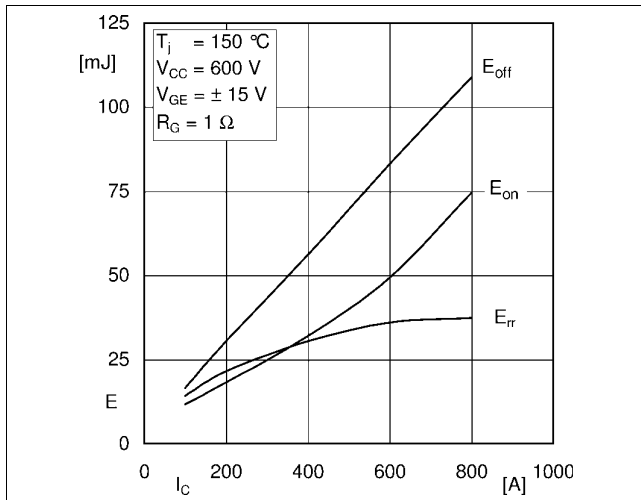

Fig. 3: Typ. turn-on /-off energy = $f(I_c)$

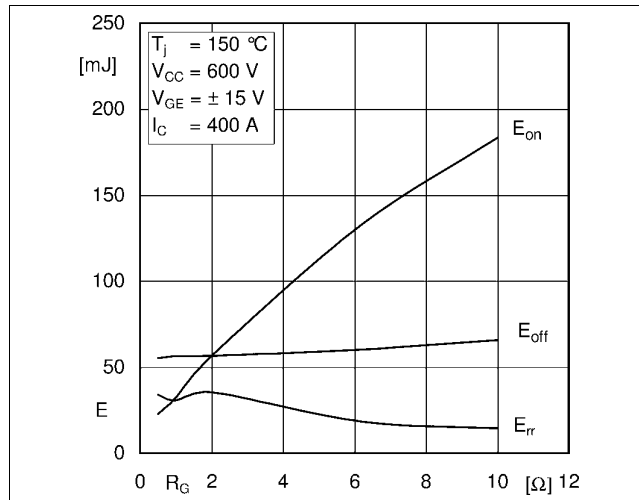

Fig. 4: Typ. turn-on /-off energy = $f(R_G)$

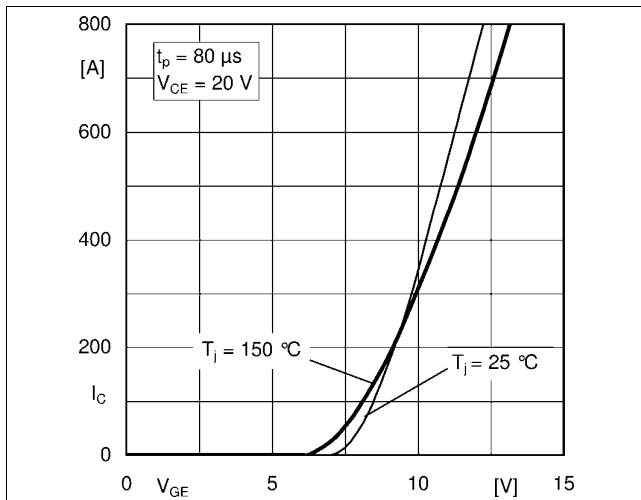

Fig. 5: Typ. transfer characteristic

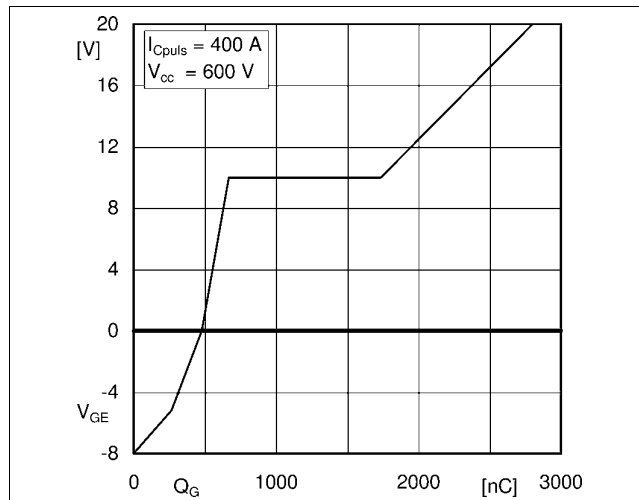

Fig. 6: Typ. gate charge characteristic

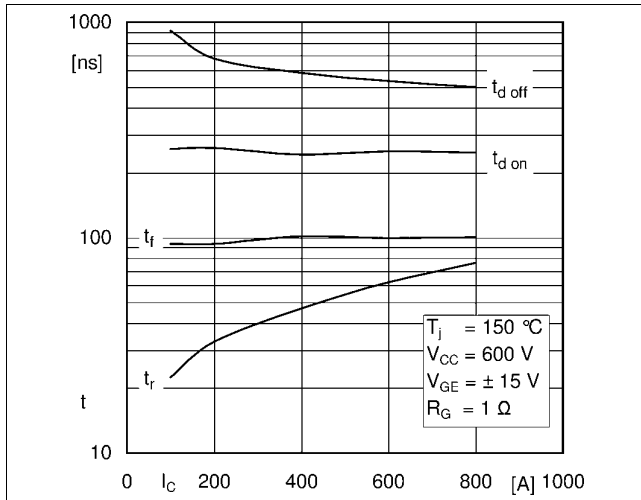

Fig. 7: Typ. switching times vs. I_C

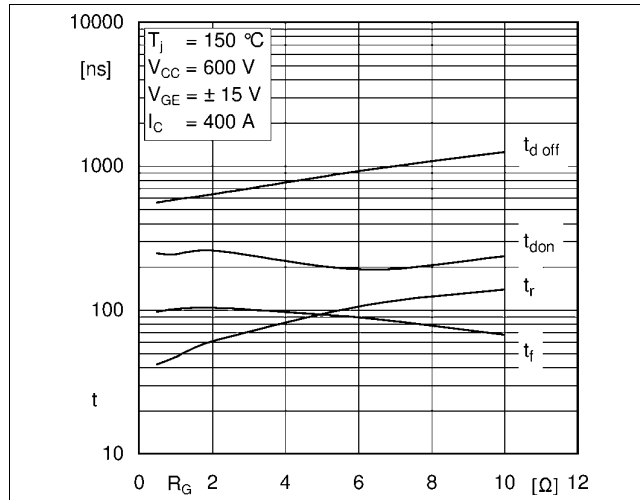

Fig. 8: Typ. switching times vs. gate resistor R_G

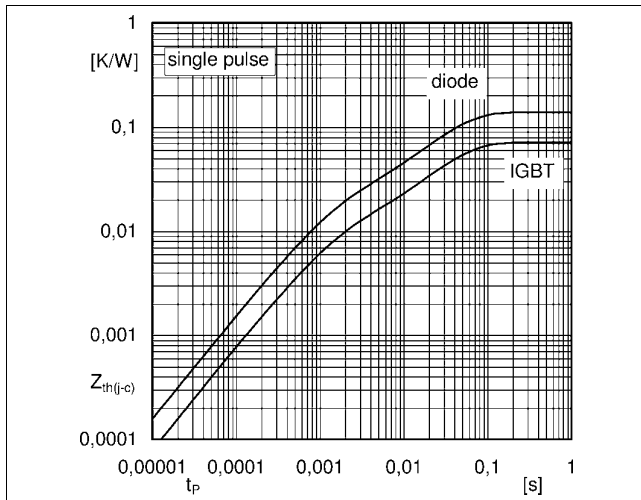

Fig. 9: Transient thermal impedance

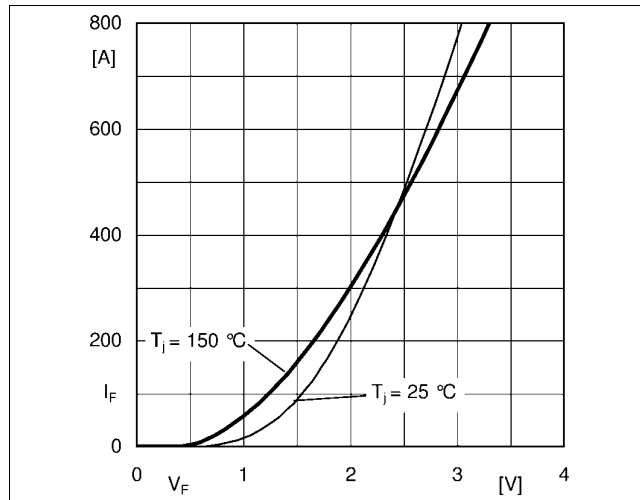

Fig. 10: CAL diode forward characteristic

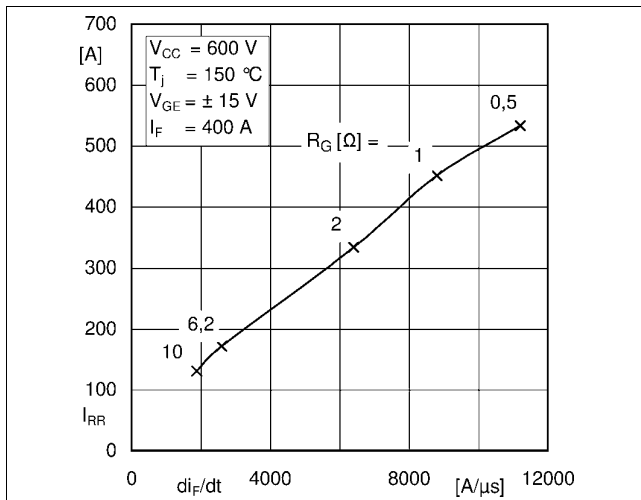

Fig. 11: CAL diode peak reverse recovery current

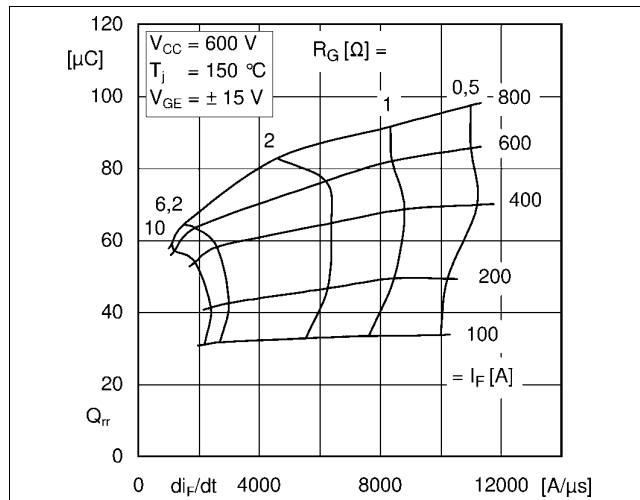
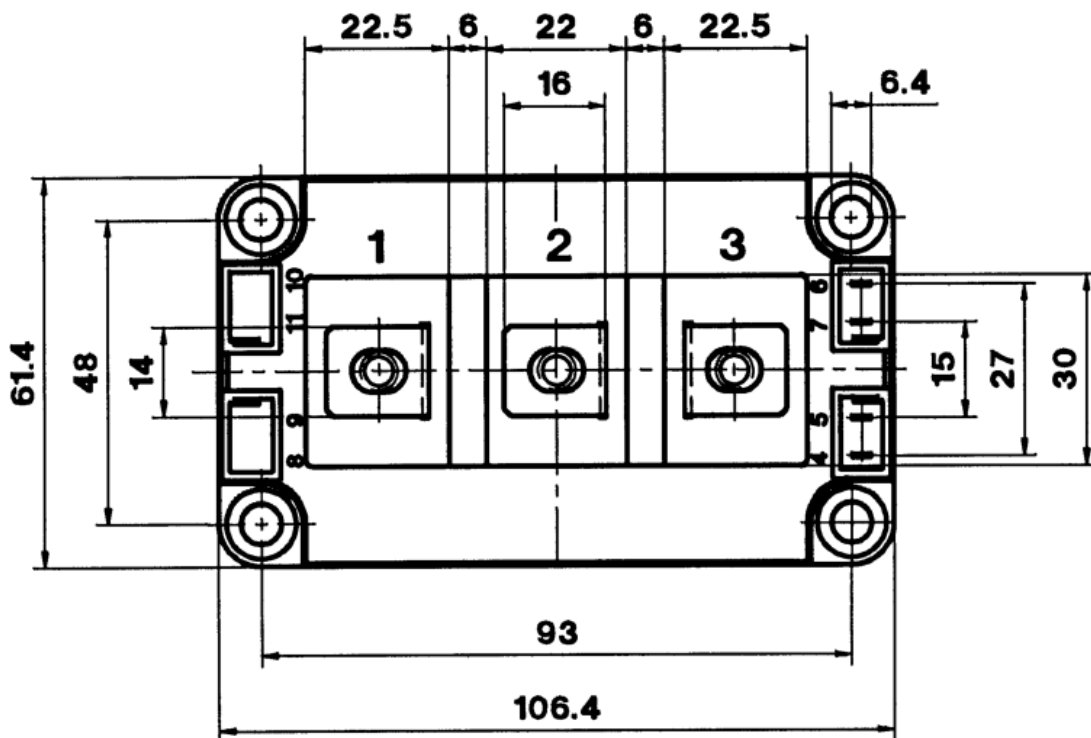
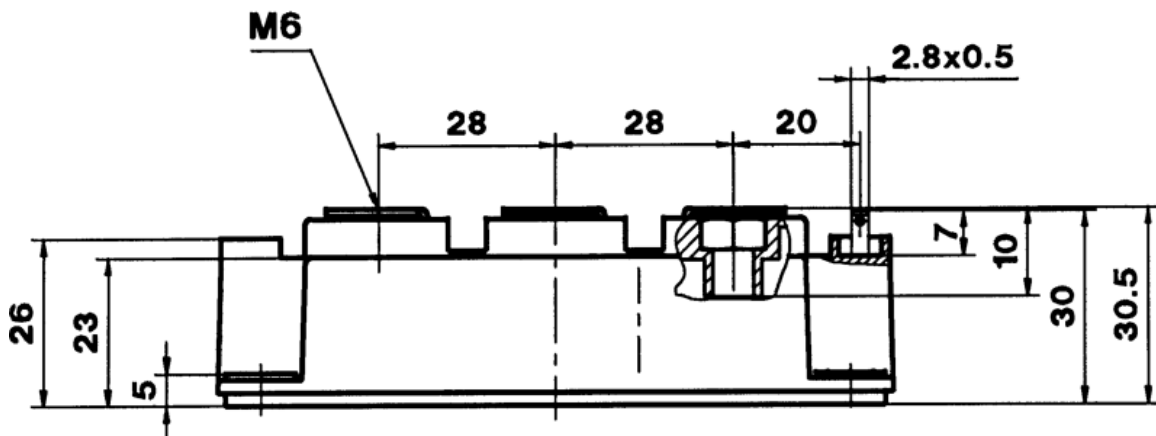
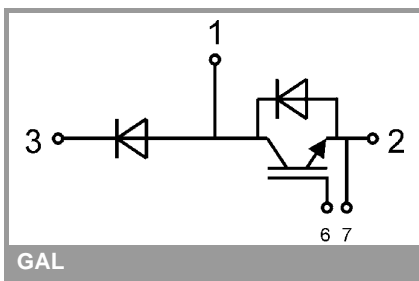

Fig. 12: Typ. CAL diode peak reverse recovery charge



Semitrans 3



GAL

This is an electrostatic discharge sensitive device (ESDS), international standard IEC 60747-1, Chapter IX.

This technical information specifies semiconductor devices but promises no characteristics. No warranty or guarantee expressed or implied is made regarding delivery, performance or suitability.